

## LME49725 PowerWise® Dual High Performance, High Fidelity Audio Operational Amplifier

Check for Samples: [LME49725](#)

### FEATURES

- Optimized for Superior Audio Signal Fidelity
- Output Short Circuit Protection
- PSRR and CMRR Exceed 120dB (Typ)

### APPLICATIONS

- Audio Amplification
- Preamplifiers
- Multimedia
- Phono Preamplifiers
- Professional Audio
- Equalization and Crossover Networks
- Line Drivers
- Line Receivers
- Active Filters

### KEY SPECIFICATIONS

- Power Supply Voltage Range:  $\pm 4.5\text{V}$  to  $\pm 18\text{V}$
- THD+N ( $A_V = 1$ ,  $V_{OUT} = 3V_{RMS}$ ,  $f_{IN} = 1\text{kHz}$ )
  - $R_L = 2\text{k}\Omega$ : 0.00004% (Typ)
  - $R_L = 600\Omega$ : 0.00004% (Typ)
- Quiescent Current per Amplifier: 3.0 mA (Typ)
- Input Noise Density: 3.3 nV/ $\sqrt{\text{Hz}}$  (Typ)
- Slew Rate:  $\pm 15\text{ V}/\mu\text{s}$  (Typ)
- Gain Bandwidth Product: 40 MHz (Typ)
- Open Loop Gain ( $R_L = 600\Omega$ ): 135 dB (Typ)
- Input Bias Current: 15 nA (Typ)
- Input Offset Voltage: 0.5 mV (Typ)
- DC Gain Linearity Error: 0.000009 % (Typ)

### DESCRIPTION

The LME49725 is part of the ultra-low distortion, low noise, high slew rate operational amplifier series optimized and fully specified for high performance, high fidelity applications. Combining advanced leading-edge process technology with state-of-the-art circuit design, the LME49725 audio operational amplifiers deliver superior audio signal amplification for outstanding audio performance. The LME49725 combines extremely low voltage noise density (3.3nV/ $\sqrt{\text{Hz}}$ ) with vanishingly low THD+N (0.00004%) to easily satisfy the most demanding audio applications. To ensure that the most challenging loads are driven without compromise, the LME49725 has a high slew rate of  $\pm 15\text{V}/\mu\text{s}$  and an output current capability of  $\pm 22\text{mA}$ . Further, dynamic range is maximized by an output stage that drives 2k $\Omega$  loads to within 1V of either power supply voltage and to within 1.4V when driving 600 $\Omega$  loads.

Part of the PowerWise® family of energy efficient solutions, the LME49725 consumes only 3.0mA of supply current per amplifier while providing superior performance to high performance, high fidelity applications.

The LME49725's outstanding CMRR (120dB), PSRR (120dB), and  $V_{OS}$  (0.5mV) give the amplifier excellent operational amplifier DC performance.

The LME49725 has a wide supply range of  $\pm 4.5\text{V}$  to  $\pm 18\text{V}$ . Over this supply range the LME49725's input circuitry maintains excellent common-mode and power supply rejection, as well as maintaining its low input bias current. The LME49725 is unity gain stable. This audio operational amplifier achieves outstanding AC performance while driving complex loads with values as high as 100pF.

The LME49725 is available in 8-lead narrow body SOIC.



Please be aware that an important notice concerning availability, standard warranty, and use in critical applications of Texas Instruments semiconductor products and disclaimers thereto appears at the end of this data sheet.

All trademarks are the property of their respective owners.

## Connection Diagram

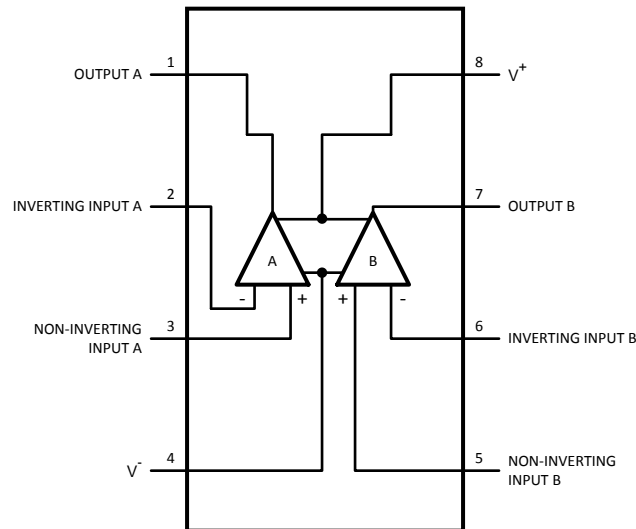

**Figure 1. SOIC Package**  
See Package Number D0008A



These devices have limited built-in ESD protection. The leads should be shorted together or the device placed in conductive foam during storage or handling to prevent electrostatic damage to the MOS gates.

## Absolute Maximum Ratings<sup>(1)(2)</sup>

Power Supply Voltage ( $V_S = V^+ - V^-$ )		38V
Storage Temperature		-65°C to 150°C
Input Voltage		(V-)-0.7V to (V+)+0.7V
Differential Input Voltage		±0.7V
Output Short Circuit <sup>(3)</sup>		Continuous
Power Dissipation		Internally Limited
ESD Rating <sup>(4)</sup>		2000V
ESD Rating <sup>(5)</sup>	Pins 1, 4, 7 and 8	200V
	Pins 2, 3, 5 and 6	100V
Junction Temperature		150°C
Thermal Resistance	$\theta_{JA}$ (SOIC)	145°C/W
Temperature Range ( $T_{MIN} \leq T_A \leq T_{MAX}$ )		-40°C ≤ $T_A$ ≤ 85°C
Supply Voltage Range		±4.5V ≤ $V_S$ ≤ ±18V

- (1) "Absolute Maximum Ratings indicate limits beyond which damage to the device may occur, including inoperability and degradation of device reliability and/or performance. Functional operation of the device and/or non-degradation at the Absolute Maximum Ratings or other conditions beyond those indicated in the Recommended Operating Conditions is not implied. The Recommended Operating Conditions indicate conditions at which the device is functional and the device should not be operated beyond such conditions. All voltages are measured with respect to the ground pin, unless otherwise specified.
- (2) If Military/Aerospace specified devices are required, please contact the TI Sales Office/Distributors for availability and specifications.
- (3) The maximum power dissipation must be derated at elevated temperatures and is dictated by  $T_{JMAX}$ ,  $\theta_{JA}$ , and the ambient temperature,  $T_A$ . The maximum allowable power dissipation is  $P_{DMAX} = (T_{JMAX} - T_A) / \theta_{JA}$  or the number given in Absolute Maximum Ratings, whichever is lower.
- (4) Human body model, applicable std. JESD22-A114C.
- (5) Machine model, applicable std. JESD22-A115-A.

**Electrical Characteristics for the LME49725<sup>(1)</sup>**

 The specifications apply for  $V_S = \pm 15V$ ,  $R_L = 2k\Omega$ ,  $f_{IN} = 1kHz$ ,  $T_A = 25^\circ C$ , unless otherwise specified.

Parameter		Test Conditions	LME49725		Units (Limits)
			Typ <sup>(2)</sup>	Limit <sup>(3)</sup>	
THD+N	Total Harmonic Distortion + Noise	$A_V = 1$ , $V_{OUT} = 3V_{rms}$ $R_L = 2k\Omega$ $R_L = 600\Omega$	0.00004	0.0002	%
			0.00004		%
IMD	Intermodulation Distortion	$A_V = 1$ , $V_{OUT} = 3V_{RMS}$ Two-tone, 60Hz & 7kHz 4:1	0.00005		%
GBWP	Gain Bandwidth Product		40	30	MHz (min)
SR	Slew Rate		$\pm 15$	$\pm 10$	V/ $\mu s$ (min)
FPBW	Full Power Bandwidth	$V_{OUT} = 1V_{P-P}$ , $-3dB$ referenced to output magnitude at $f = 1kHz$	7		MHz
$t_s$	Settling time	$A_V = -1$ , 10V step, $C_L = 100pF$ 0.1% error range	1.6		$\mu s$
$e_n$	Equivalent Input Noise Voltage	$f_{BW} = 20Hz$ to 20kHz	0.4	0.8	$\mu V_{RMS}$ (max)
	Equivalent Input Noise Density	$f = 1kHz$ $f = 10Hz$	3.3 20	5.2	$nV/\sqrt{Hz}$ (max)
$i_n$	Current Noise Density	$f = 1kHz$ $f = 10Hz$	1.4		$pA/\sqrt{Hz}$
			3.5		$pA/\sqrt{Hz}$
$V_{OS}$	Offset Voltage		$\pm 0.5$	$\pm 1.0$	mV (max)
$\Delta V_{OS}/\Delta Temp$	Average Input Offset Voltage Drift vs Temperature	$-40^\circ C \leq T_A \leq 85^\circ C$	0.2		$\mu V/^\circ C$
PSRR	Average Input Offset Voltage Shift vs Power Supply Voltage	$\Delta V_S = 20V^{(4)}$	120	100	dB (min)
ISO <sub>CH-CH</sub>	Channel-to-Channel Isolation	$f_{IN} = 1kHz$ $f_{IN} = 20kHz$	118		dB
			112		dB
$I_B$	Input Bias Current	$V_{CM} = 0V$	$\pm 15$	$\pm 90$	nA (max)
$\Delta I_{OS}/\Delta Temp$	Input Bias Current Drift vs Temperature	$-40^\circ C \leq T_A \leq 85^\circ C$	0.1		nA/ $^\circ C$
$I_{OS}$	Input Offset Current	$V_{CM} = 0V$	11	65	nA (max)
$V_{IN-CM}$	Common-Mode Input Voltage Range		$\pm 13.9$	(V+)-2.0 (V-)+2.0	V (min) V (min)
CMRR	Common-Mode Rejection	$-10V < V_{cm} < 10V$	120	100	dB (min)
$Z_{IN}$	Differential Input Impedance		30		k $\Omega$
	Common Mode Input Impedance	$-10V < V_{cm} < 10V$	1000		M $\Omega$
$A_{VOL}$	Open Loop Voltage Gain	$-10V < V_{out} < 10V$ , $R_L = 600\Omega$	135	110	dB (min)
		$-10V < V_{out} < 10V$ , $R_L = 2k\Omega$	135		dB
		$-10V < V_{out} < 10V$ , $R_L = 10k\Omega$	135		dB
$V_{OUTMAX}$	Maximum Output Voltage Swing	$R_L = 600\Omega$	$\pm 13.6$	$\pm 11.5$	V (min)
		$R_L = 2k\Omega$	$\pm 13.9$		V
		$R_L = 10k\Omega$	$\pm 14.0$		V
$I_{OUT}$	Output Current	$R_L = 600\Omega$ , $V_S = \pm 17V$	$\pm 22$		mA (min)
$I_{OUT-CC}$	Instantaneous Short Circuit Current		+45 -35		mA mA

- (1) The Electrical Characteristics tables list ensured specifications under the listed Recommended Operating Conditions except as otherwise modified or specified by the *Electrical Characteristics Conditions* and/or Notes. Typical specifications are estimations only and are not ensured.
- (2) Typical values represent most likely parametric norms at  $T_A = +25^\circ C$ , and at the *Recommended Operation Conditions* at the time of product characterization and are not ensured.
- (3) Datasheet min/max specification limits are ensured by test or statistical analysis.
- (4) PSRR is measured as follows:  $V_{OS}$  is measured at two supply voltages,  $\pm 5V$  and  $\pm 15V$ ,  $PSRR = |20\log(\Delta V_{OS}/\Delta V_S)|$ .

**Electrical Characteristics for the LME49725<sup>(1)</sup> (continued)**

The specifications apply for  $V_S = \pm 15V$ ,  $R_L = 2k\Omega$ ,  $f_{IN} = 1kHz$ ,  $T_A = 25^\circ C$ , unless otherwise specified.

Parameter		Test Conditions	LME49725		Units (Limits)
			Typ <sup>(2)</sup>	Limit <sup>(3)</sup>	
$R_{OUT}$	Output Impedance	$f_{IN} = 10kHz$ Closed-Loop Open-Loop	0.01 18		$\Omega$ $\Omega$
$C_{LOAD}$	Capacitive Load Drive Overshoot	100pF	16		%
$I_S$	Quiescent Current per Amplifier	$I_{OUT} = 0mA$	3.0	4.5	mA (max)
$f_C$	1/f Corner Frequency		120		Hz

Typical Performance Characteristics

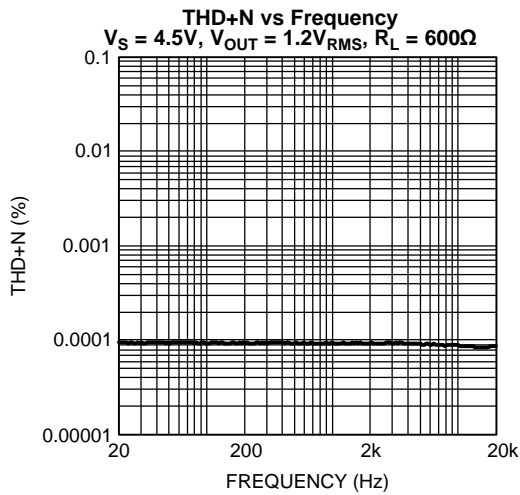

Figure 2.

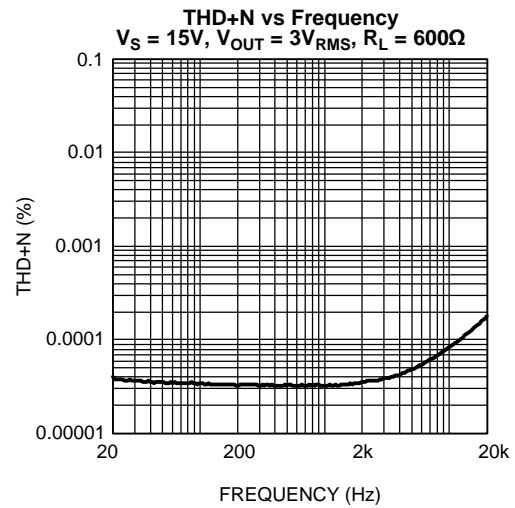

Figure 3.

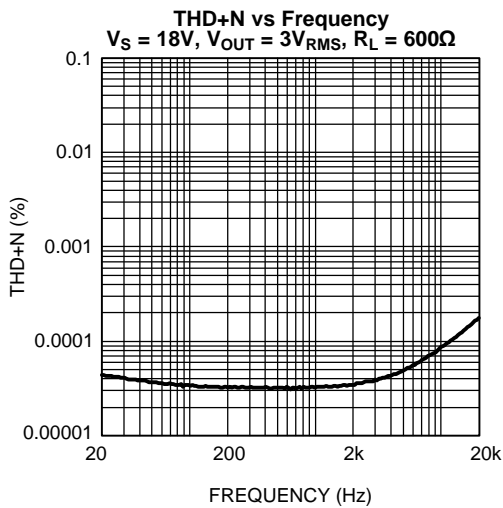

Figure 4.

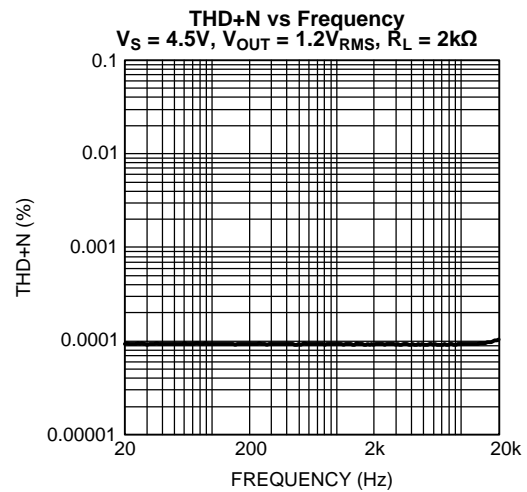

Figure 5.

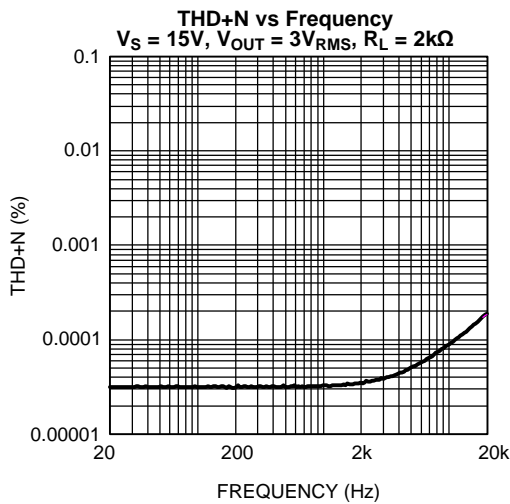

Figure 6.

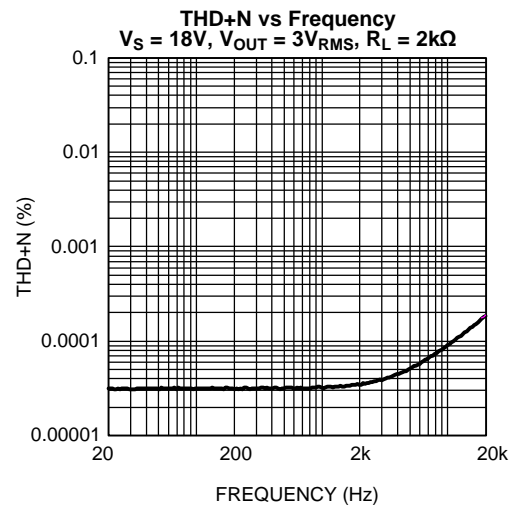

Figure 7.

**Typical Performance Characteristics (continued)**

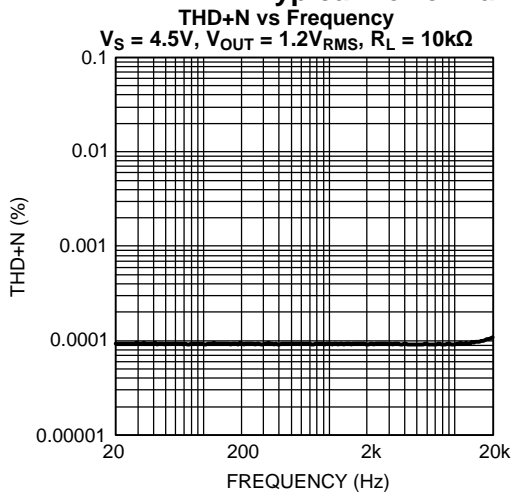

Figure 8.

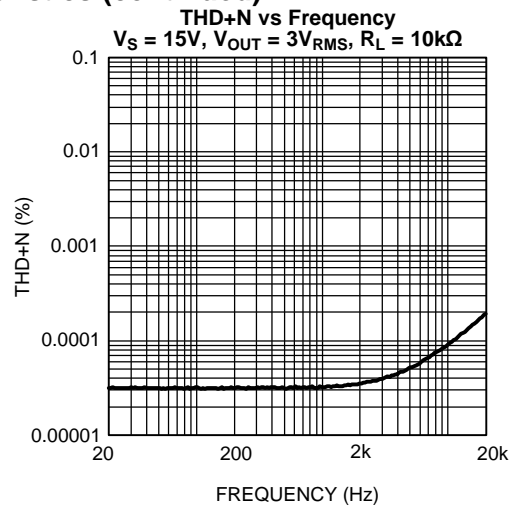

Figure 9.

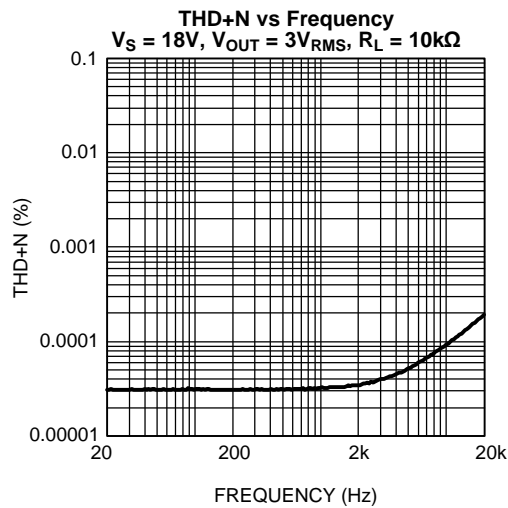

Figure 10.

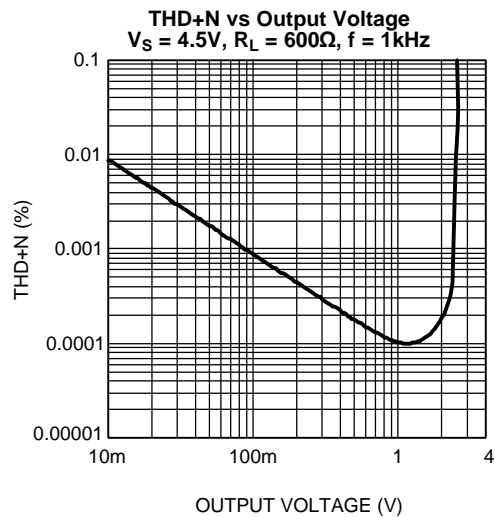

Figure 11.

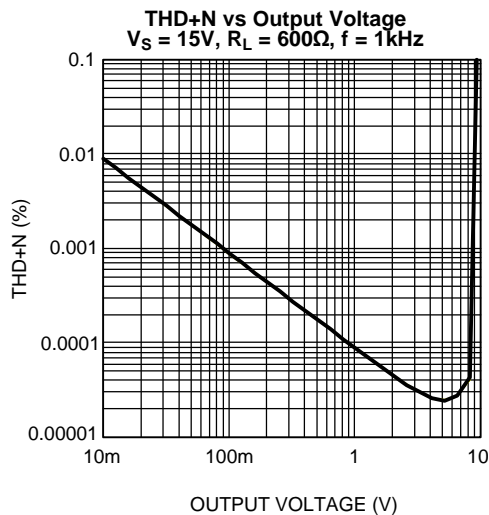

Figure 12.

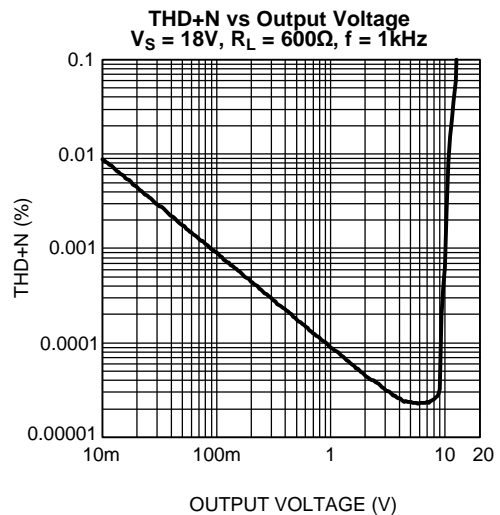

Figure 13.

Typical Performance Characteristics (continued)

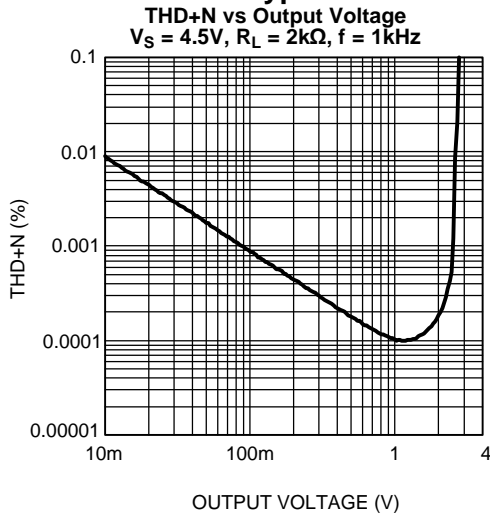

Figure 14.

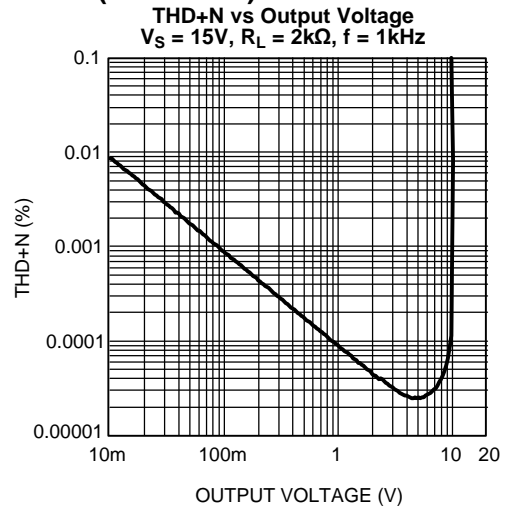

Figure 15.

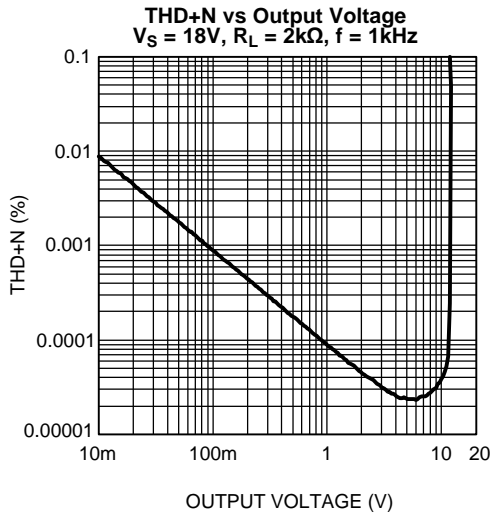

Figure 16.

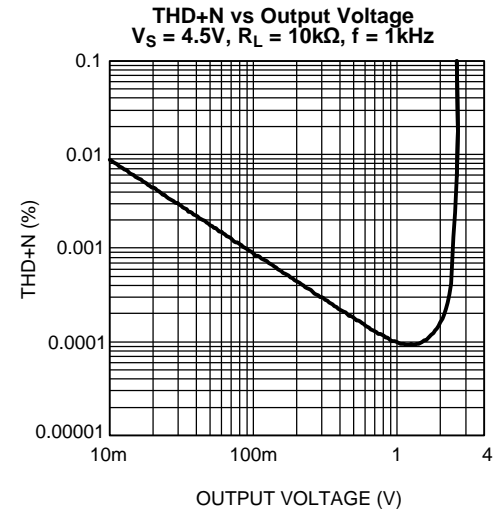

Figure 17.

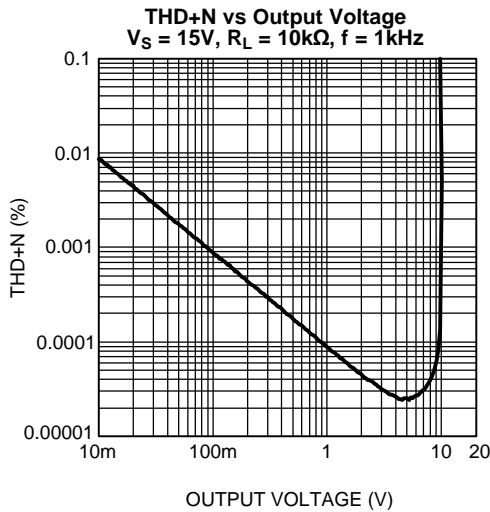

Figure 18.

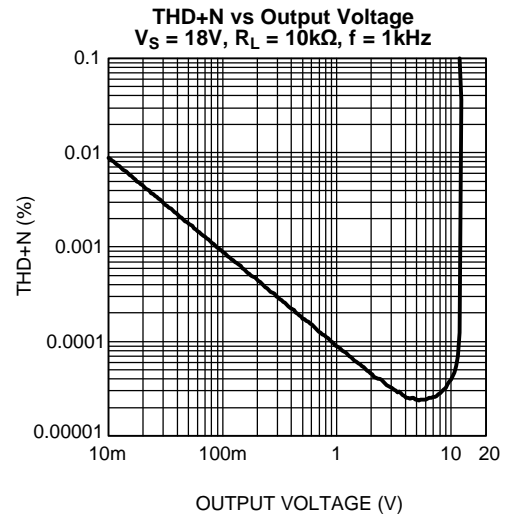
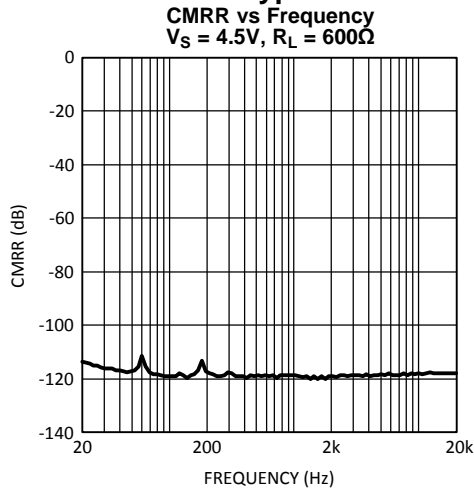
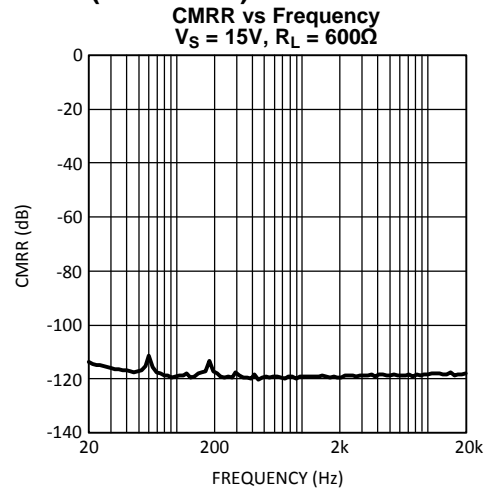

Figure 19.

**Typical Performance Characteristics (continued)**



**Figure 20.**



**Figure 21.**

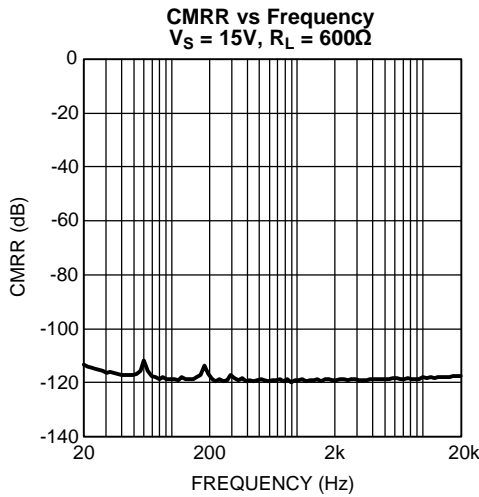

**Figure 22.**

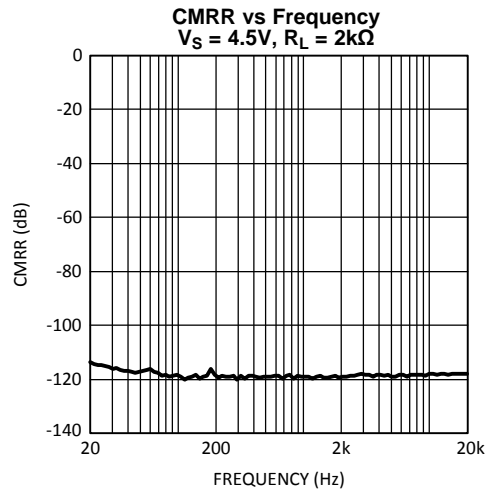

**Figure 23.**

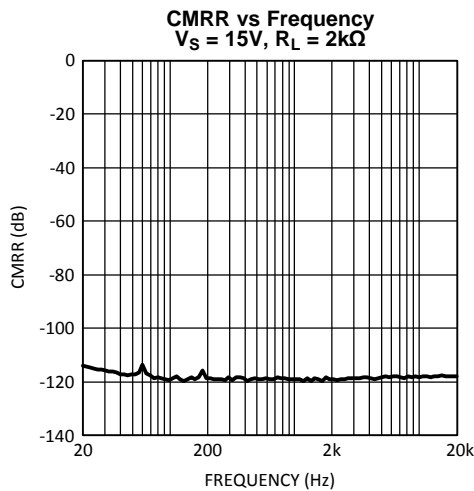

**Figure 24.**

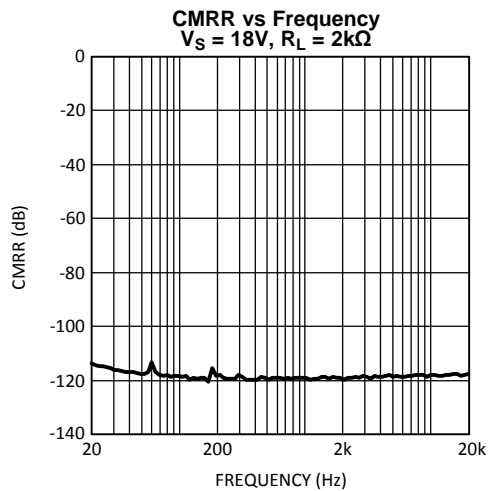

**Figure 25.**



Typical Performance Characteristics (continued)

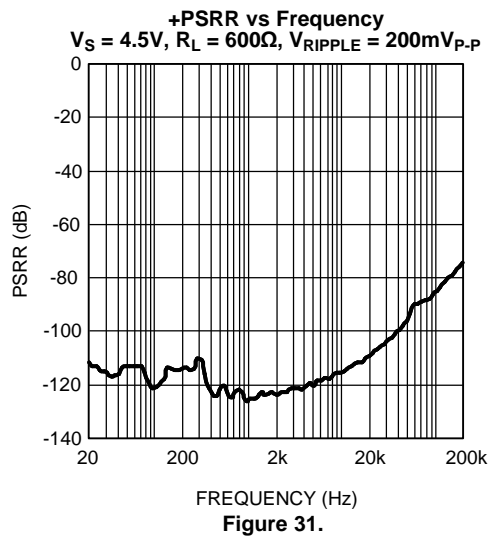
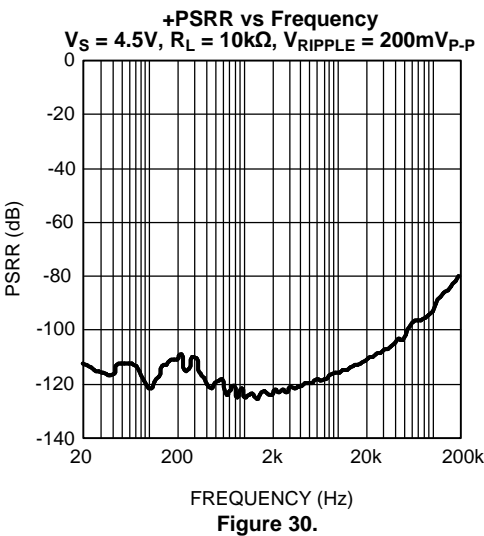
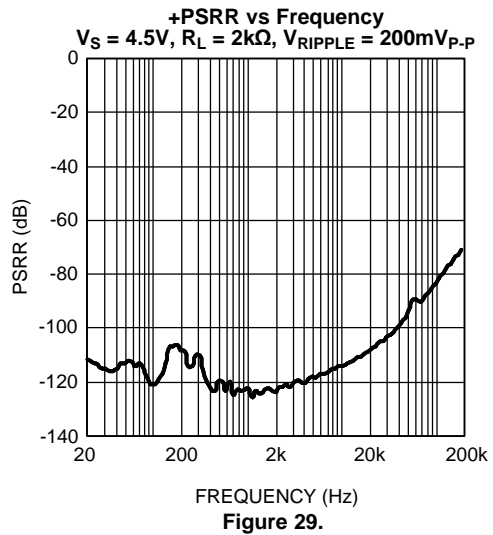
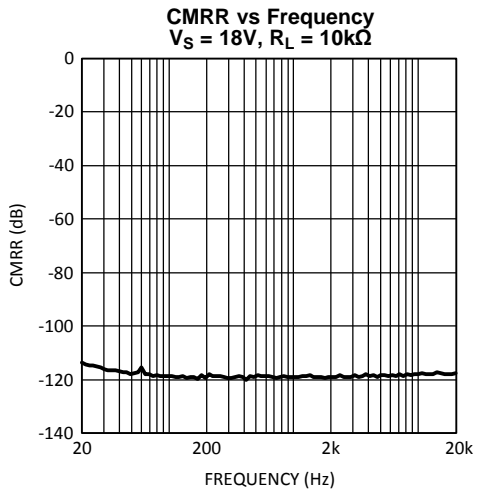
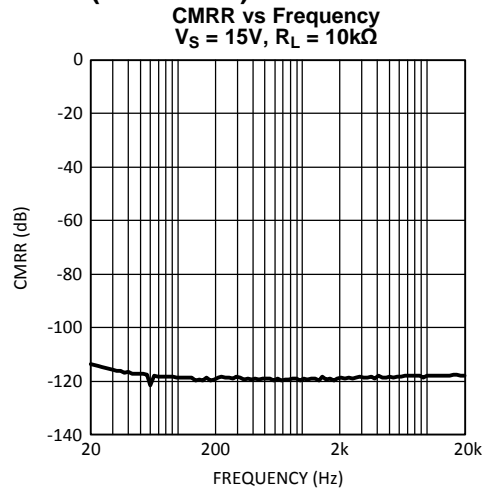
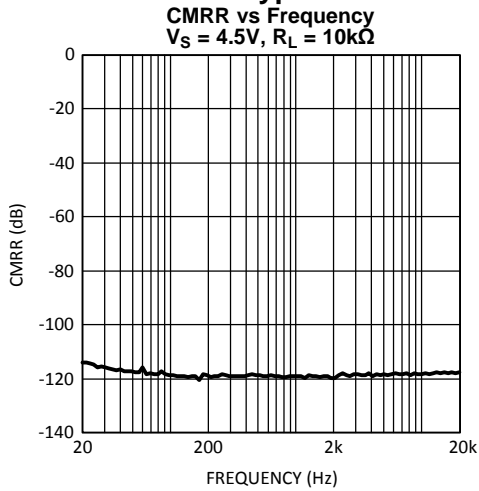

**Typical Performance Characteristics (continued)**

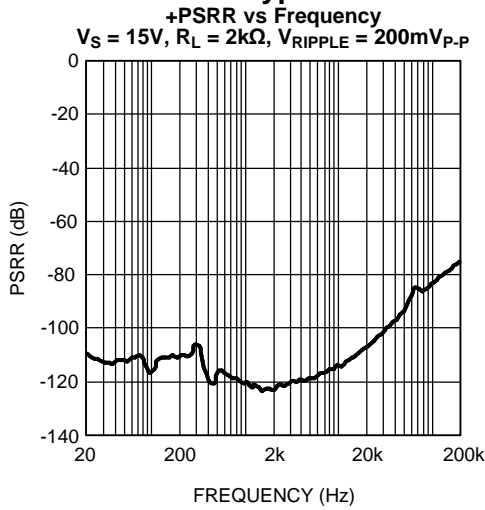

Figure 32.

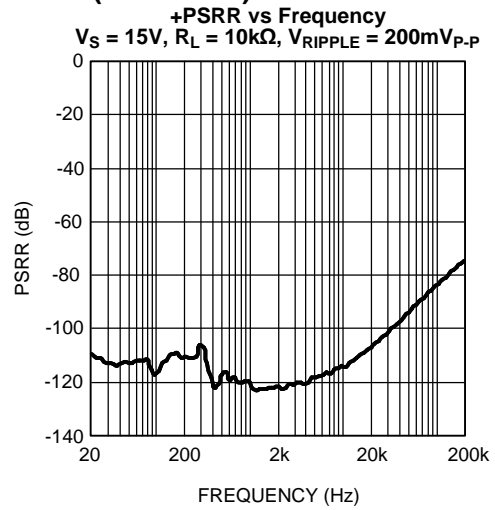

Figure 33.

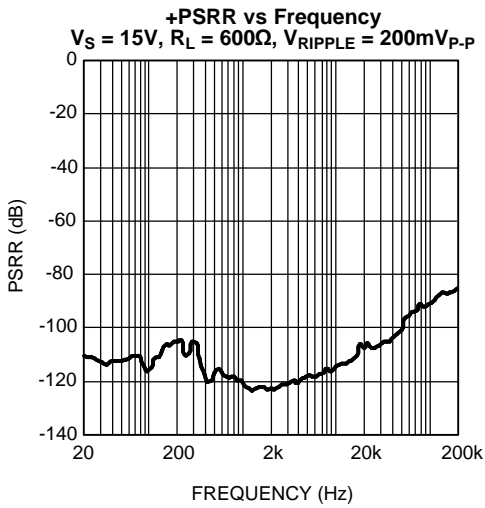

Figure 34.

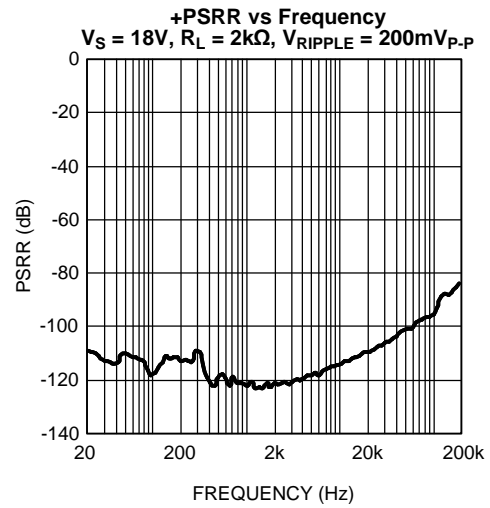

Figure 35.

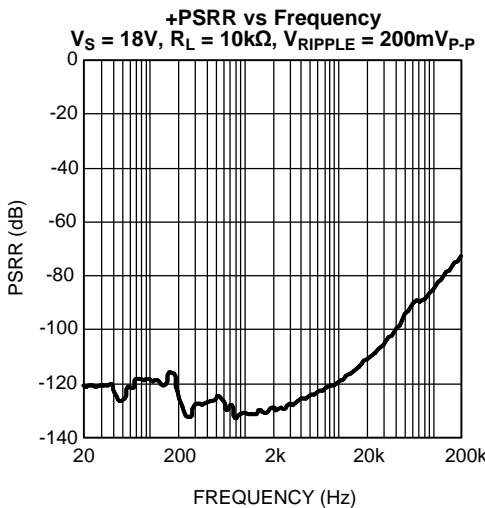

Figure 36.

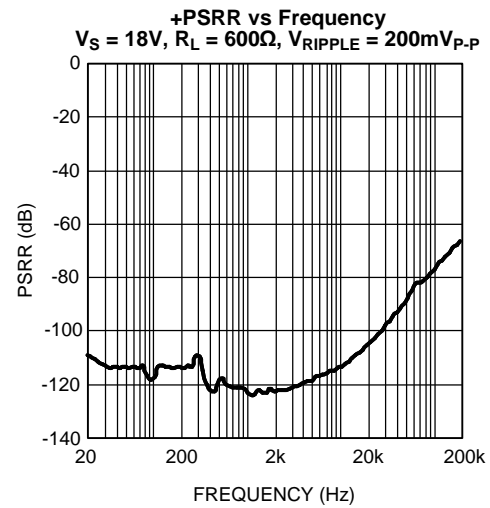

Figure 37.

Typical Performance Characteristics (continued)

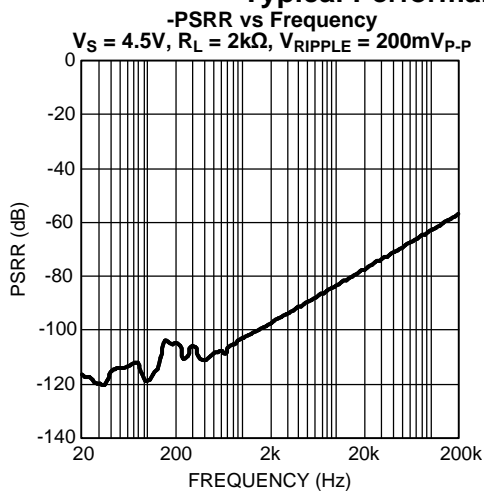

Figure 38.

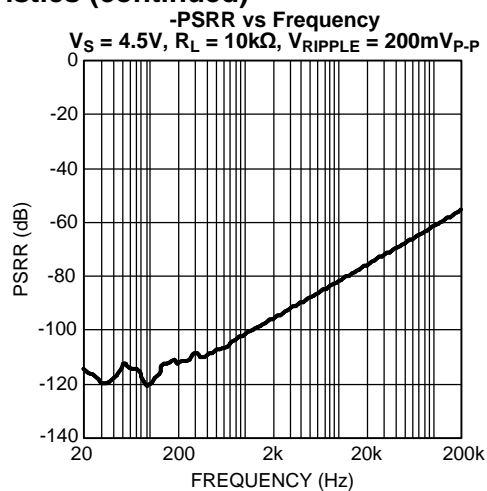

Figure 39.

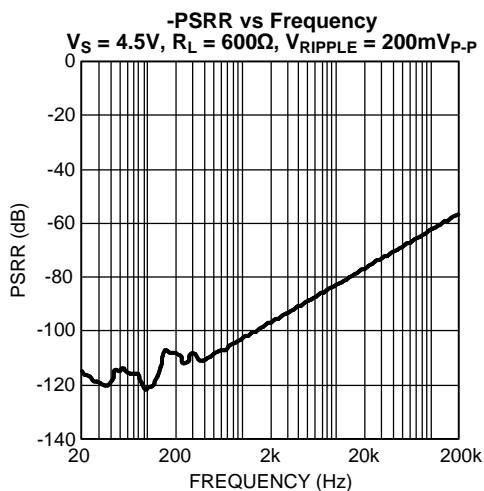

Figure 40.

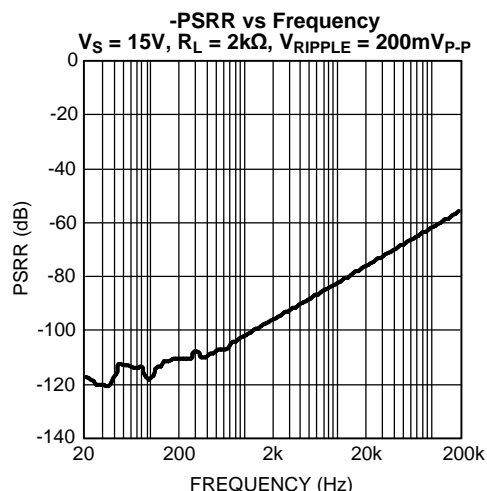

Figure 41.

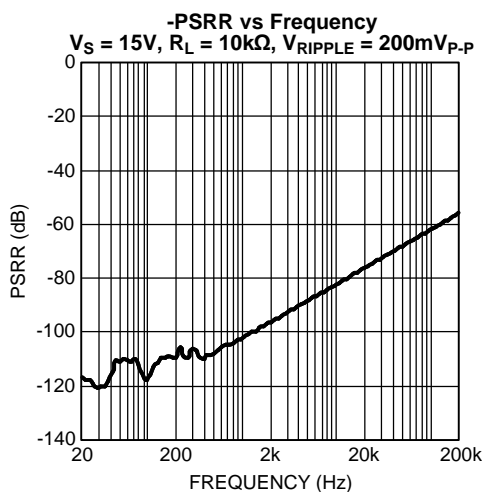

Figure 42.

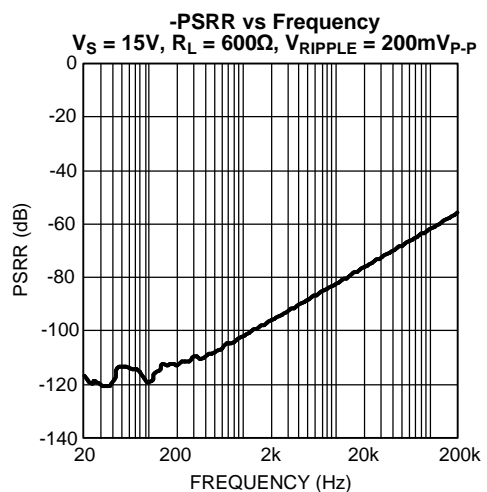

Figure 43.

**Typical Performance Characteristics (continued)**

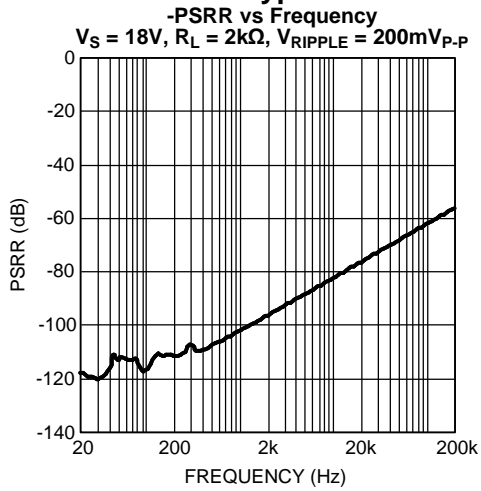

Figure 44.

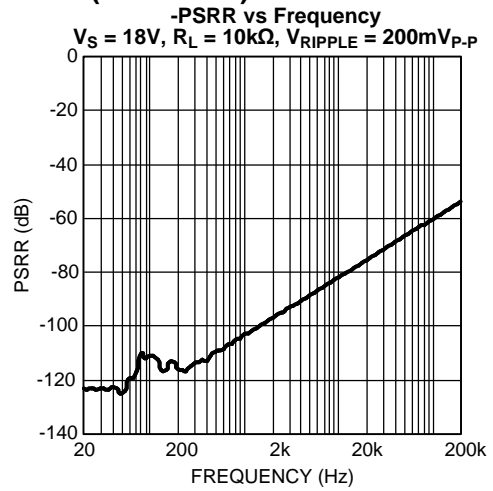

Figure 45.

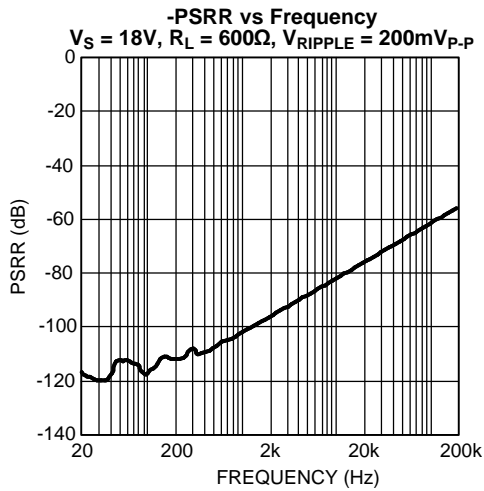

Figure 46.

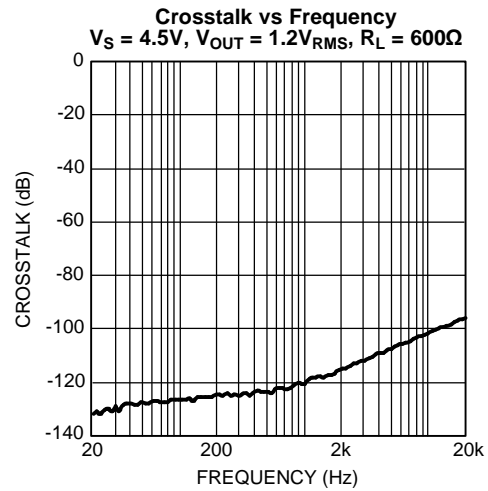

Figure 47.

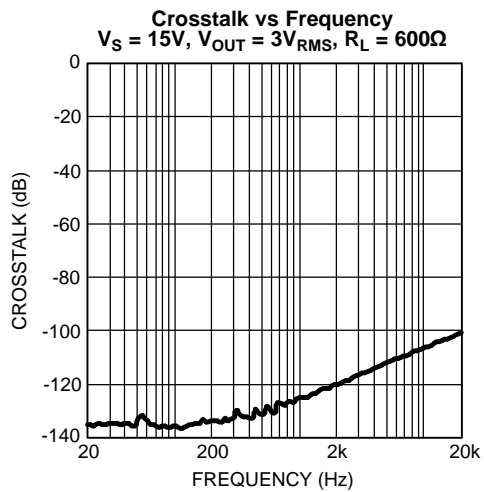

Figure 48.

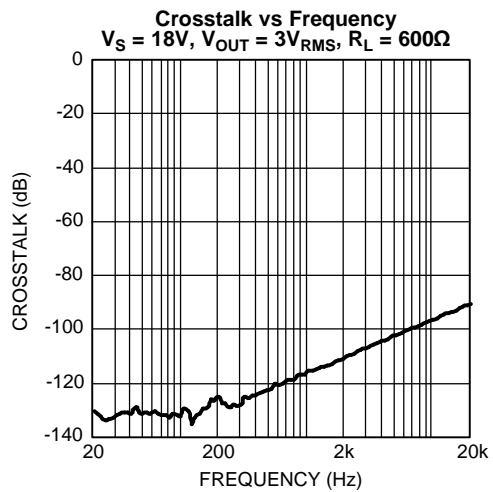

Figure 49.

Typical Performance Characteristics (continued)

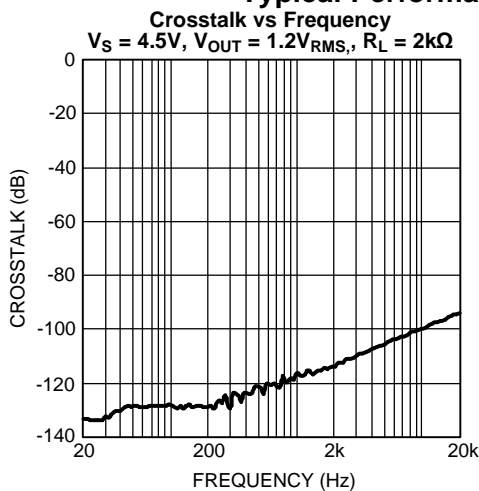

Figure 50.

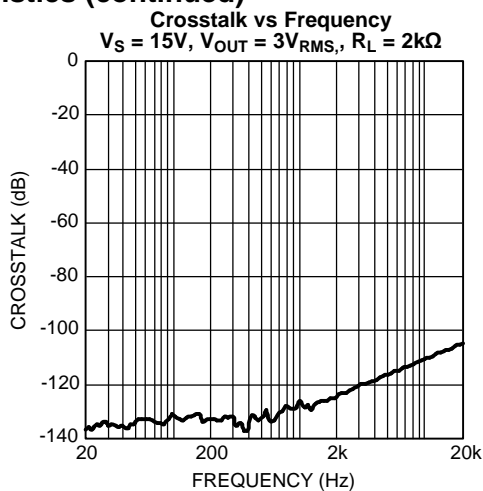

Figure 51.

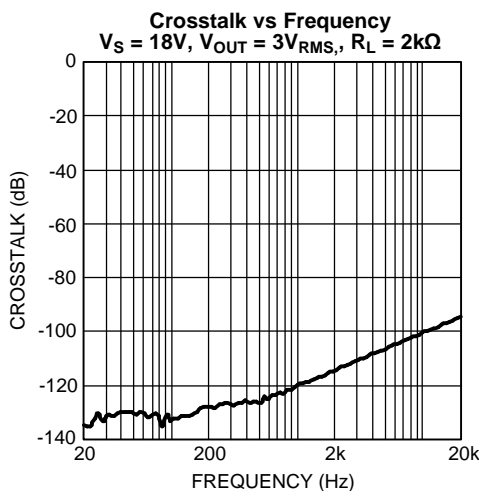

Figure 52.

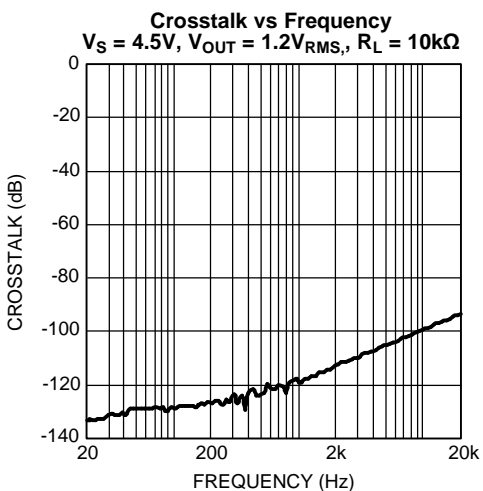

Figure 53.

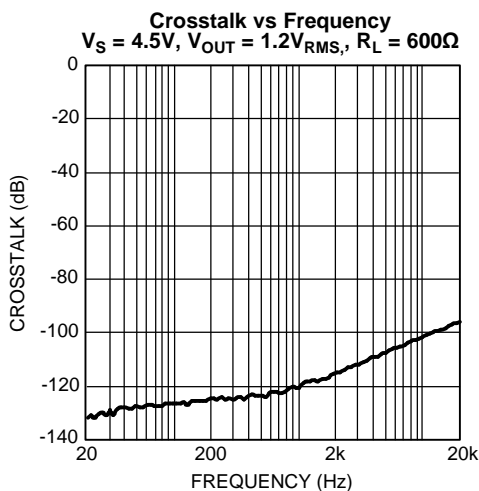

Figure 54.

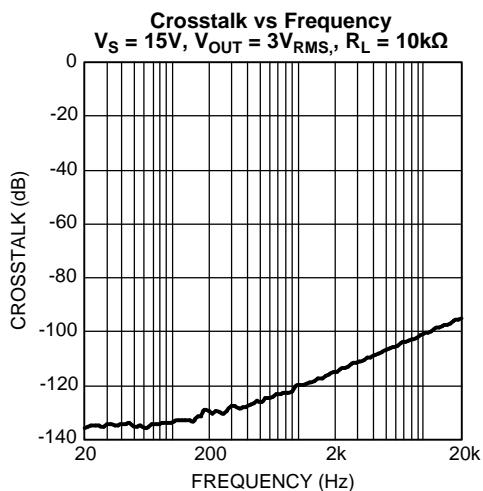

Figure 55.

**Typical Performance Characteristics (continued)**

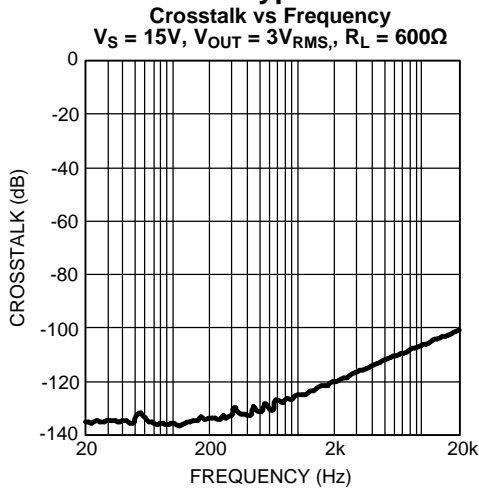

Figure 56.

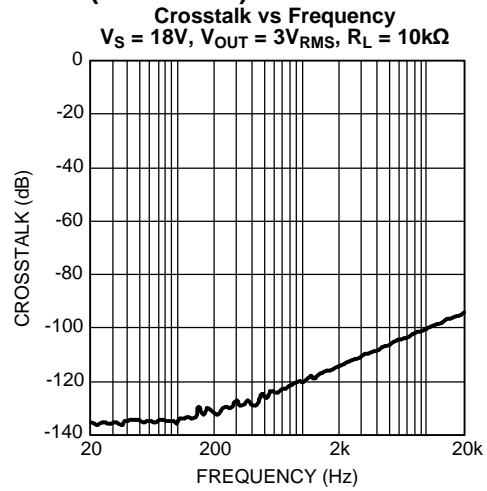

Figure 57.

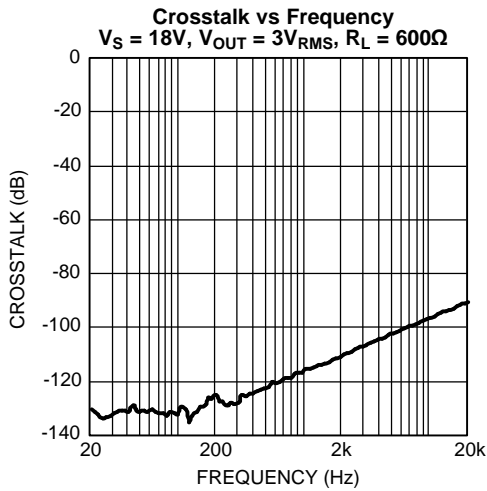

Figure 58.

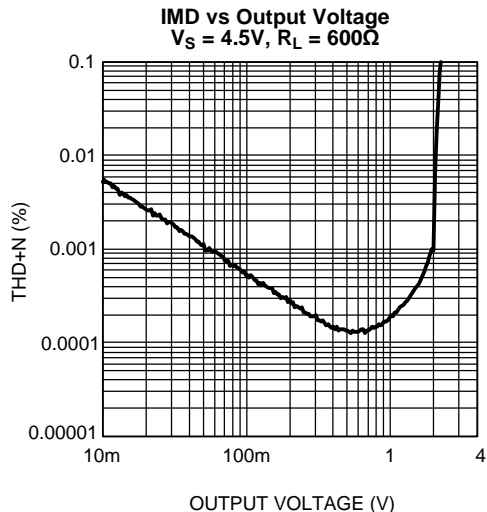

Figure 59.

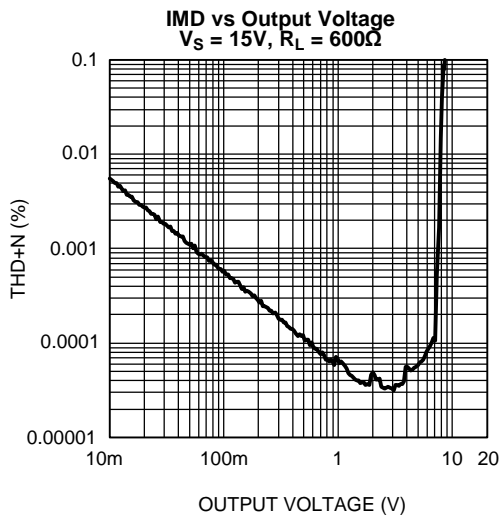

Figure 60.

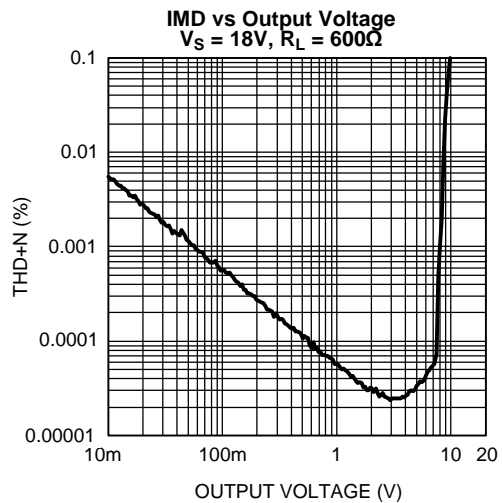

Figure 61.

Typical Performance Characteristics (continued)

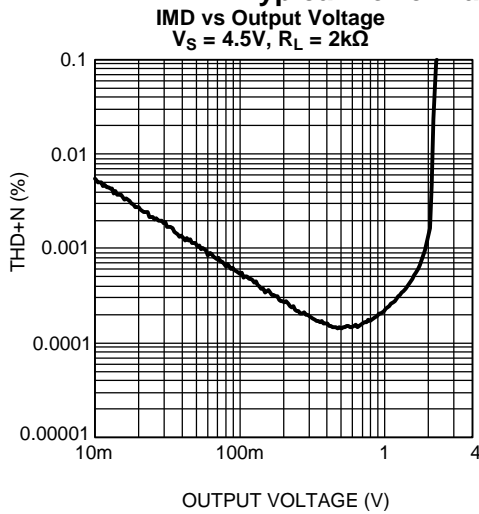

Figure 62.

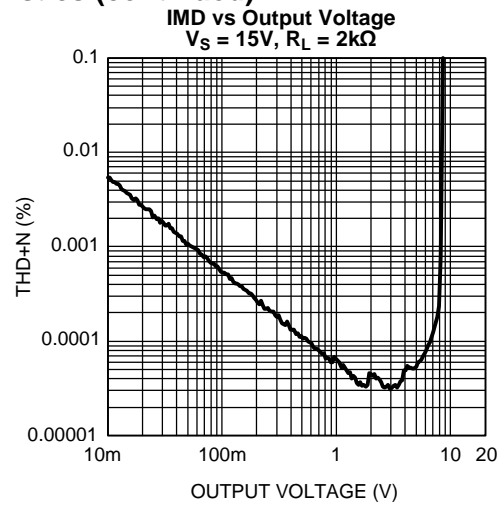

Figure 63.

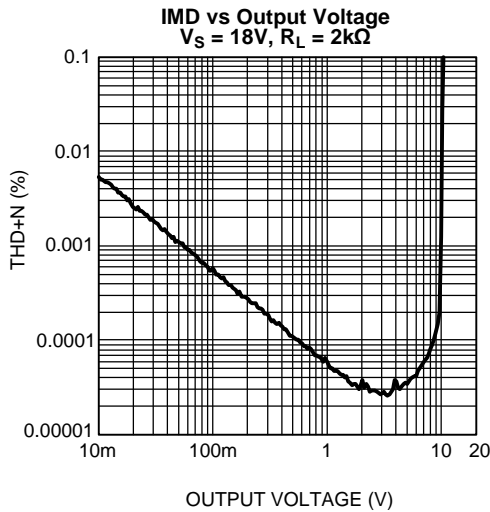

Figure 64.

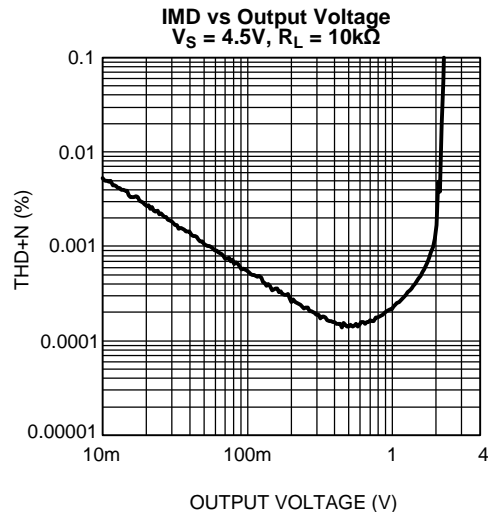

Figure 65.

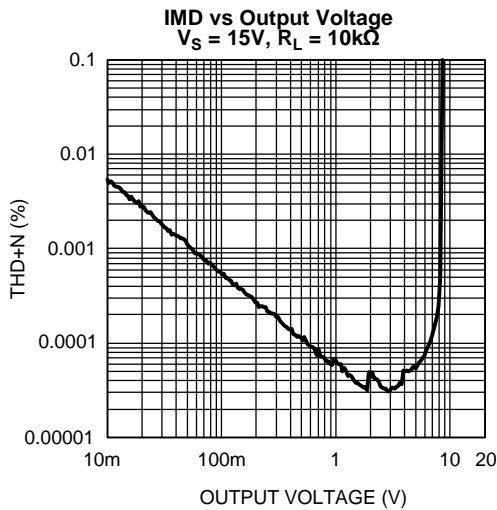

Figure 66.

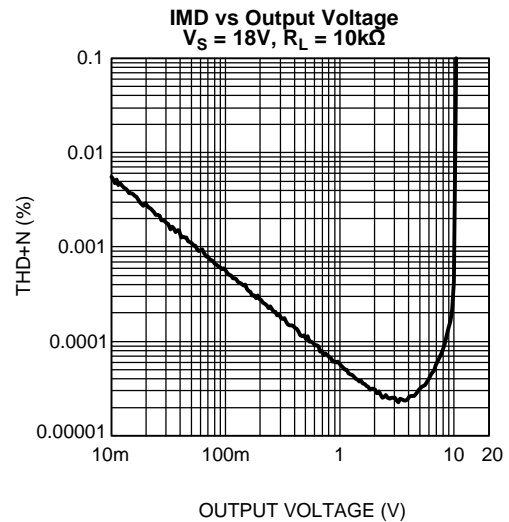
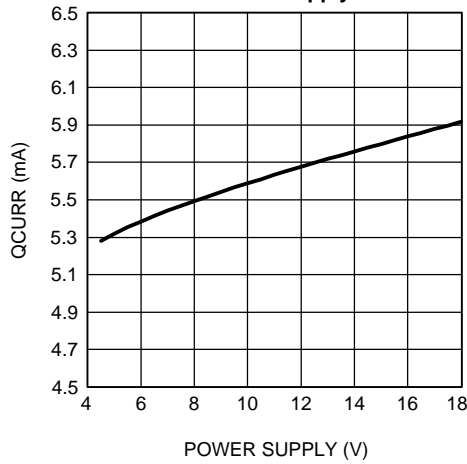

Figure 67.

**Typical Performance Characteristics (continued)**

**Total Quiescent Current vs Power Supply**



**Figure 68.**

**Voltage Noise Density vs Frequency**  
 $V_{CC} = 15V, V_{EE} = -15V, \text{No Load}$

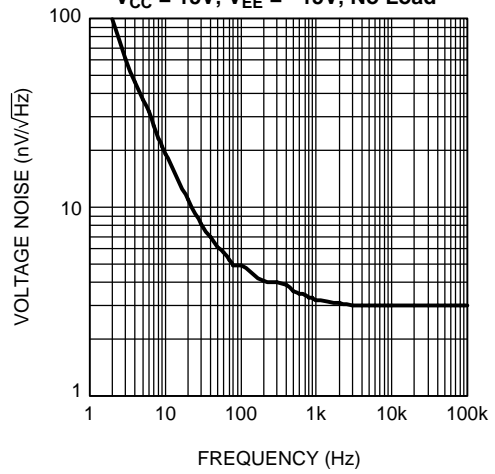

**Figure 69.**

**Current Noise vs Frequency**  
 $V_{CC} = 15V, V_{EE} = -15V, \text{No Load}$

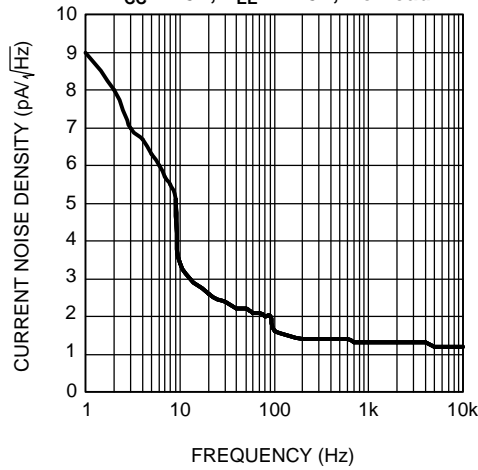

**Figure 70.**



## APPLICATION INFORMATION

### OPERATING RATINGS AND BASIC DESIGN GUIDELINES

The LME49725 has a supply voltage range from +9V to +36V single supply or  $\pm 4.5V$  to  $\pm 18V$  dual supply.

Bypass capacitors for the supplies should be placed as close to the amplifier as possible. This will help minimize any inductance between the power supply and the supply pins. In addition to a 10 $\mu F$  capacitor, a 0.1 $\mu F$  capacitor is also recommended.

The amplifier's inputs lead lengths should also be as short as possible. If the op amp does not have a bypass capacitor, it may oscillate.

### Demonstration Board Schematic

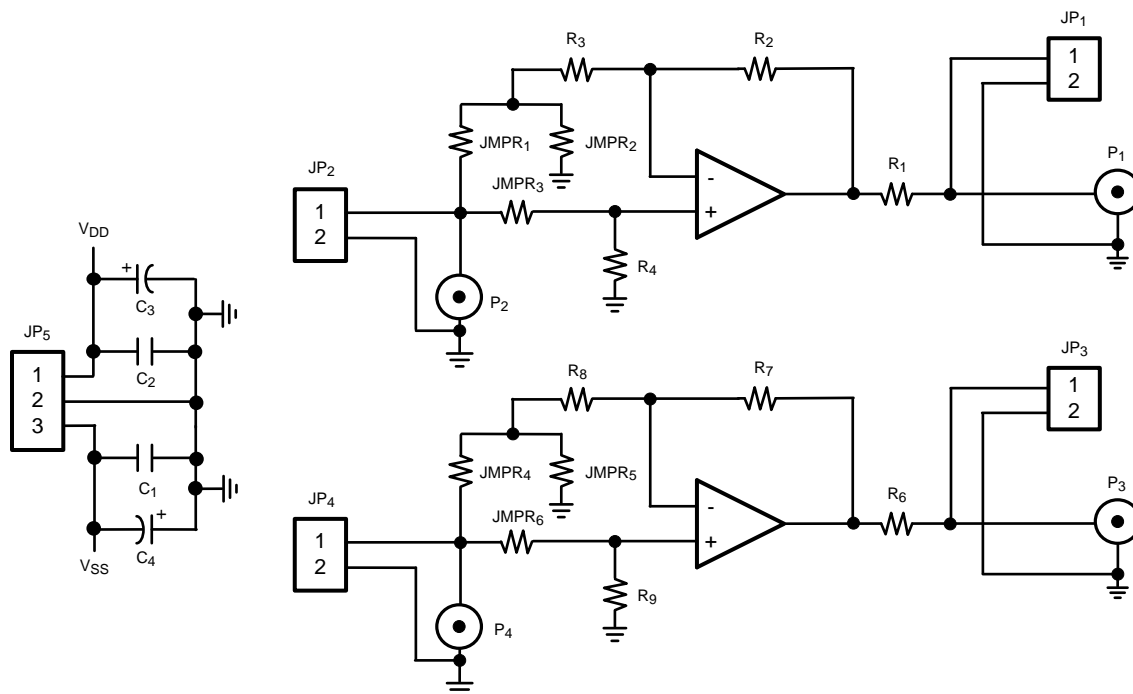

### Bill of Materials For Demonstration Board (Inverting Configuration)

Description	Designator <sup>(1)</sup>	Part Number	Mfg
Ceramic Capacitor 0.1 $\mu F$ , 10% 50V 0805 SMD	C1, C2	C0805C104K3RAC7533	Kemet
Tantalum Capacitor 10 $\mu F$ , 10% 20V, B-size	C3, C4	T491B106K025AT	Kemet
Resistor 0 $\Omega$ , 1/8W, 1% 0805 SMD	JMPR1, JMPR4, R1, R4, R6, R9	CRCW0805000020EA	Vishay
Resistor 10k $\Omega$ , 1/8W, 1% 0805 SMD	R2, R3, R8, R7	CRCW080510K0FKEA	Vishay
Header, 2-Pin	JP1, JP2, JP3, JP4		
Header, 3-Pin	JP5		
SMA stand-up connectors	P1-P4 (Optional)	132134	Amphenol COnnex

(1) Do not stuff JMPR2, JMPR3, JMPR5, and JMPR6.

## Demonstration Board Layout

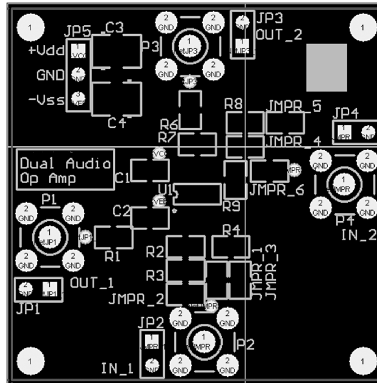

Figure 71. Silkscreen Layer

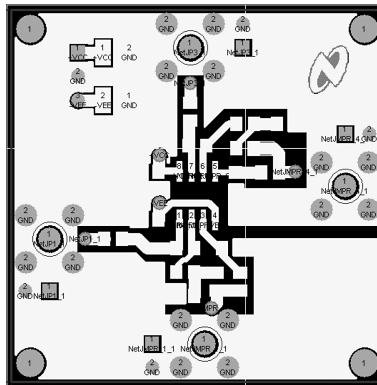

Figure 72. Top Layer

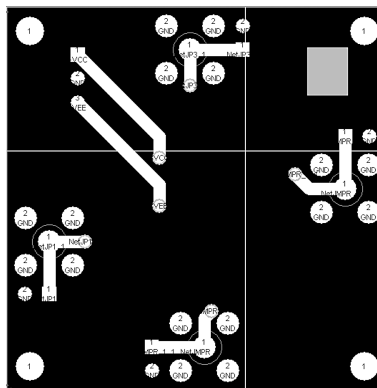

Figure 73. Bottom Layer

**REVISION HISTORY**

<b>Rev</b>	<b>Date</b>	<b>Description</b>
1.0	04/03/08	Initial release.
A	04/03/13	Changed layout of National Data Sheet to TI format.

**PACKAGING INFORMATION**

Orderable Device	Status (1)	Package Type	Package Drawing	Pins	Package Qty	Eco Plan (2)	Lead/Ball Finish	MSL Peak Temp (3)	Op Temp (°C)	Top-Side Markings (4)	Samples
LME49725MA/NOPB	ACTIVE	SOIC	D	8	95	Green (RoHS & no Sb/Br)	CU SN	Level-1-260C-UNLIM	-40 to 85	L49725 MA	<a href="#">Samples</a>
LME49725MAX/NOPB	ACTIVE	SOIC	D	8	2500	Green (RoHS & no Sb/Br)	CU SN	Level-1-260C-UNLIM	-40 to 85	L49725 MA	<a href="#">Samples</a>

(1) The marketing status values are defined as follows:

**ACTIVE:** Product device recommended for new designs.

**LIFEBUY:** TI has announced that the device will be discontinued, and a lifetime-buy period is in effect.

**NRND:** Not recommended for new designs. Device is in production to support existing customers, but TI does not recommend using this part in a new design.

**PREVIEW:** Device has been announced but is not in production. Samples may or may not be available.

**OBSOLETE:** TI has discontinued the production of the device.

(2) Eco Plan - The planned eco-friendly classification: Pb-Free (RoHS), Pb-Free (RoHS Exempt), or Green (RoHS & no Sb/Br) - please check <http://www.ti.com/productcontent> for the latest availability information and additional product content details.

**TBD:** The Pb-Free/Green conversion plan has not been defined.

**Pb-Free (RoHS):** TI's terms "Lead-Free" or "Pb-Free" mean semiconductor products that are compatible with the current RoHS requirements for all 6 substances, including the requirement that lead not exceed 0.1% by weight in homogeneous materials. Where designed to be soldered at high temperatures, TI Pb-Free products are suitable for use in specified lead-free processes.

**Pb-Free (RoHS Exempt):** This component has a RoHS exemption for either 1) lead-based flip-chip solder bumps used between the die and package, or 2) lead-based die adhesive used between the die and leadframe. The component is otherwise considered Pb-Free (RoHS compatible) as defined above.

**Green (RoHS & no Sb/Br):** TI defines "Green" to mean Pb-Free (RoHS compatible), and free of Bromine (Br) and Antimony (Sb) based flame retardants (Br or Sb do not exceed 0.1% by weight in homogeneous material)

(3) MSL, Peak Temp. -- The Moisture Sensitivity Level rating according to the JEDEC industry standard classifications, and peak solder temperature.

(4) Multiple Top-Side Markings will be inside parentheses. Only one Top-Side Marking contained in parentheses and separated by a "~" will appear on a device. If a line is indented then it is a continuation of the previous line and the two combined represent the entire Top-Side Marking for that device.

**Important Information and Disclaimer:** The information provided on this page represents TI's knowledge and belief as of the date that it is provided. TI bases its knowledge and belief on information provided by third parties, and makes no representation or warranty as to the accuracy of such information. Efforts are underway to better integrate information from third parties. TI has taken and continues to take reasonable steps to provide representative and accurate information but may not have conducted destructive testing or chemical analysis on incoming materials and chemicals. TI and TI suppliers consider certain information to be proprietary, and thus CAS numbers and other limited information may not be available for release.

In no event shall TI's liability arising out of such information exceed the total purchase price of the TI part(s) at issue in this document sold by TI to Customer on an annual basis.

## TAPE AND REEL INFORMATION



### QUADRANT ASSIGNMENTS FOR PIN 1 ORIENTATION IN TAPE



\*All dimensions are nominal

Device	Package Type	Package Drawing	Pins	SPQ	Reel Diameter (mm)	Reel Width W1 (mm)	A0 (mm)	B0 (mm)	K0 (mm)	P1 (mm)	W (mm)	Pin1 Quadrant
LME49725MAX/NOPB	SOIC	D	8	2500	330.0	12.4	6.5	5.4	2.0	8.0	12.0	Q1

**TAPE AND REEL BOX DIMENSIONS**



\*All dimensions are nominal

Device	Package Type	Package Drawing	Pins	SPQ	Length (mm)	Width (mm)	Height (mm)
LME49725MAX/NOPB	SOIC	D	8	2500	349.0	337.0	45.0

D (R-PDSO-G8)

PLASTIC SMALL OUTLINE



NOTES: A. All linear dimensions are in inches (millimeters).  
 B. This drawing is subject to change without notice.  
 C. Body length does not include mold flash, protrusions, or gate burrs. Mold flash, protrusions, or gate burrs shall not exceed 0.006 (0,15) each side.  
 D. Body width does not include interlead flash. Interlead flash shall not exceed 0.017 (0,43) each side.  
 E. Reference JEDEC MS-012 variation AA.

## IMPORTANT NOTICE

Texas Instruments Incorporated and its subsidiaries (TI) reserve the right to make corrections, enhancements, improvements and other changes to its semiconductor products and services per JESD46, latest issue, and to discontinue any product or service per JESD48, latest issue. Buyers should obtain the latest relevant information before placing orders and should verify that such information is current and complete. All semiconductor products (also referred to herein as "components") are sold subject to TI's terms and conditions of sale supplied at the time of order acknowledgment.

TI warrants performance of its components to the specifications applicable at the time of sale, in accordance with the warranty in TI's terms and conditions of sale of semiconductor products. Testing and other quality control techniques are used to the extent TI deems necessary to support this warranty. Except where mandated by applicable law, testing of all parameters of each component is not necessarily performed.

TI assumes no liability for applications assistance or the design of Buyers' products. Buyers are responsible for their products and applications using TI components. To minimize the risks associated with Buyers' products and applications, Buyers should provide adequate design and operating safeguards.

TI does not warrant or represent that any license, either express or implied, is granted under any patent right, copyright, mask work right, or other intellectual property right relating to any combination, machine, or process in which TI components or services are used. Information published by TI regarding third-party products or services does not constitute a license to use such products or services or a warranty or endorsement thereof. Use of such information may require a license from a third party under the patents or other intellectual property of the third party, or a license from TI under the patents or other intellectual property of TI.

Reproduction of significant portions of TI information in TI data books or data sheets is permissible only if reproduction is without alteration and is accompanied by all associated warranties, conditions, limitations, and notices. TI is not responsible or liable for such altered documentation. Information of third parties may be subject to additional restrictions.

Resale of TI components or services with statements different from or beyond the parameters stated by TI for that component or service voids all express and any implied warranties for the associated TI component or service and is an unfair and deceptive business practice. TI is not responsible or liable for any such statements.

Buyer acknowledges and agrees that it is solely responsible for compliance with all legal, regulatory and safety-related requirements concerning its products, and any use of TI components in its applications, notwithstanding any applications-related information or support that may be provided by TI. Buyer represents and agrees that it has all the necessary expertise to create and implement safeguards which anticipate dangerous consequences of failures, monitor failures and their consequences, lessen the likelihood of failures that might cause harm and take appropriate remedial actions. Buyer will fully indemnify TI and its representatives against any damages arising out of the use of any TI components in safety-critical applications.

In some cases, TI components may be promoted specifically to facilitate safety-related applications. With such components, TI's goal is to help enable customers to design and create their own end-product solutions that meet applicable functional safety standards and requirements. Nonetheless, such components are subject to these terms.

No TI components are authorized for use in FDA Class III (or similar life-critical medical equipment) unless authorized officers of the parties have executed a special agreement specifically governing such use.

Only those TI components which TI has specifically designated as military grade or "enhanced plastic" are designed and intended for use in military/aerospace applications or environments. Buyer acknowledges and agrees that any military or aerospace use of TI components which have **not** been so designated is solely at the Buyer's risk, and that Buyer is solely responsible for compliance with all legal and regulatory requirements in connection with such use.

TI has specifically designated certain components as meeting ISO/TS16949 requirements, mainly for automotive use. In any case of use of non-designated products, TI will not be responsible for any failure to meet ISO/TS16949.

### Products

Audio	<a href="http://www.ti.com/audio">www.ti.com/audio</a>
Amplifiers	<a href="http://amplifier.ti.com">amplifier.ti.com</a>
Data Converters	<a href="http://dataconverter.ti.com">dataconverter.ti.com</a>
DLP® Products	<a href="http://www.dlp.com">www.dlp.com</a>
DSP	<a href="http://dsp.ti.com">dsp.ti.com</a>
Clocks and Timers	<a href="http://www.ti.com/clocks">www.ti.com/clocks</a>
Interface	<a href="http://interface.ti.com">interface.ti.com</a>
Logic	<a href="http://logic.ti.com">logic.ti.com</a>
Power Mgmt	<a href="http://power.ti.com">power.ti.com</a>
Microcontrollers	<a href="http://microcontroller.ti.com">microcontroller.ti.com</a>
RFID	<a href="http://www.ti-rfid.com">www.ti-rfid.com</a>
OMAP Applications Processors	<a href="http://www.ti.com/omap">www.ti.com/omap</a>
Wireless Connectivity	<a href="http://www.ti.com/wirelessconnectivity">www.ti.com/wirelessconnectivity</a>

### Applications

Automotive and Transportation	<a href="http://www.ti.com/automotive">www.ti.com/automotive</a>
Communications and Telecom	<a href="http://www.ti.com/communications">www.ti.com/communications</a>
Computers and Peripherals	<a href="http://www.ti.com/computers">www.ti.com/computers</a>
Consumer Electronics	<a href="http://www.ti.com/consumer-apps">www.ti.com/consumer-apps</a>
Energy and Lighting	<a href="http://www.ti.com/energy">www.ti.com/energy</a>
Industrial	<a href="http://www.ti.com/industrial">www.ti.com/industrial</a>
Medical	<a href="http://www.ti.com/medical">www.ti.com/medical</a>
Security	<a href="http://www.ti.com/security">www.ti.com/security</a>
Space, Avionics and Defense	<a href="http://www.ti.com/space-avionics-defense">www.ti.com/space-avionics-defense</a>
Video and Imaging	<a href="http://www.ti.com/video">www.ti.com/video</a>

### TI E2E Community

[e2e.ti.com](http://e2e.ti.com)