

DS90C031QML LVDS Quad CMOS Differential Line Driver

 Check for Samples: [DS90C031QML](#)

FEATURES

- Radiation guaranteed 100 krad(Si)
- High impedance LVDS outputs with power-off
- ± 350 mV differential signaling
- Low power dissipation
- Low differential skew
- Low propagation delay
- Pin compatible with DS26C31
- Compatible with IEEE 1596.3 SCI LVDS standard
- Compatible with proposed TIA LVDS standard
- Fail safe logic for floating inputs

DESCRIPTION

The DS90C031 is a quad CMOS differential line driver designed for applications requiring ultra low power dissipation and high data rates.

The DS90C031 accepts TTL/CMOS input levels and translates them to low voltage (350 mV) differential output signals. In addition the driver supports a TRI-STATE function that may be used to disable the output stage, thus dropping the device to a low idle power state of 11 mW typical.

In addition, the DS90C031 provides power-off high impedance LVDS outputs. This feature assures minimal loading effect on the LVDS bus lines when V_{CC} is not present. The DS90C031 and companion line receiver (DS90C032) provide a new alternative to high power psuedo-ECL devices for high speed point-to-point interface applications.

Connection Diagram

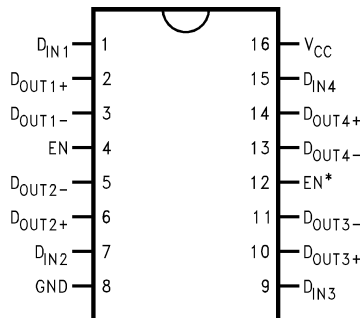

Figure 1. Dual-In-Line
See Package Number NAD0016A & NAC0016A

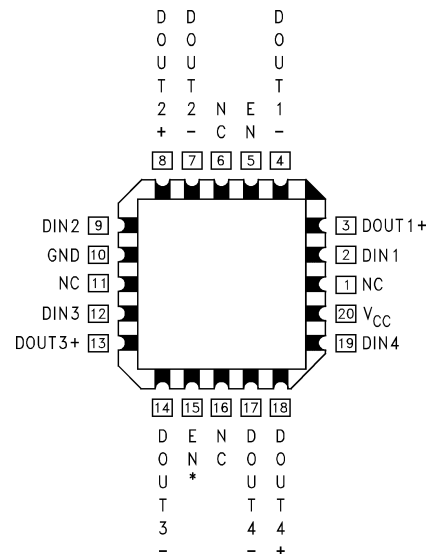

Figure 2. LCCC Package
See Package Number NAJ0020A



Please be aware that an important notice concerning availability, standard warranty, and use in critical applications of Texas Instruments semiconductor products and disclaimers thereto appears at the end of this data sheet.

All trademarks are the property of their respective owners.

Functional Block Diagram

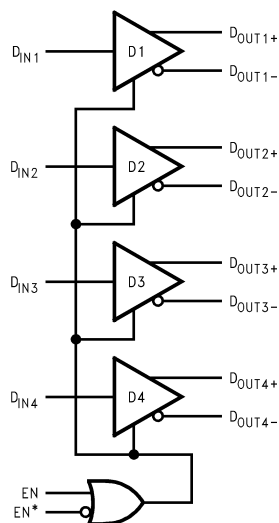

Truth Table

Enables		Input	Outputs	
EN	EN*	D _I	D _{O+}	D _{O-}
L	H	X	Z	Z
All other combinations of ENABLE inputs		L	L	H
		H	H	L



These devices have limited built-in ESD protection. The leads should be shorted together or the device placed in conductive foam during storage or handling to prevent electrostatic damage to the MOS gates.

Absolute Maximum Ratings⁽¹⁾

Supply Voltage (V_{CC})	-0.3V to +6V
Input Voltage (D_i)	-0.3V to ($V_{CC} + 0.3V$)
Enable Input Voltage (EN, EN*)	-0.3V to ($V_{CC} + 0.3V$)
Output Voltage (D_{O+} , D_{O-})	-0.3V to + 5.8V
Storage Temperature Range	$-65^{\circ}\text{C} \leq T_A \leq +150^{\circ}\text{C}$
Lead Temperature Range, Soldering (4 seconds)	+260°C
Maximum Package Power Dissipation at +25°C ⁽²⁾	
20 Pin LCCC Package	1900 mW
16 Pin CLGA (NAD)	1450 mW
16 Pin CLGA (NAC)	1450 mW
Thermal Resistance	
θ_{JA}	
20 Pin LCCC Package	78°C/W
16 Pin CLGA (NAD)	145°C/W
16 Pin CLGA (NAC)	145°C/W
θ_{JC}	
20 Pin LCCC Package	18°C/W
16 Pin CLGA (NAD)	14°C/W
16 Pin CLGA (NAC)	14°C/W
ESD Rating ⁽³⁾	3.5KV

(1) Absolute Maximum Ratings indicate limits beyond which damage to the device may occur. Operating Ratings indicate conditions for which the device is functional, but do not guarantee specific performance limits. For guaranteed specifications and test conditions, see the Electrical Characteristics. The guaranteed specifications apply only for the test conditions listed. Some performance characteristics may degrade when the device is not operated under the listed test conditions.

(2) Derate LCCC at 12.8mW/°C above +25°C. Derate CLGA at 6.9mW/°C above +25°C.

(3) Human body model, 1.5 k Ω in series with 100 pF.

Recommended Operating Conditions

	Min	Typ	Max	Unit
Supply Voltage (V_{CC})	+4.5	+5.0	+5.5	V
Operating Free Air Temperature (T_A)	-55	+25	+125	°C

Quality Conformance Inspection

Table 1. Mil-Std-883, Method 5005 - Group A

Subgroup	Description	Temp (°C)
1	Static tests at	+25
2	Static tests at	+125
3	Static tests at	-55
4	Dynamic tests at	+25
5	Dynamic tests at	+125
6	Dynamic tests at	-55
7	Functional tests at	+25
8A	Functional tests at	+125
8B	Functional tests at	-55
9	Switching tests at	+25
10	Switching tests at	+125
11	Switching tests at	-55
12	Settling time at	+25
13	Settling time at	+125
14	Settling time at	-55

DC Parameters ⁽¹⁾

Symbol	Parameter	Conditions	Notes	Min	Max	Units	Sub-groups
V _{OD1}	Differential Output Voltage	R _L = 100Ω		250	450	mV	1, 2, 3
DV _{OD1}	Change in Magnitude of Vod1 for complementary output States	R _L = 100Ω			35	mV	1, 2, 3
V _{OS}	Offset Voltage	R _L = 100Ω		1.12 5	1.37 5	V	1, 2, 3
DV _{OS}	Change in Magnitude of Vos for Complementary Output States	R _L = 100Ω			25	mV	1, 2, 3
V _{OH}	Output Voltage High	R _L = 100Ω			1.6	V	1, 2, 3
V _{OL}	Output Voltage Low	R _L = 100Ω		0.9		V	1, 2, 3
V _{IH}	Input Voltage High		(2)	2.0	V _{CC}	V	1, 2, 3
V _{IL}	Input Voltage Low		(2)	Gnd	0.8	V	1, 2, 3
I _I	Input Current	V _I = V _{CC} , Gnd, 2.5, or 0.4V			±10	μA	1, 2, 3
V _{CI}	Input Clamp Voltage	I _{CI} = -18mA			-1.5	V	1, 2, 3
I _{OS}	Output Short Circuit Current	V _O = 0V			-5.0	mA	1, 2, 3
I _{Off}	Power-off Leakage	V _O = 0V or 2.4V, V _{CC} = 0V or Open			±10	μA	1, 2, 3
I _{OZ}	Output TRI-STATE Current	EN = 0.8V and EN* = 2.0V V _O = 0V or V _{CC}			±10	μA	1, 2, 3
I _{CC}	Drivers Enabled Supply Current	D _I = Hi or Low			25	mA	1, 2, 3
I _{CCZ}	Drivers Disabled Supply Current	D _I = Hi or Low, En = Gnd, En* = V _{CC}			10	mA	1, 2, 3

(1) Pre and Post irradiation limits are identical to those listed under AC and DC electrical characteristics except as listed in the "Post Radiation Limits" table. Radiation end point limits for the noted parameters are guaranteed only for the conditions, as specified.

(2) Tested during V_{OH} / V_{OL} tests.

AC Parameters

The following conditions apply, unless otherwise specified.

AC: $V_{CC} = 4.5V / 5.0V / 5.5V$, $R_L = 100\Omega$ (between outputs), $C_L = 20pF$ (each output to Gnd)

Symbol	Parameter	Conditions	Notes	Min	Max	Units	Sub-groups
t_{PHLD}	Differential Propagation Delay High to Low			0.5	5.0	ns	9, 10, 11
t_{PLHD}	Differential Propagation Delay Low to High			0.5	5.0	ns	9, 10, 11
t_{SKD}	Differential Skew $ t_{PHLD} - t_{PLHD} $				3.0	ns	9, 10, 11
t_{SK1}	Channel to Channel Skew		(1)		3.0	ns	9, 10, 11
t_{SK2}	Chip to Chip Skew		(2)		4.5	ns	9, 10, 11
t_{PHZ}	Disable Time High to Z		(3)		20	ns	9, 10, 11
t_{PLZ}	Disable Time Low To Z		(3)		20	ns	9, 10, 11
t_{PZH}	Enable Time Z to High		(3)		20	ns	9, 10, 11
t_{PZL}	Enable Time Z to Low		(3)		20	ns	9, 10, 11

- (1) Channel-to-Channel Skew is defined as the difference between the propagation delay of the channel and the other channels in the same chip with an event on the inputs.
 (2) Chip to Chip Skew is defined as the difference between the minimum and maximum specified differential propagation delays.
 (3) Parameter guaranteed, not tested 100%

AC/DC Parameters - Post Radiation Limits ⁽¹⁾

Symbol	Parameter	Conditions	Notes	Min	Max	Units	Sub-groups
I_{CC}	Drivers Enabled Supply Current	$D_I - Hi$ or Low, $En = Gnd$, $En^* = V_{CC}$			30	mA	1
I_{CCZ}	Drivers Disabled Supply Current	$D_I - Hi$ or Low, $En = Gnd$, $En^* = V_{CC}$			30	mA	1

- (1) Pre and Post irradiation limits are identical to those listed under AC and DC electrical characteristics except as listed in the "Post Radiation Limits" table. Radiation end point limits for the noted parameters are guaranteed only for the conditions, as specified.

Parameter Measurement Information

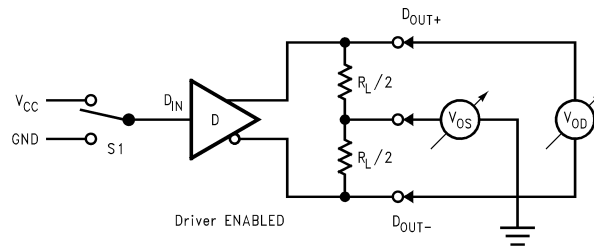

Figure 3. Driver V_{OD} and V_{OS} Test Circuit

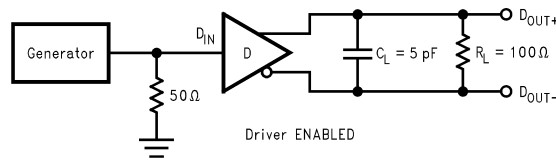

Figure 4. Driver Propagation Delay and Transition Time Test Circuit

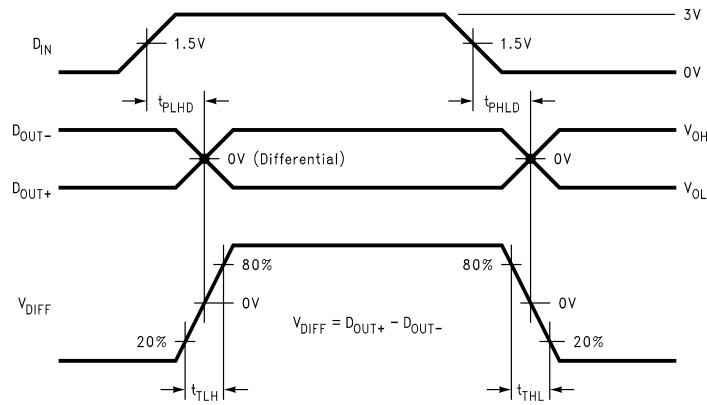

Figure 5. Driver Propagation Delay and Transition Time Waveforms

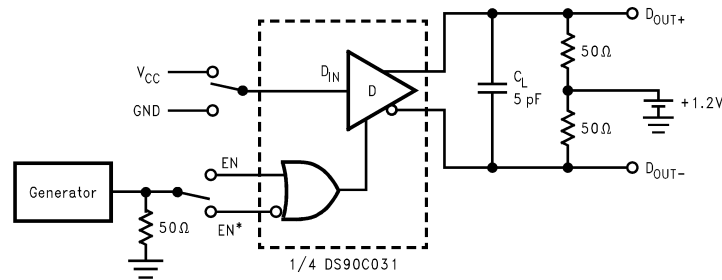

Figure 6. Driver TRI-STATE Delay Test Circuit

Parameter Measurement Information (continued)

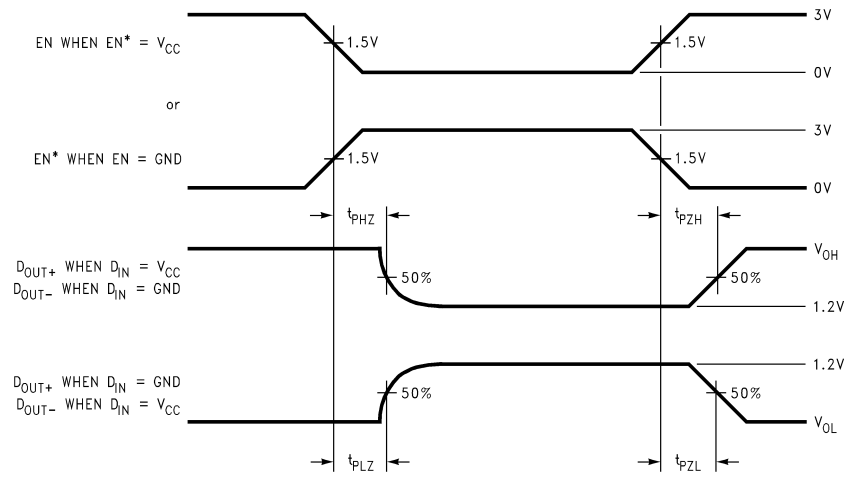

Figure 7. Driver TRI-STATE Delay Waveform

Typical Performance Characteristics

Power Supply Current vs Power Supply Voltage

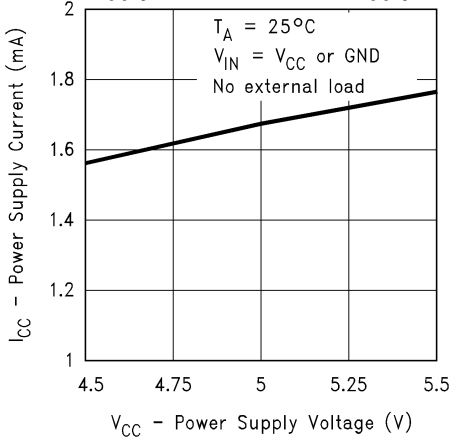

Figure 8.

Power Supply Current vs Temperature

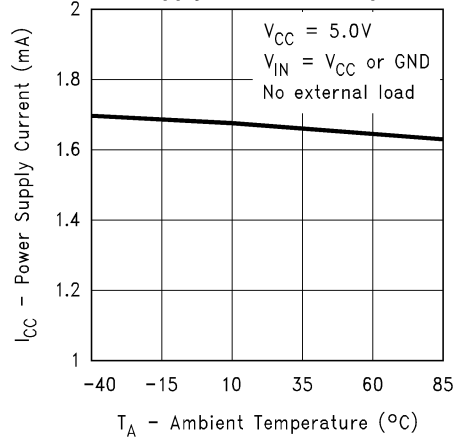

Figure 9.

Power Supply Current vs Power Supply Voltage

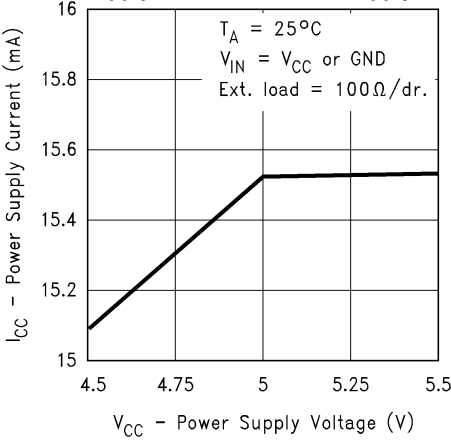

Figure 10.

Power Supply Current vs Temperature

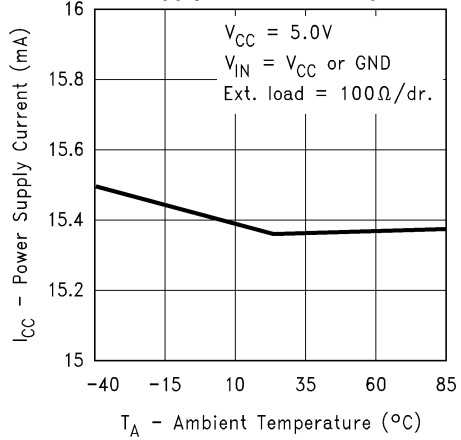

Figure 11.

Output TRI-STATE Current vs Power Supply Voltage

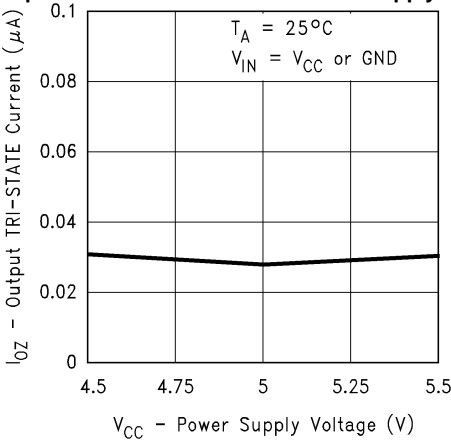

Figure 12.

Output Short Circuit Current vs Power Supply Voltage

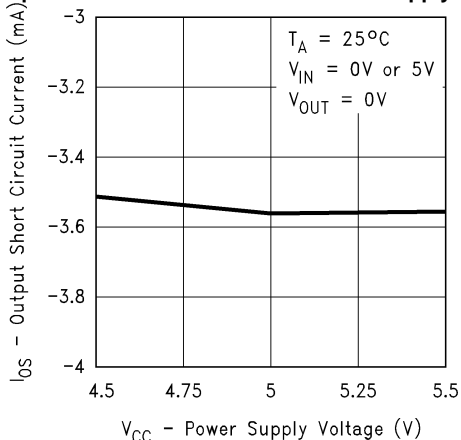

Figure 13.

Typical Performance Characteristics (continued)

Differential Output Voltage vs Power Supply Voltage

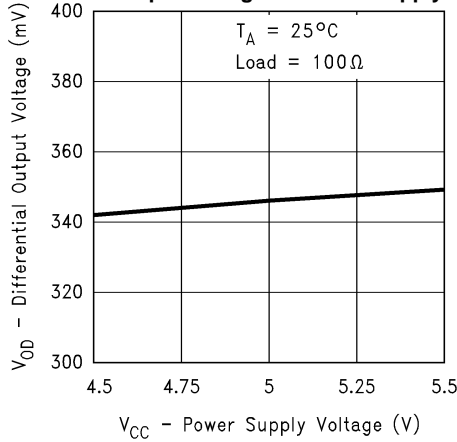

Figure 14.

Differential Output Voltage vs Ambient Temperature

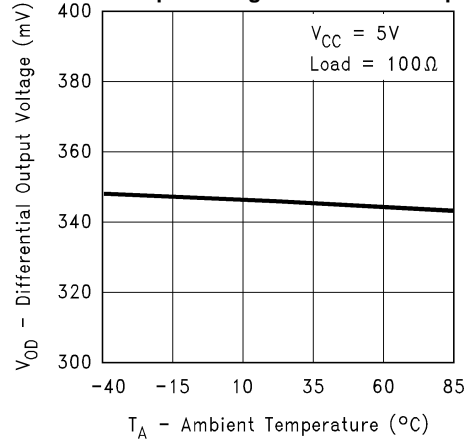

Figure 15.

Output Voltage High vs Power Supply Voltage

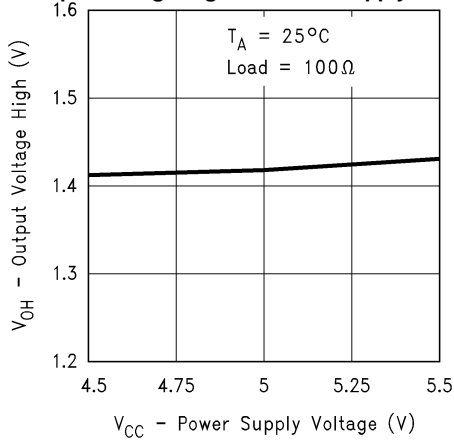

Figure 16.

Output Voltage High vs Ambient Temperature

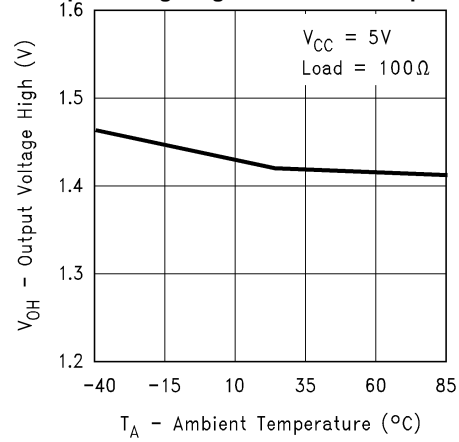

Figure 17.

Output Voltage Low vs Power Supply Voltage

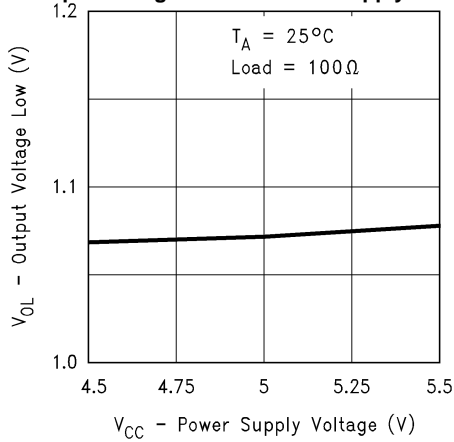

Figure 18.

Output Voltage Low vs Ambient Temperature

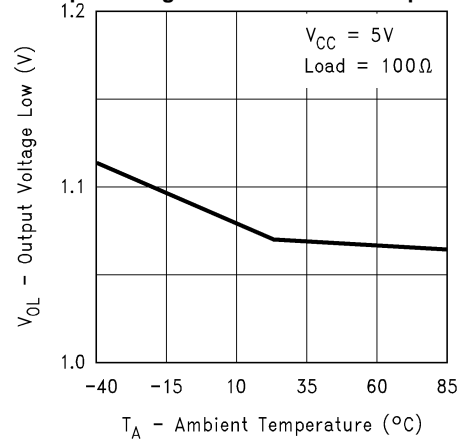

Figure 19.

Typical Performance Characteristics (continued)

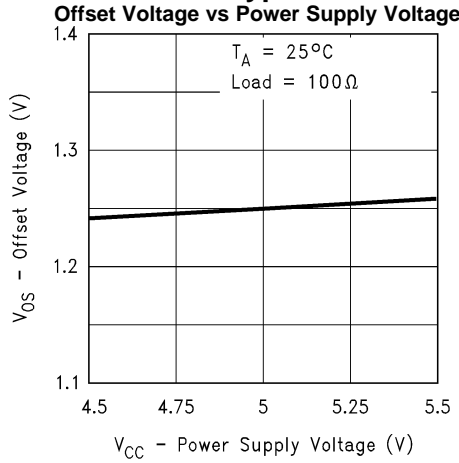

Figure 20.

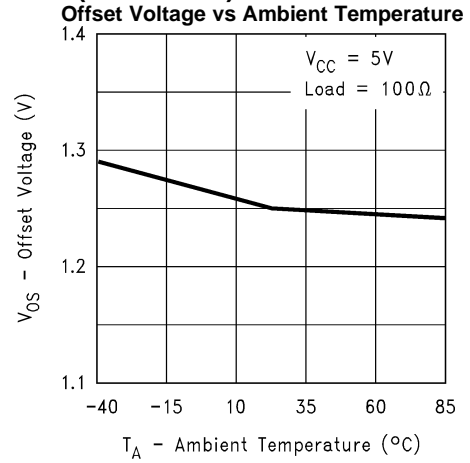

Figure 21.

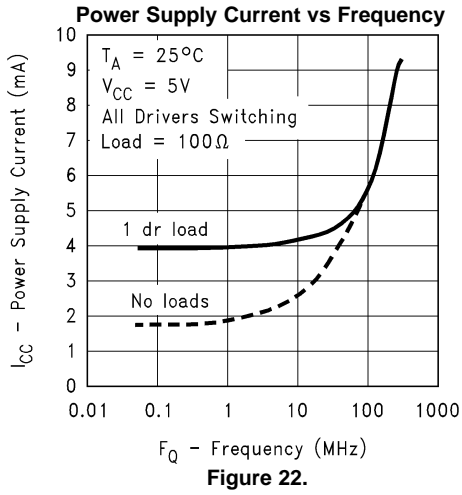

Figure 22.

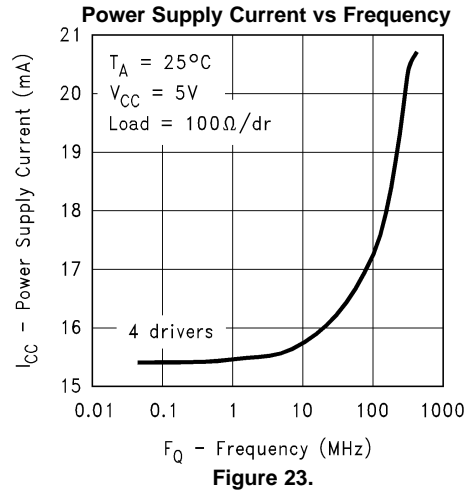

Figure 23.

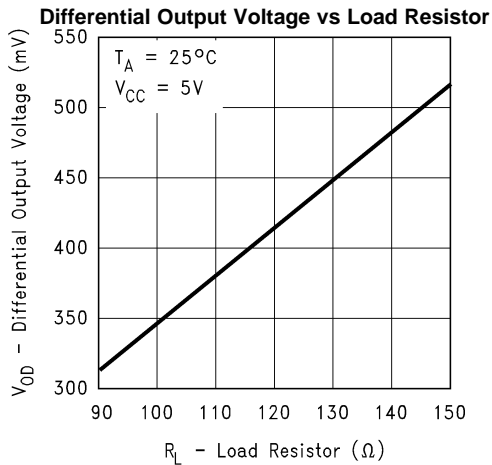

Figure 24.

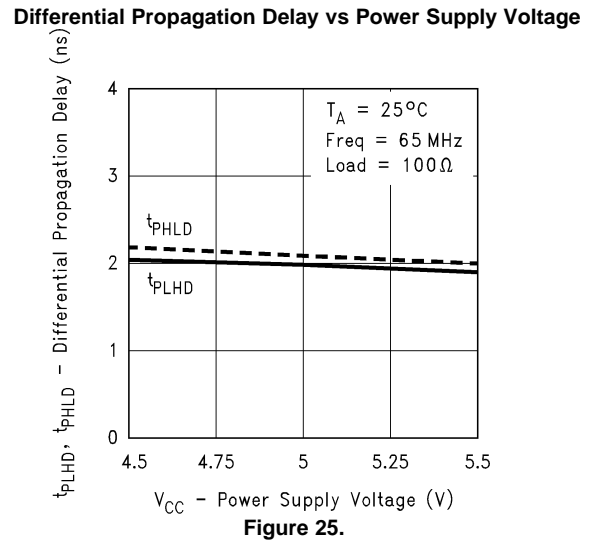

Figure 25.

Typical Performance Characteristics (continued)

Differential Propagation Delay vs Ambient Temperature

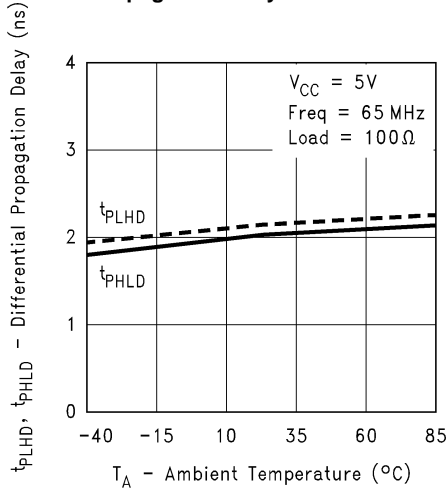

Figure 26.

Differential Skew vs Power Supply Voltage

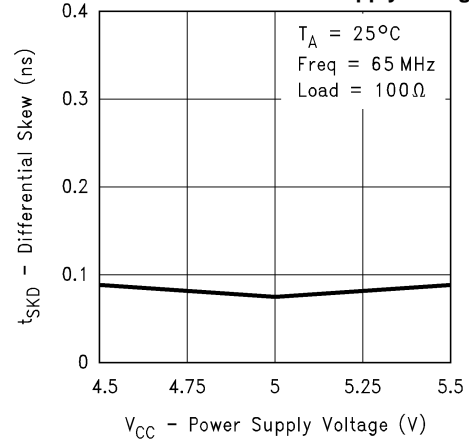

Figure 27.

Differential Skew vs Ambient Temperature

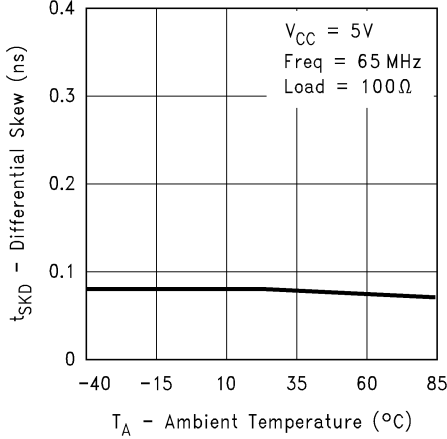

Figure 28.

Differential Transition Time vs Power Supply Voltage

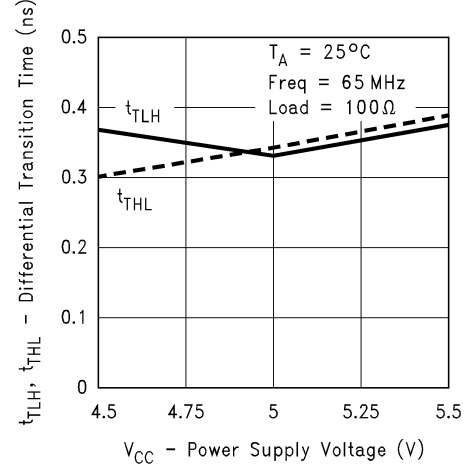

Figure 29.

Differential Transition Time vs Ambient Temperature

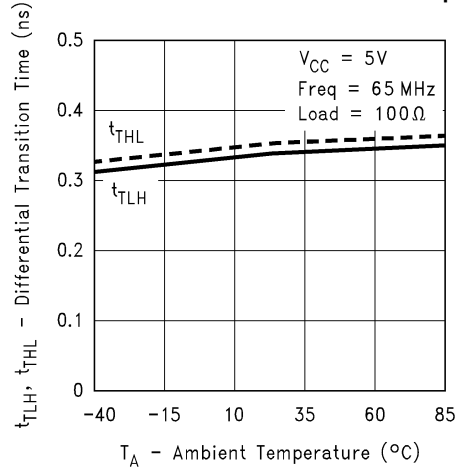

Figure 30.

TYPICAL APPLICATION

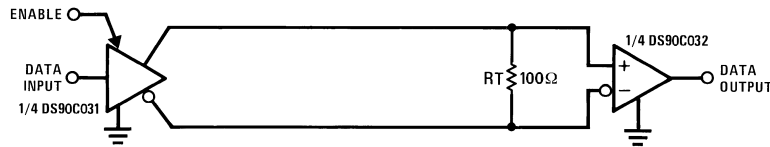

Figure 31. Point-to-Point Application

APPLICATIONS INFORMATION

LVDS drivers and receivers are intended to be primarily used in an uncomplicated point-to-point configuration as is shown in [Figure 31](#). This configuration provides a clean signaling environment for the quick edge rates of the drivers. The receiver is connected to the driver through a balanced media which may be a standard twisted pair cable, a parallel pair cable, or simply PCB traces. Typically, the characteristic impedance of the media is in the range of 100Ω. A termination resistor of 100Ω should be selected to match the media, and is located as close to the receiver input pins as possible. The termination resistor converts the current sourced by the driver into a voltage that is detected by the receiver. Other configurations are possible such as a multi-receiver configuration, but the effects of a mid-stream connector(s), cable stub(s), and other impedance discontinuities as well as ground shifting, noise margin limits, and total termination loading must be taken into account.

The DS90C031 differential line driver is a balanced current source design. A current mode driver, generally speaking has a high output impedance and supplies a constant current for a range of loads (a voltage mode driver on the other hand supplies a constant voltage for a range of loads). Current is switched through the load in one direction to produce a logic state and in the other direction to produce the other logic state. The typical output current is mere 3.4 mA, a minimum of 2.5 mA, and a maximum of 4.5 mA. The current mode **requires** (as discussed above) that a resistive termination be employed to terminate the signal and to complete the loop as shown in [Figure 31](#). AC or unterminated configurations are not allowed. The 3.4 mA loop current will develop a differential voltage of 340 mV across the 100Ω termination resistor which the receiver detects with a 240 mV minimum differential noise margin neglecting resistive line losses (driven signal minus receiver threshold (340 mV – 100 mV = 240 mV)). The signal is centered around +1.2V (Driver Offset, V_{OS}) with respect to ground as shown in [Figure 32](#). Note that the steady-state voltage (V_{SS}) peak-to-peak swing is twice the differential voltage (V_{OD}) and is typically 680 mV.

The current mode driver provides substantial benefits over voltage mode drivers, such as an RS-422 driver. Its quiescent current remains relatively flat versus switching frequency. Whereas the RS-422 voltage mode driver increases exponentially in most case between 20 MHz–50 MHz. This is due to the overlap current that flows between the rails of the device when the internal gates switch. Whereas the current mode driver switches a fixed current between its output without any substantial overlap current. This is similar to some ECL and PECL devices, but without the heavy static I_{CC} requirements of the ECL/PECL designs. LVDS requires > 80% less current than similar PECL devices. AC specifications for the driver are a tenfold improvement over other existing RS-422 drivers.

The TRI-STATE function allows the driver outputs to be disabled, thus obtaining an even lower power state when the transmission of data is not required. The LVDS outputs are high impedance under power-off condition. This allows for multiple or redundant drivers to be used in certain applications.

The footprint of the DS90C031 is the same as the industry standard 26LS31 Quad Differential (RS-422) Driver.

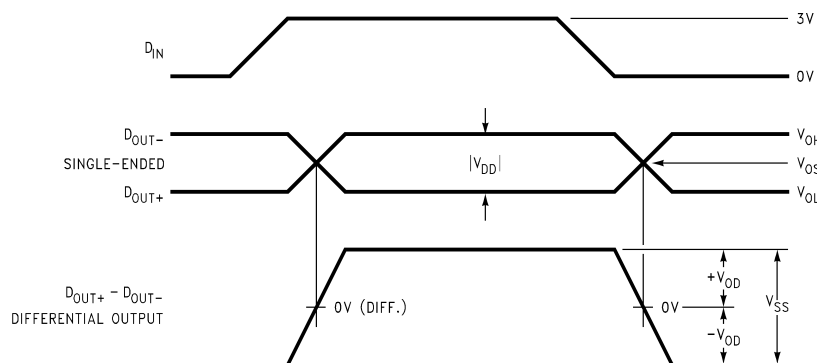
Figure 32. Driver Output Levels

Pin Descriptions

Pin No. (SOIC)	Name	Description
1, 7, 9, 15	D _I	Driver input pin, TTL/CMOS compatible
2, 6, 10, 14	D _{O+}	Non-inverting driver output pin, LVDS levels
3, 5, 11, 13	D _{O-}	Inverting driver output pin, LVDS levels
4	EN	Active high enable pin, OR-ed with EN*
12	EN*	Active low enable pin, OR-ed with EN
16	V _{CC}	Power supply pin, +5V ± 10%
8	Gnd	Ground pin

Radiation Environments

Careful consideration should be given to environmental conditions when using a product in a radiation environment.

Total Ionizing Dose

Radiation hardness assured (RHA) products are those part numbers with a total ionizing dose (TID) level specified in the Ordering Information table on the front page. Testing and qualification of these products is done on a wafer level according to MIL-STD-883G, Test Method 1019.7, Condition A and the "Extended room temperature anneal test" described in section 3.11 for application environment dose rates less than 0.16 rad(Si)/s. Wafer level TID data is available with lot shipments.

Single Event Latch-Up

One time single event latch-up (SEL) testing was performed showing SEL immunity to 103 MeV-cm²/mg. A test report is available upon request.

Single Event Upset

Single event upset (SEU) data are available upon request.

REVISION HISTORY

Released	Revision	Section	Changes
03/01/06	New	New Release, Corporate format	1 MDS data sheet converted into Corp. data sheet format. MNDS90C031-X-RH Rev 2A1 will be archived.
10/12/2010	A	Features, Ordering Table, Absolute Maximum Ratings, Applications Information	Added reference to Radiation and Fail safe. Removed reference to EOL NSID, Output Voltage changed limit from -0.3V to (V _{CC} + 0.3V) to -0.3V to +5.8V, Added paragraph to Applications Information section and New Radiation Environment section. Revision A will be Archived.
03/04/2013	B	All	Changed layout of National Data Sheet to TI format.

PACKAGING INFORMATION

Orderable Device	Status (1)	Package Type	Package Drawing	Pins	Package Qty	Eco Plan (2)	Lead/Ball Finish	MSL Peak Temp (3)	Op Temp (°C)	Top-Side Markings (4)	Samples
5962-9583301Q2A	ACTIVE	LCCC	NAJ	20	50	TBD	Call TI	Call TI	-55 to 125	DS90C031E -QML Q 5962-95833 01Q2A ACO 01Q2A >T	Samples
5962-9583301VFA	ACTIVE	CFP	NAD	16	19	TBD	Call TI	Call TI	-55 to 125	DS90C031W- QMLV Q 5962-95833 01VFA ACO 01VFA >T	Samples
5962R9583301VFA	ACTIVE	CFP	NAD	16	19	TBD	Call TI	Call TI	-55 to 125	DS90C031WR QMLV Q 5962R95833 01VFA ACO 01VFA >T	Samples
5962R9583301VZA	ACTIVE	CFP	NAC	16	42	TBD	Call TI	Call TI	-55 to 125	DS90C031WGR QMLV Q 5962R95833 01VZA ACO 01VZA >T	Samples
DS90C031E-QML	ACTIVE	LCCC	NAJ	20	50	TBD	Call TI	Call TI	-55 to 125	DS90C031E -QML Q 5962-95833 01Q2A ACO 01Q2A >T	Samples
DS90C031W-QMLV	ACTIVE	CFP	NAD	16	19	TBD	Call TI	Call TI	-55 to 125	DS90C031W- QMLV Q 5962-95833 01VFA ACO 01VFA >T	Samples
DS90C031WGRQMLV	ACTIVE	CFP	NAC	16	42	TBD	Call TI	Call TI	-55 to 125	DS90C031WGR QMLV Q 5962R95833 01VZA ACO 01VZA >T	Samples
DS90C031WRQMLV	ACTIVE	CFP	NAD	16	19	TBD	Call TI	Call TI	-55 to 125	DS90C031WR QMLV Q 5962R95833	Samples

Orderable Device	Status (1)	Package Type	Package Drawing	Pins	Package Qty	Eco Plan (2)	Lead/Ball Finish	MSL Peak Temp (3)	Op Temp (°C)	Top-Side Markings (4)	Samples
										01VFA ACO 01VFA >T	

(1) The marketing status values are defined as follows:

ACTIVE: Product device recommended for new designs.

LIFEBUY: TI has announced that the device will be discontinued, and a lifetime-buy period is in effect.

NRND: Not recommended for new designs. Device is in production to support existing customers, but TI does not recommend using this part in a new design.

PREVIEW: Device has been announced but is not in production. Samples may or may not be available.

OBSOLETE: TI has discontinued the production of the device.

(2) Eco Plan - The planned eco-friendly classification: Pb-Free (RoHS), Pb-Free (RoHS Exempt), or Green (RoHS & no Sb/Br) - please check <http://www.ti.com/productcontent> for the latest availability information and additional product content details.

TBD: The Pb-Free/Green conversion plan has not been defined.

Pb-Free (RoHS): TI's terms "Lead-Free" or "Pb-Free" mean semiconductor products that are compatible with the current RoHS requirements for all 6 substances, including the requirement that lead not exceed 0.1% by weight in homogeneous materials. Where designed to be soldered at high temperatures, TI Pb-Free products are suitable for use in specified lead-free processes.

Pb-Free (RoHS Exempt): This component has a RoHS exemption for either 1) lead-based flip-chip solder bumps used between the die and package, or 2) lead-based die adhesive used between the die and leadframe. The component is otherwise considered Pb-Free (RoHS compatible) as defined above.

Green (RoHS & no Sb/Br): TI defines "Green" to mean Pb-Free (RoHS compatible), and free of Bromine (Br) and Antimony (Sb) based flame retardants (Br or Sb do not exceed 0.1% by weight in homogeneous material)

(3) MSL, Peak Temp. -- The Moisture Sensitivity Level rating according to the JEDEC industry standard classifications, and peak solder temperature.

(4) Multiple Top-Side Markings will be inside parentheses. Only one Top-Side Marking contained in parentheses and separated by a "~" will appear on a device. If a line is indented then it is a continuation of the previous line and the two combined represent the entire Top-Side Marking for that device.

Important Information and Disclaimer: The information provided on this page represents TI's knowledge and belief as of the date that it is provided. TI bases its knowledge and belief on information provided by third parties, and makes no representation or warranty as to the accuracy of such information. Efforts are underway to better integrate information from third parties. TI has taken and continues to take reasonable steps to provide representative and accurate information but may not have conducted destructive testing or chemical analysis on incoming materials and chemicals. TI and TI suppliers consider certain information to be proprietary, and thus CAS numbers and other limited information may not be available for release.

In no event shall TI's liability arising out of such information exceed the total purchase price of the TI part(s) at issue in this document sold by TI to Customer on an annual basis.

OTHER QUALIFIED VERSIONS OF DS90C031QML, DS90C031QML-SP :

● Military: [DS90C031QML](#)

● Space: [DS90C031QML-SP](#)

NOTE: Qualified Version Definitions:

- Military - QML certified for Military and Defense Applications
- Space - Radiation tolerant, ceramic packaging and qualified for use in Space-based application

NAD0016A

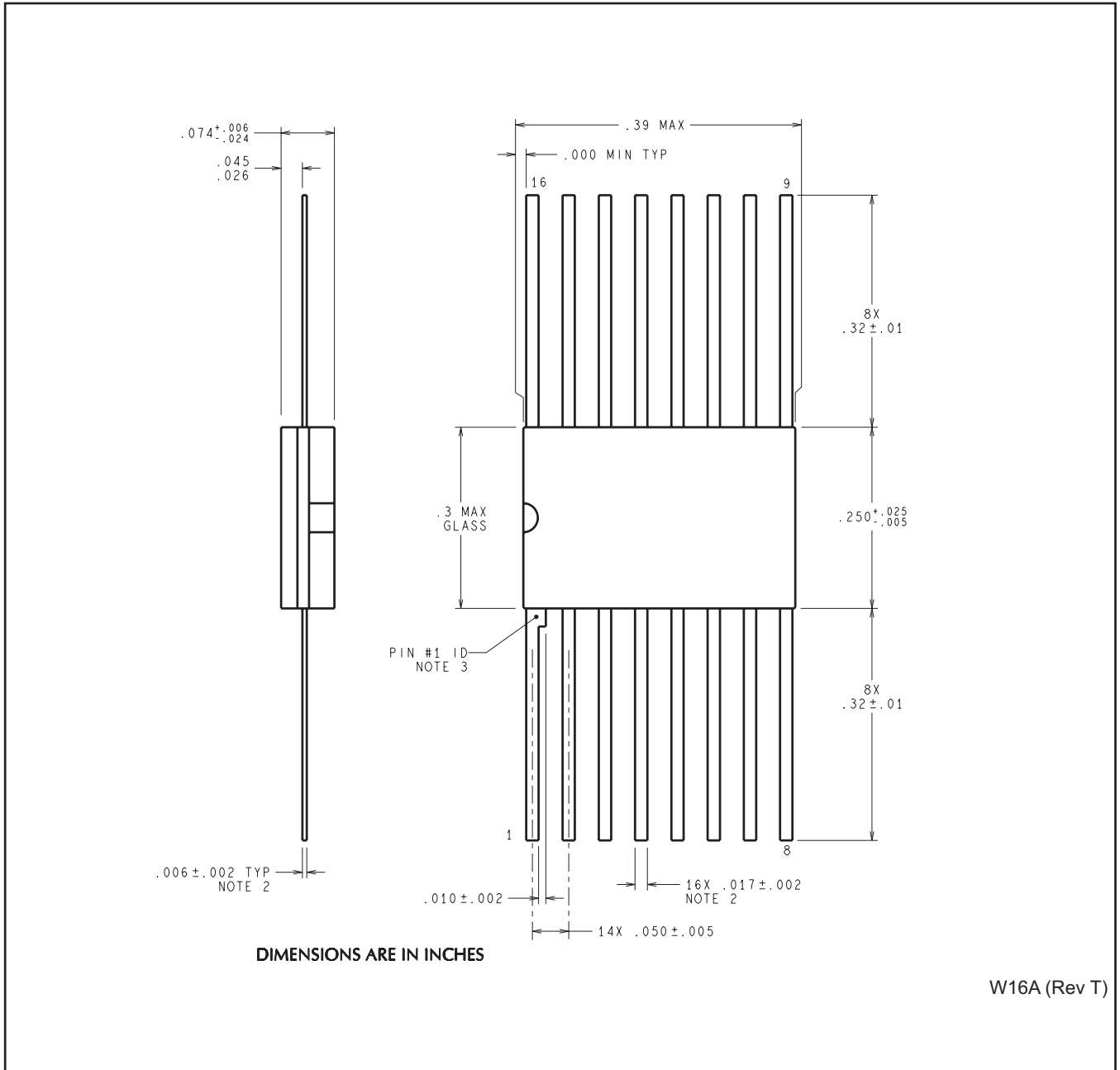

NAC0016A

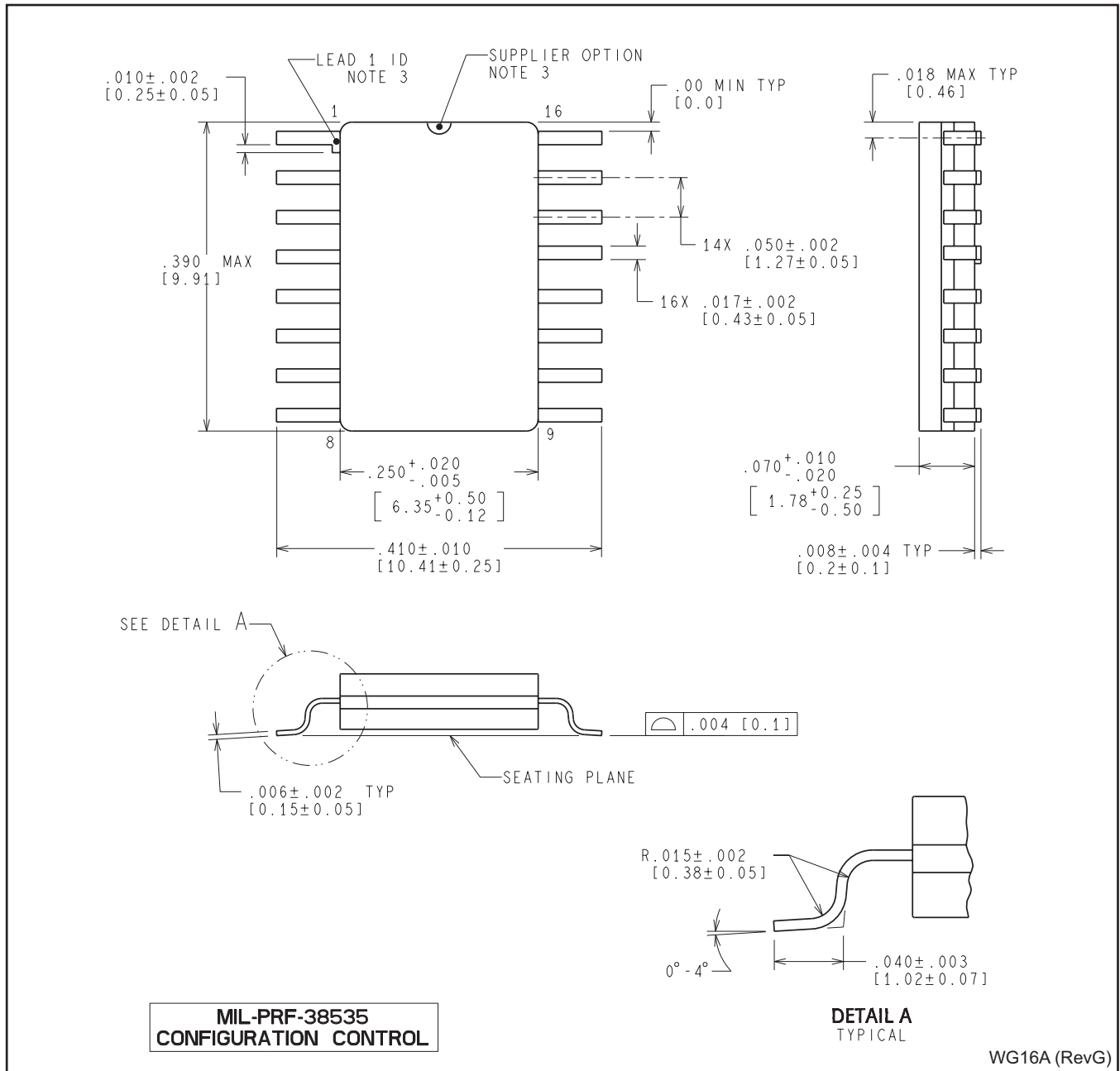

IMPORTANT NOTICE

Texas Instruments Incorporated and its subsidiaries (TI) reserve the right to make corrections, enhancements, improvements and other changes to its semiconductor products and services per JESD46, latest issue, and to discontinue any product or service per JESD48, latest issue. Buyers should obtain the latest relevant information before placing orders and should verify that such information is current and complete. All semiconductor products (also referred to herein as "components") are sold subject to TI's terms and conditions of sale supplied at the time of order acknowledgment.

TI warrants performance of its components to the specifications applicable at the time of sale, in accordance with the warranty in TI's terms and conditions of sale of semiconductor products. Testing and other quality control techniques are used to the extent TI deems necessary to support this warranty. Except where mandated by applicable law, testing of all parameters of each component is not necessarily performed.

TI assumes no liability for applications assistance or the design of Buyers' products. Buyers are responsible for their products and applications using TI components. To minimize the risks associated with Buyers' products and applications, Buyers should provide adequate design and operating safeguards.

TI does not warrant or represent that any license, either express or implied, is granted under any patent right, copyright, mask work right, or other intellectual property right relating to any combination, machine, or process in which TI components or services are used. Information published by TI regarding third-party products or services does not constitute a license to use such products or services or a warranty or endorsement thereof. Use of such information may require a license from a third party under the patents or other intellectual property of the third party, or a license from TI under the patents or other intellectual property of TI.

Reproduction of significant portions of TI information in TI data books or data sheets is permissible only if reproduction is without alteration and is accompanied by all associated warranties, conditions, limitations, and notices. TI is not responsible or liable for such altered documentation. Information of third parties may be subject to additional restrictions.

Resale of TI components or services with statements different from or beyond the parameters stated by TI for that component or service voids all express and any implied warranties for the associated TI component or service and is an unfair and deceptive business practice. TI is not responsible or liable for any such statements.

Buyer acknowledges and agrees that it is solely responsible for compliance with all legal, regulatory and safety-related requirements concerning its products, and any use of TI components in its applications, notwithstanding any applications-related information or support that may be provided by TI. Buyer represents and agrees that it has all the necessary expertise to create and implement safeguards which anticipate dangerous consequences of failures, monitor failures and their consequences, lessen the likelihood of failures that might cause harm and take appropriate remedial actions. Buyer will fully indemnify TI and its representatives against any damages arising out of the use of any TI components in safety-critical applications.

In some cases, TI components may be promoted specifically to facilitate safety-related applications. With such components, TI's goal is to help enable customers to design and create their own end-product solutions that meet applicable functional safety standards and requirements. Nonetheless, such components are subject to these terms.

No TI components are authorized for use in FDA Class III (or similar life-critical medical equipment) unless authorized officers of the parties have executed a special agreement specifically governing such use.

Only those TI components which TI has specifically designated as military grade or "enhanced plastic" are designed and intended for use in military/aerospace applications or environments. Buyer acknowledges and agrees that any military or aerospace use of TI components which have **not** been so designated is solely at the Buyer's risk, and that Buyer is solely responsible for compliance with all legal and regulatory requirements in connection with such use.

TI has specifically designated certain components as meeting ISO/TS16949 requirements, mainly for automotive use. In any case of use of non-designated products, TI will not be responsible for any failure to meet ISO/TS16949.

Products

Audio	www.ti.com/audio
Amplifiers	amplifier.ti.com
Data Converters	dataconverter.ti.com
DLP® Products	www.dlp.com
DSP	dsp.ti.com
Clocks and Timers	www.ti.com/clocks
Interface	interface.ti.com
Logic	logic.ti.com
Power Mgmt	power.ti.com
Microcontrollers	microcontroller.ti.com
RFID	www.ti-rfid.com
OMAP Applications Processors	www.ti.com/omap
Wireless Connectivity	www.ti.com/wirelessconnectivity

Applications

Automotive and Transportation	www.ti.com/automotive
Communications and Telecom	www.ti.com/communications
Computers and Peripherals	www.ti.com/computers
Consumer Electronics	www.ti.com/consumer-apps
Energy and Lighting	www.ti.com/energy
Industrial	www.ti.com/industrial
Medical	www.ti.com/medical
Security	www.ti.com/security
Space, Avionics and Defense	www.ti.com/space-avionics-defense
Video and Imaging	www.ti.com/video

TI E2E Community

e2e.ti.com