

# DS25BR440 3.125 Gbps Quad LVDS Buffer with Transmit Pre-Emphasis and Receive Equalization

Check for Samples: [DS25BR440](#)

## FEATURES

- DC - 3.125 Gbps Low Jitter, Low Skew, Low Power Operation
- Pin Selectable Transmit Pre-Emphasis and Receive Equalization Eliminate Data Dependant Jitter
- Wide Input Common Mode Voltage Range Allows DC-Coupled Interface to LVDS, CML and LVPECL Drivers
- $\overline{\text{LOS}}$  Circuitry Detects Open Inputs Fault
- Integrated 100 $\Omega$  Input and Output Terminations
- 8 kV ESD on LVDS I/O Pins Protects Adjoining Components
- Small 6 mm x 6 mm WQFN-40 Space Saving Package

## APPLICATIONS

- Clock and Data Buffering and Repeating
- Copper Cable Driving and Equalization
- FR-4 Equalization
- OC-48 / STM-16

## Typical Application

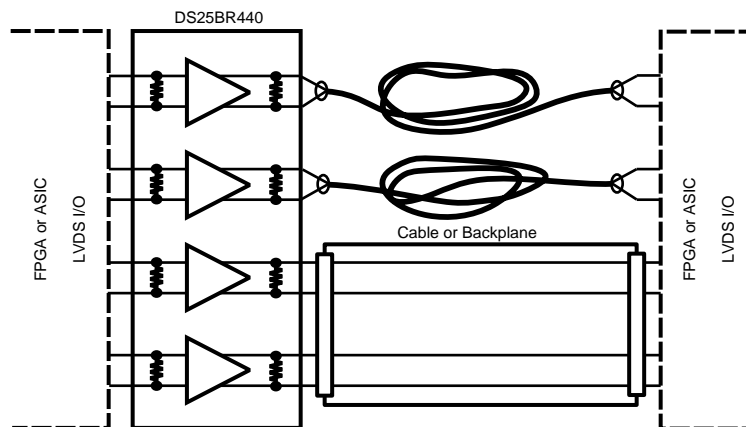

## DESCRIPTION

The DS25BR440 is a 3.125 Gbps Quad LVDS buffer optimized for high-speed signal routing and repeating over lossy FR-4 printed circuit board backplanes and balanced cables. Fully differential signal paths ensure exceptional signal integrity and noise immunity.

The DS25BR440 features two levels of transmit pre-emphasis (PE) and two levels of receive equalization (EQ). Both of these features compensate for interconnect losses and ultimately maximize noise margin. A loss-of-signal ( $\overline{\text{LOS}}$ ) circuit monitors each input channel and a unique  $\overline{\text{LOS}}$  pin is asserted when no signal is detected at that input.

Wide input common mode range allows the switch to accept signals with LVDS, CML and LVPECL levels; the output levels are LVDS. A very small package footprint requires a minimal space on the board while the flow-through pinout allows easy board layout. Each differential input and output is internally terminated with a 100 $\Omega$  resistor to lower device return losses, reduce component count and further minimize board space.



Please be aware that an important notice concerning availability, standard warranty, and use in critical applications of Texas Instruments semiconductor products and disclaimers thereto appears at the end of this data sheet.

All trademarks are the property of their respective owners.

**Block Diagram**

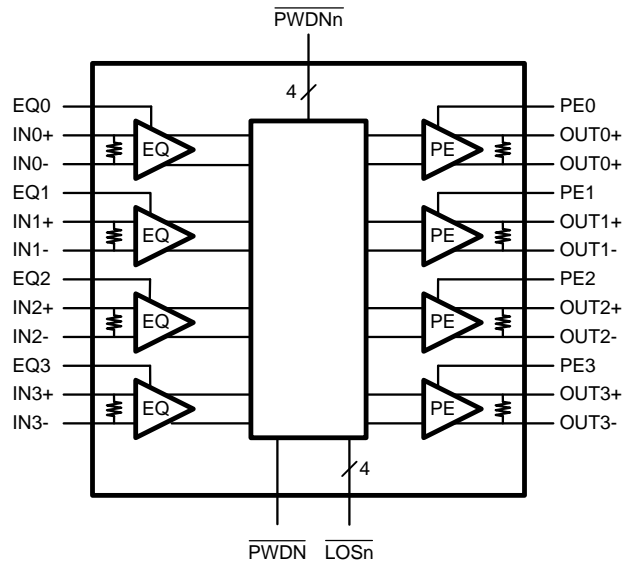

**Connection Diagram**

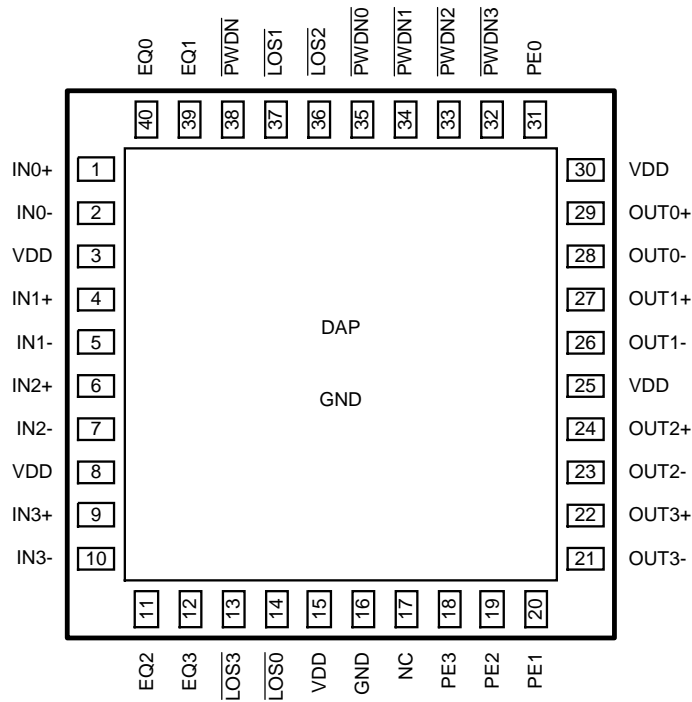

**DS25BR440 Pin Diagram**

**PIN DESCRIPTIONS**

| Pin Name   | Pin Number                              | I/O, Type | Pin Description  |
|--|---|-----------|--|
| IN0+, IN0-,<br>IN1+, IN1-,<br>IN2+, IN2-,<br>IN3+, IN3-  | 1, 2,<br>4, 5,<br>6, 7,<br>9, 10        | I, LVDS   | Inverting and non-inverting high speed LVDS input pins.  |
| OUT0+, OUT0-,<br>OUT1+, OUT1-,<br>OUT2+, OUT2-,<br>OUT3+, OUT3-  | 29, 28,<br>27, 26,<br>24, 23,<br>22, 21 | O, LVDS   | Inverting and non-inverting high speed LVDS output pins.   |
| EQ0, EQ1,<br>EQ2, EQ3  | 40, 39,<br>11, 12                       | I, LVCMOS | Receive equalization level select pins.  |
| PE0, PE1,<br>PE2, PE3  | 31, 20,<br>19, 18                       | I, LVCMOS | Transmit pre-emphasis level select pins.   |
| $\overline{\text{PWDN0}}$ ,<br>$\overline{\text{PWDN1}}$ ,<br>$\overline{\text{PWDN2}}$ ,<br>$\overline{\text{PWDN3}}$ | 35,<br>34,<br>33,<br>32                 | I, LVCMOS | Channel output power down pins. When the $\overline{\text{PWDNn}}$ is set to L, the channel output OUTn is in the power down mode. The $\overline{\text{LOS}}$ circuitry on the corresponding input remains enabled. |
| $\overline{\text{LOS0}}$ , $\overline{\text{LOS1}}$ ,<br>$\overline{\text{LOS2}}$ , $\overline{\text{LOS3}}$           | 14, 37,<br>36, 13                       | O, LVCMOS | Loss Of Signal output pins, $\overline{\text{LOSn}}$ report when an open input fault condition is detected at the input, INn. These are open drain outputs. External pull up resistors are required.                 |
| NC   | 17                                      | NC        | NO CONNECT pins. May be left floating.   |
| $\overline{\text{PWDN}}$   | 38                                      | I, LVCMOS | Device power down pin. When the $\overline{\text{PWDN}}$ is set to L, the device is in the power down mode. The $\overline{\text{LOS}}$ circuitry is disabled as well.   |
| VDD  | 3, 8,<br>15, 25, 30                     | Power     | Power supply pins.   |
| GND  | 16, DAP                                 | Power     | Ground pin and a pad (DAP - die attach pad).   |



These devices have limited built-in ESD protection. The leads should be shorted together or the device placed in conductive foam during storage or handling to prevent electrostatic damage to the MOS gates.

**Absolute Maximum Ratings**<sup>(1)(2)</sup>

|  |                              |
|--|------------------------------|
| Supply Voltage                               | -0.3V to +4V                 |
| LVC MOS Input Voltage                        | -0.3V to ( $V_{CC} + 0.3V$ ) |
| LVC MOS Output Voltage                       | -0.3V to ( $V_{CC} + 0.3V$ ) |
| LVDS Input Voltage                           | -0.3V to +4V                 |
| Differential Input Voltage  VID              | 1V                           |
| LVDS Output Voltage                          | -0.3V to ( $V_{CC} + 0.3V$ ) |
| LVDS Differential Output Voltage             | 0.0V to +1V                  |
| LVDS Output Short Circuit Current Duration   | 5 ms                         |
| Junction Temperature                         | +150°C                       |
| Storage Temperature Range                    | -65°C to +150°C              |
| Lead Temperature Range<br>Soldering (4 sec.) | +260°C                       |
| Maximum Package Power Dissipation at 25°C    |                              |
| RTA0040A Package                             | 2.44W                        |
| Derate RTA0040A Package                      | 19.49 mW/°C above +25°C      |
| Package Thermal Resistance                   |                              |
| $\theta_{JA}$                                | +26.9°C/W                    |
| $\theta_{JC}$                                | +3.8°C/W                     |
| ESD Susceptibility                           |                              |
| HBM <sup>(3)</sup>                           | ≥8 kV                        |
| MM <sup>(4)</sup>                            | ≥250V                        |
| CDM <sup>(5)</sup>                           | ≥1250V                       |

- (1) "Absolute Maximum Ratings" indicate limits beyond which damage to the device may occur, including inoperability and degradation of device reliability and/or performance. Functional operation of the device and/or non-degradation at the Absolute Maximum Ratings or other conditions beyond those indicated in the Recommended Operating Conditions is not implied. The Recommended Operating Conditions indicate conditions at which the device is functional and the device should not be operated beyond such conditions.
- (2) If Military/Aerospace specified devices are required, please contact the TI Sales Office/Distributors for availability and specifications.
- (3) Human Body Model, applicable std. JESD22-A114C
- (4) Machine Model, applicable std. JESD22-A115-A
- (5) Field Induced Charge Device Model, applicable std. JESD22-C101-C

**Recommended Operating Conditions**

|  | Min | Typ | Max | Units |
|--|-----|-----|-----|-------|
| Supply Voltage ( $V_{CC}$ )                      | 3.0 | 3.3 | 3.6 | V     |
| Receiver Differential Input Voltage ( $V_{ID}$ ) | 0   |     | 1   | V     |
| Operating Free Air Temperature ( $T_A$ )         | -40 | +25 | +85 | °C    |

**Electrical Characteristics**

Over recommended operating supply and temperature ranges unless otherwise specified. <sup>(1) (2) (3)</sup>

| Symbol                           | Parameter                | Conditions                         | Min | Typ | Max      | Units |
|----------------------------------|--------------------------|------------------------------------|-----|-----|----------|-------|
| <b>LVC MOS DC SPECIFICATIONS</b> |                          |                                    |     |     |          |       |
| $V_{IH}$                         | High Level Input Voltage |                                    | 2.0 |     | $V_{DD}$ | V     |
| $V_{IL}$                         | Low Level Input Voltage  |                                    | GND |     | 0.8      | V     |
| $I_{IH}$                         | High Level Input Current | $V_{IN} = 3.6V$<br>$V_{CC} = 3.6V$ |     | 0   | ±10      | μA    |

- (1) The Electrical Characteristics tables list guaranteed specifications under the listed Recommended Operating Conditions except as otherwise modified or specified by the Electrical Characteristics Conditions and/or Notes. Typical specifications are estimations only and are not guaranteed.
- (2) Current into device pins is defined as positive. Current out of device pins is defined as negative. All voltages are referenced to ground except  $V_{OD}$  and  $\Delta V_{OD}$ .
- (3) Typical values represent most likely parametric norms for  $V_{CC} = +3.3V$  and  $T_A = +25°C$ , and at the Recommended Operation Conditions at the time of product characterization and are not guaranteed.

## Electrical Characteristics (continued)

Over recommended operating supply and temperature ranges unless otherwise specified. <sup>(1)</sup> <sup>(2)</sup> <sup>(3)</sup>

| Symbol                               | Parameter   | Conditions  | Min  | Typ     | Max             | Units         |
|--------------------------------------|---|---|------|---------|-----------------|---------------|
| $I_{IL}$                             | Low Level Input Current   | $V_{IN} = \text{GND}$<br>$V_{CC} = 3.6\text{V}$   |      | 0       | $\pm 10$        | $\mu\text{A}$ |
| $V_{CL}$                             | Input Clamp Voltage   | $I_{CL} = -18\text{ mA}$ , $V_{CC} = 0\text{V}$   |      | -0.9    | -1.5            | V             |
| $V_{OL}$                             | Low Level Output Voltage  | $I_{OL} = 4\text{ mA}$  |      | 0.26    | 0.4             | V             |
| <b>LVDS INPUT DC SPECIFICATIONS</b>  |   |   |      |         |                 |               |
| $V_{ID}$                             | Input Differential Voltage                                      |   | 0    |         | 1               | V             |
| $V_{TH}$                             | Differential Input High Threshold                               | $V_{CM} = +0.05\text{V}$ or $V_{CC}-0.05\text{V}$   |      | 0       | +100            | mV            |
| $V_{TL}$                             | Differential Input Low Threshold                                |   | -100 | 0       |                 | mV            |
| $V_{CMR}$                            | Common Mode Voltage Range                                       | $V_{ID} = 100\text{ mV}$  | 0.05 |         | $V_{CC} - 0.05$ | V             |
| $I_{IN}$                             | Input Current   | $V_{IN} = +3.6\text{V}$ or $0\text{V}$<br>$V_{CC} = 3.6\text{V}$ or $0\text{V}$             |      | $\pm 1$ | $\pm 10$        | $\mu\text{A}$ |
| $C_{IN}$                             | Input Capacitance   | Any LVDS Input Pin to GND   |      | 1.7     |                 | pF            |
| $R_{IN}$                             | Input Termination Resistor                                      | Between IN+ and IN-   |      | 100     |                 | $\Omega$      |
| <b>LVDS OUTPUT DC SPECIFICATIONS</b> |   |   |      |         |                 |               |
| $V_{OD}$                             | Differential Output Voltage                                     |   | 250  | 350     | 450             | mV            |
| $\Delta V_{OD}$                      | Change in Magnitude of $V_{OD}$ for Complimentary Output States | $R_L = 100\Omega$   | -35  |         | 35              | mV            |
| $V_{OS}$                             | Offset Voltage  |   | 1.05 | 1.2     | 1.375           | V             |
| $\Delta V_{OS}$                      | Change in Magnitude of $V_{OS}$ for Complimentary Output States | $R_L = 100\Omega$   | -35  |         | 35              | mV            |
| $I_{OS}$                             | Output Short Circuit Current <sup>(4)</sup>                     | OUT to GND  |      | -35     | -55             | mA            |
|                                      |   | OUT to $V_{CC}$   |      | 7       | 55              | mA            |
| $C_{OUT}$                            | Output Capacitance  | Any LVDS Output Pin to GND  |      | 1.2     |                 | pF            |
| $R_{OUT}$                            | Output Termination Resistor                                     | Between OUT+ and OUT-   |      | 100     |                 | $\Omega$      |
| <b>SUPPLY CURRENT</b>                |   |   |      |         |                 |               |
| $I_{CC}$                             | Supply Current  | $\overline{PE} = \text{OFF}$ , $\overline{EQ} = \text{OFF}$<br>$\overline{PWDN} = \text{H}$ |      | 162     | 190             | mA            |
| $I_{CCZ}$                            | Power Down Supply Current                                       | $\overline{PWDN} = \text{L}$  |      | 55      | 63              | mA            |

(4) Output short circuit current ( $I_{OS}$ ) is specified as magnitude only, minus sign indicates direction only.

## AC Electrical Characteristics <sup>(1)</sup> <sup>(2)</sup>

Over recommended operating supply and temperature ranges unless otherwise specified.

| Symbol                               | Parameter  | Conditions        | Min | Typ | Max | Units |
|--------------------------------------|--|-------------------|-----|-----|-----|-------|
| <b>LVDS OUTPUT AC SPECIFICATIONS</b> |  |                   |     |     |     |       |
| $t_{PLHD}$                           | Differential Propagation Delay Low to High <sup>(3)</sup>        | $R_L = 100\Omega$ |     | 390 | 600 | ps    |
| $t_{PHLD}$                           | Differential Propagation Delay High to Low <sup>(3)</sup>        |                   |     | 400 | 600 | ps    |
| $t_{SKD1}$                           | Pulse Skew $ t_{PLHD} - t_{PHLD} $ <sup>(3)</sup> <sup>(4)</sup> |                   |     | 10  | 50  | ps    |

- (1) The Electrical Characteristics tables list guaranteed specifications under the listed Recommended Operating Conditions except as otherwise modified or specified by the Electrical Characteristics Conditions and/or Notes. Typical specifications are estimations only and are not guaranteed.
- (2) Typical values represent most likely parametric norms for  $V_{CC} = +3.3\text{V}$  and  $T_A = +25^\circ\text{C}$ , and at the Recommended Operation Conditions at the time of product characterization and are not guaranteed.
- (3) Specification is guaranteed by characterization and is not tested in production.
- (4)  $t_{SKD1}$ ,  $|t_{PLHD} - t_{PHLD}|$ , Pulse Skew, is the magnitude difference in differential propagation delay time between the positive going edge and the negative going edge of the same channel.

## AC Electrical Characteristics <sup>(1) (2)</sup> (continued)

Over recommended operating supply and temperature ranges unless otherwise specified.

| Symbol  | Parameter   | Conditions   | Min        | Typ  | Max  | Units       |
|---|---|--|------------|------|------|-------------|
| $t_{SKD2}$  | Channel to Channel Skew<br>(3) (5)                    |  |            | 18   | 65   | ps          |
| $t_{SKD3}$  | Part to Part Skew<br>(3) (6)                          |  |            | 50   | 170  | ps          |
| $t_{LHT}$   | Rise Time <sup>(3)</sup>                              | $R_L = 100\Omega$  |            | 80   | 160  | ps          |
| $t_{HLT}$   | Fall Time <sup>(3)</sup>                              |  |            | 80   | 160  | ps          |
| $t_{ON}$  | Any $\overline{PWDN}$ to Output Active Time           |  |            | 8    | 20   | $\mu s$     |
| $t_{OFF}$   | Any $\overline{PWDN}$ to Output Inactive Time         |  |            | 5    | 12   | ns          |
| <b>JITTER PERFORMANCE WITH EQ = Off, PE = Off <sup>(3)</sup> (Figure 5)</b>           |   |  |            |      |      |             |
| $t_{RJ1}$   | Random Jitter (RMS Value)                             | $V_{ID} = 350\text{ mV}$<br>$V_{CM} = 1.2\text{ V}$<br>Clock (RZ)    | 2.5 Gbps   | 0.5  | 1    | ps          |
| $t_{RJ2}$   | No Test Channels<br>(7)                               |  | 3.125 Gbps | 0.5  | 1    | ps          |
| $t_{DJ1}$   | Deterministic Jitter (Peak to Peak)                   | $V_{ID} = 350\text{ mV}$<br>$V_{CM} = 1.2\text{ V}$<br>K28.5 (NRZ)   | 2.5 Gbps   | 6    | 22   | ps          |
| $t_{DJ2}$   | No Test Channels<br>(8)                               |  | 3.125 Gbps | 10   | 29   | ps          |
| $t_{TJ1}$   | Total Jitter (Peak to Peak)                           | $V_{ID} = 350\text{ mV}$<br>$V_{CM} = 1.2\text{ V}$<br>PRBS-23 (NRZ) | 2.5 Gbps   | 0.04 | 0.09 | $U_{I,P-P}$ |
| $t_{TJ2}$   | No Test Channels<br>(9)                               |  | 3.125 Gbps | 0.06 | 0.14 | $U_{I,P-P}$ |
| <b>JITTER PERFORMANCE WITH EQ = Off, PE = On <sup>(3)</sup> (Figure 6, Figure 9)</b>  |   |  |            |      |      |             |
| $t_{RJ1B}$  | Random Jitter (RMS Value)                             | $V_{ID} = 350\text{ mV}$<br>$V_{CM} = 1.2\text{ V}$<br>Clock (RZ)    | 2.5 Gbps   | 0.5  | 1    | ps          |
| $t_{RJ2B}$  | Test Channel B<br>(7)                                 |  | 3.125 Gbps | 0.5  | 1    | ps          |
| $t_{DJ1B}$  | Deterministic Jitter (Peak to Peak)                   | $V_{ID} = 350\text{ mV}$<br>$V_{CM} = 1.2\text{ V}$<br>K28.5 (NRZ)   | 2.5 Gbps   | 7    | 15   | ps          |
| $t_{DJ2B}$  | Test Channel B<br>(8)                                 |  | 3.125 Gbps | 4    | 23   | ps          |
| $t_{TJ1B}$  | Total Jitter (Peak to Peak)                           | $V_{ID} = 350\text{ mV}$<br>$V_{CM} = 1.2\text{ V}$<br>PRBS-23 (NRZ) | 2.5 Gbps   | 0.05 | 0.10 | $U_{I,P-P}$ |
| $t_{TJ2B}$  | Test Channel B<br>(10)                                |  | 3.125 Gbps | 0.06 | 0.14 | $U_{I,P-P}$ |
| <b>JITTER PERFORMANCE WITH EQ = On, PE = Off <sup>(11)</sup> (Figure 7, Figure 9)</b> |   |  |            |      |      |             |
| $t_{RJ1D}$  | Random Jitter (RMS Value)                             | $V_{ID} = 350\text{ mV}$<br>$V_{CM} = 1.2\text{ V}$<br>Clock (RZ)    | 2.5 Gbps   | 0.5  | 1    | ps          |
| $t_{RJ2D}$  | Test Channel D<br>(12)                                |  | 3.125 Gbps | 0.5  | 1    | ps          |
| $t_{DJ1D}$  | Deterministic Jitter (Peak to Peak)                   | $V_{ID} = 350\text{ mV}$<br>$V_{CM} = 1.2\text{ V}$<br>K28.5 (NRZ)   | 2.5 Gbps   | 14   | 30   | ps          |
| $t_{DJ2D}$  | Test Channel D<br>(13)                                |  | 3.125 Gbps | 15   | 30   | ps          |
| $t_{TJ1D}$  | Total Jitter (Peak to Peak)                           | $V_{ID} = 350\text{ mV}$<br>$V_{CM} = 1.2\text{ V}$<br>PRBS-23 (NRZ) | 2.5 Gbps   | 0.08 | 0.15 | $U_{I,P-P}$ |
| $t_{TJ2D}$  | Test Channel D<br>(10)                                |  | 3.125 Gbps | 0.10 | 0.17 | $U_{I,P-P}$ |
| <b>JITTER PERFORMANCE WITH EQ = On, PE = On <sup>(11)</sup> (Figure 8, Figure 9)</b>  |   |  |            |      |      |             |
| $t_{RJ1BD}$   | Random Jitter (RMS Value)                             | $V_{ID} = 350\text{ mV}$<br>$V_{CM} = 1.2\text{ V}$<br>Clock (RZ)    | 2.5 Gbps   | 0.5  | 1    | ps          |
| $t_{RJ2BD}$   | Input Test Channel D<br>Output Test Channel B<br>(12) |  | 3.125 Gbps | 0.5  | 1    | ps          |

- (5)  $t_{SKD2}$ , Channel to Channel Skew, is the difference in propagation delay ( $t_{PLHD}$  or  $t_{PHLD}$ ) among all output channels in Broadcast mode (any one input to all outputs).
- (6)  $t_{SKD3}$ , Part to Part Skew, is defined as the difference between the minimum and maximum differential propagation delays. This specification applies to devices at the same  $V_{CC}$  and within 5°C of each other within the operating temperature range.
- (7) Measured on a clock edge with a histogram and an accumulation of 1500 histogram hits. Input stimulus jitter is subtracted geometrically.
- (8) Tested with a combination of the 1100000101 (K28.5+ character) and 0011111010 (K28.5- character) patterns. Input stimulus jitter is subtracted algebraically.
- (9) Measured on an eye diagram with a histogram and an accumulation of 3500 histogram hits. Input stimulus jitter is subtracted.
- (10) Measured on an eye diagram with a histogram and an accumulation of 3500 histogram hits. Input stimulus jitter is subtracted.
- (11) Specification is guaranteed by characterization and is not tested in production.
- (12) Measured on a clock edge with a histogram and an accumulation of 1500 histogram hits. Input stimulus jitter is subtracted geometrically.
- (13) Tested with a combination of the 1100000101 (K28.5+ character) and 0011111010 (K28.5- character) patterns. Input stimulus jitter is subtracted algebraically.

**AC Electrical Characteristics <sup>(1)</sup> <sup>(2)</sup> (continued)**

Over recommended operating supply and temperature ranges unless otherwise specified.

| Symbol      | Parameter  | Conditions  | Min      | Typ  | Max               | Units             |
|-------------|--|---|----------|------|-------------------|-------------------|
| $t_{DJ1BD}$ | Deterministic Jitter (Peak to Peak)<br>Input Test Channel D<br>Output Test Channel B<br>(13) | $V_{ID} = 350\text{ mV}$<br>$V_{CM} = 1.2\text{V}$<br>K28.5 (NRZ)   | 2.5 Gbps | 11   | 23                | ps                |
| $t_{DJ2BD}$ |  | 3.125 Gbps  | 5        | 24   | ps                |                   |
| $t_{TJ1BD}$ | Total Jitter (Peak to Peak)<br>Input Test Channel D<br>Output Test Channel B<br>(10)         | $V_{ID} = 350\text{ mV}$<br>$V_{CM} = 1.2\text{V}$<br>PRBS-23 (NRZ) | 2.5 Gbps | 0.08 | 0.14              | UI <sub>P-P</sub> |
| $t_{TJ2BD}$ |  | 3.125 Gbps  | 0.10     | 0.20 | UI <sub>P-P</sub> |                   |

DC TEST CIRCUITS

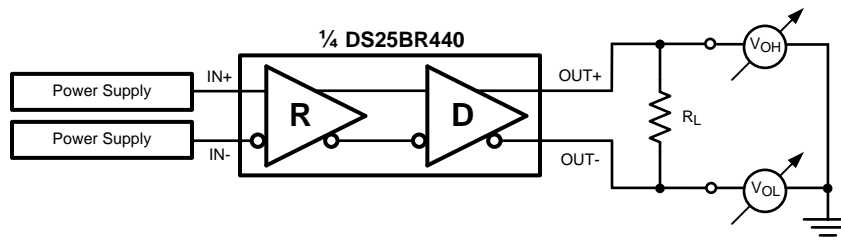

Figure 1. Differential Driver DC Test Circuit

AC Test Circuits and Timing Diagrams

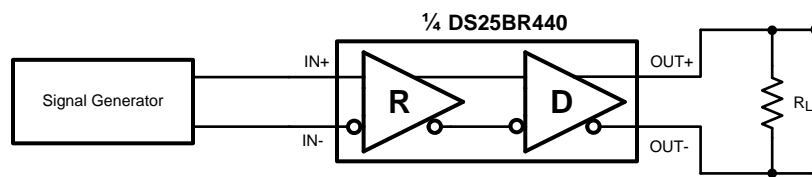

Figure 2. Differential Driver AC Test Circuit

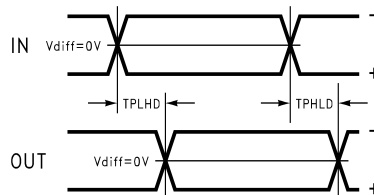

Figure 3. Propagation Delay Timing Diagram

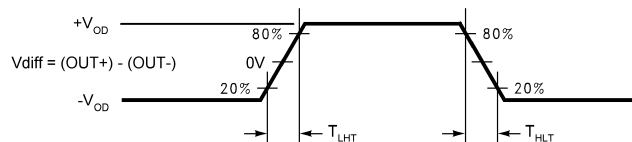

Figure 4. LVDS Output Transition Times

Pre-Emphasis and Equalization Test Circuits

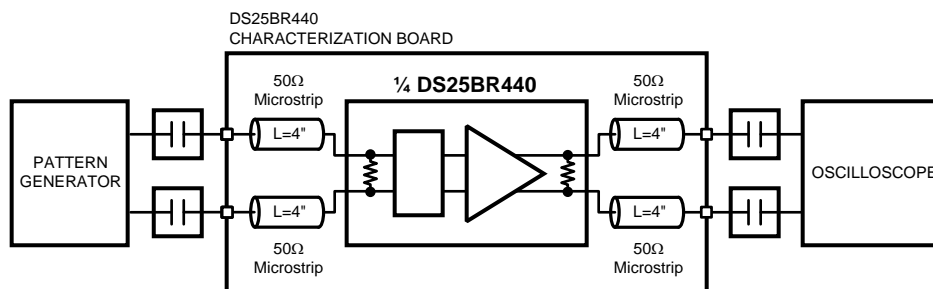

Figure 5. Jitter Performance Test Circuit



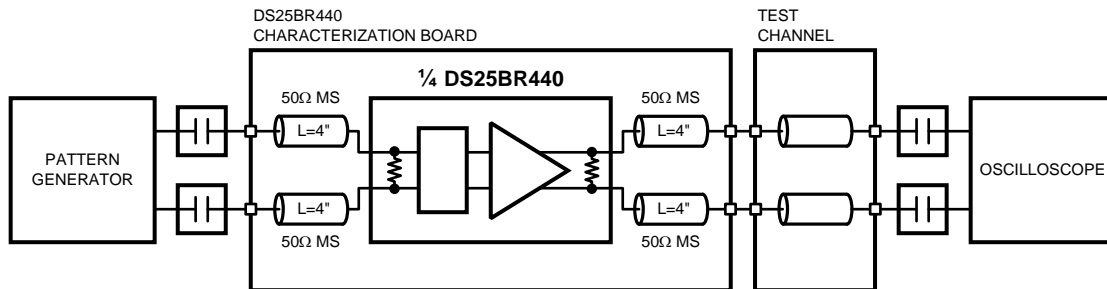

Figure 6. Pre-emphasis Performance Test Circuit

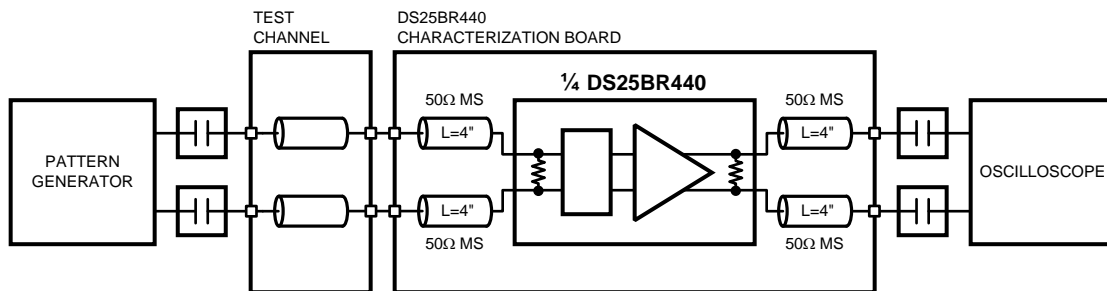

Figure 7. Equalization Performance Test Circuit

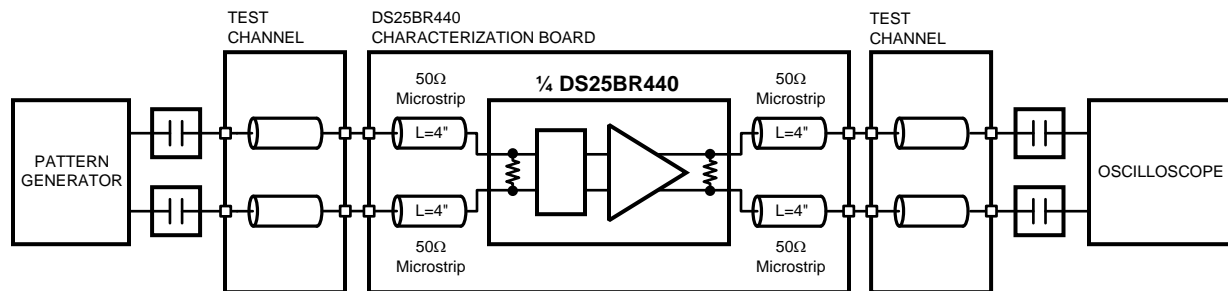

Figure 8. Pre-emphasis and Equalization Performance Test Circuit

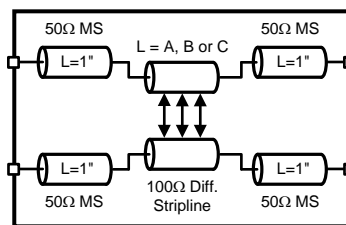

Figure 9. Test Channel Block Diagram

### Test Channel Loss Characteristics

The test channel was fabricated with Polyclad PCL-FR-370-Laminates/PCL-FRP-370 Prepreg materials (Dielectric constant of 3.7 and Loss Tangent of 0.02). The edge coupled differential striplines have the following geometries: Trace Width (W) = 5 mils, Gap (S) = 5 mils, Height (B) = 16 mils.

| Test Channel | Length (inches) | Insertion Loss (dB) |         |          |          |          |          |
|--------------|-----------------|---------------------|---------|----------|----------|----------|----------|
|              |                 | 500 MHz             | 750 MHz | 1000 MHz | 1250 MHz | 1500 MHz | 1560 MHz |
| A            | 10              | -1.2                | -1.7    | -2.0     | -2.4     | -2.7     | -2.8     |
| B            | 20              | -2.6                | -3.5    | -4.1     | -4.8     | -5.5     | -5.6     |
| C            | 30              | -4.3                | -5.7    | -7.0     | -8.2     | -9.4     | -9.7     |
| D            | 15              | -1.6                | -2.2    | -2.7     | -3.2     | -3.7     | -3.8     |
| E            | 30              | -3.4                | -4.5    | -5.6     | -6.6     | -7.7     | -7.9     |
| F            | 60              | -7.8                | -10.3   | -12.4    | -14.5    | -16.6    | -17.0    |

## Functional Description

The DS25BR440 is a 3.125 Gbps Quad LVDS buffer optimized for high-speed signal routing and repeating over lossy FR-4 printed circuit board backplanes and balanced cables.

The DS25BR440 has a pre-emphasis control pin for each output for switching the transmit pre-emphasis to ON and OFF setting and an equalization control pin for each input for switching the receive equalization to ON and OFF setting. The following are the transmit pre-emphasis and receive equalization truth tables.

**Table 1. Transmit Pre-Emphasis Truth Table<sup>(1)</sup>**

| OUTPUT OUT <sub>n</sub> , n = {0, 1, 2, 3} |                    |
|--|--------------------|
| CONTROL Pin (PE <sub>n</sub> ) State       | Pre-emphasis Level |
| 0  | OFF                |
| 1  | ON                 |

(1) Transmit Pre-emphasis Level Selection for an Output OUT<sub>n</sub>

**Table 2. Receive Equalization Truth Table<sup>(1)</sup>**

| INPUT IN <sub>n</sub> , n = {0, 1, 2, 3} |                    |
|--|--------------------|
| CONTROL Pin (EQ <sub>n</sub> ) State     | Equalization Level |
| 0  | OFF                |
| 1  | ON                 |

(1) Receive Equalization Level Selection for an Input IN<sub>n</sub>

## Input Interfacing

The DS25BR440 accepts differential signals and allows simple AC or DC coupling. With a wide common mode range, the DS25BR440 can be DC-coupled with all common differential drivers (i.e. LVPECL, LVDS, CML). The following three figures illustrate typical DC-coupled interface to common differential drivers. Note that the DS25BR440 inputs are internally terminated with a 100Ω resistor.

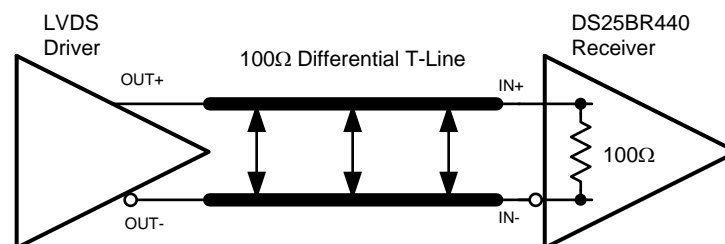

**Figure 10. Typical LVDS Driver DC-Coupled Interface to an DS25BR440 Input**

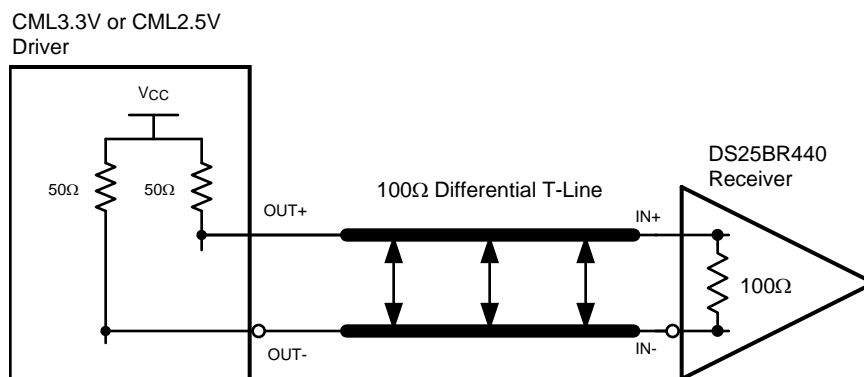

Figure 11. Typical CML Driver DC-Coupled Interface to an DS25BR440 Input

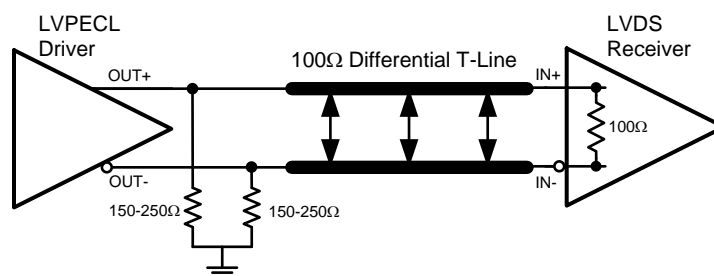

Figure 12. Typical LVPECL Driver DC-Coupled Interface to an DS25BR440 Input

### Output Interfacing

The DS25BR440 outputs signals compliant to the LVDS standard. Its outputs can be DC-coupled to most common differential receivers. The following figure illustrates typical DC-coupled interface to common differential receivers and assumes that the receivers have high impedance inputs. While most differential receivers have a common mode input range that can accommodate LVDS compliant signals, it is recommended to check the respective receiver's data sheet prior to implementing the suggested interface implementation.

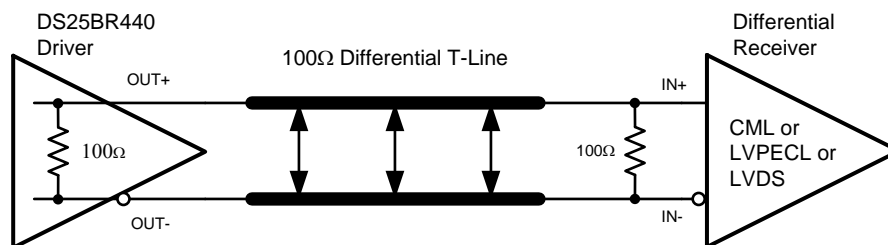

Figure 13. Typical DS25BR440 Output DC-Coupled Interface to an LVDS, CML or LVPECL Receiver

Typical Performance

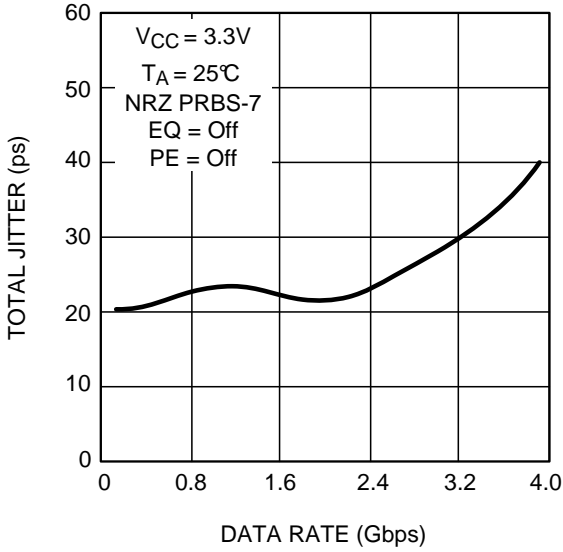

Figure 14. Total Jitter as a Function of Data Rate

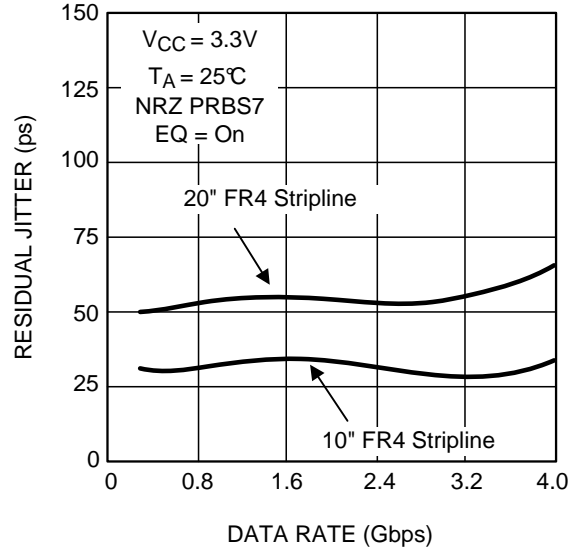

Figure 15. Residual Jitter as a Function of Data Rate, FR4 Stripline Length and EQ Level

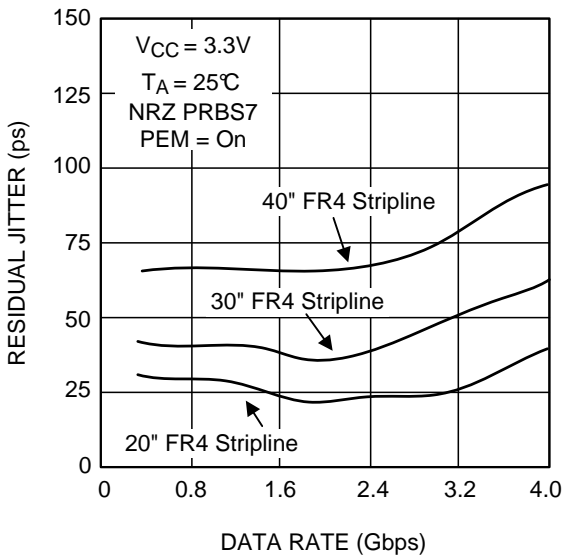

Figure 16. Residual Jitter as a Function of Data Rate, FR4 Stripline Length and PE Level

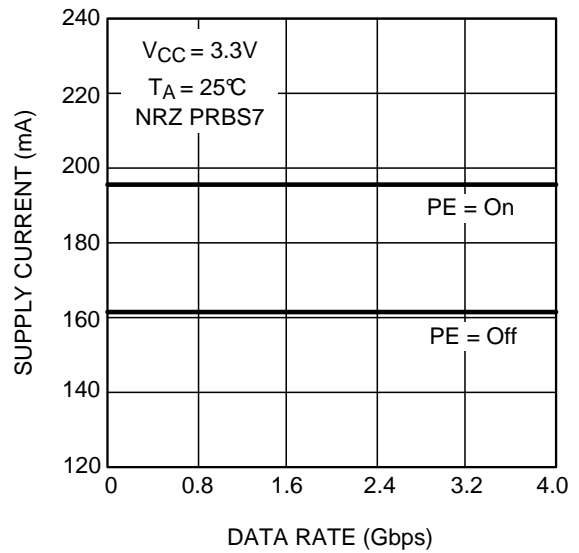

Figure 17. Supply Current as a Function of Data Rate and PE Level



---

**REVISION HISTORY**

| <b>Changes from Revision A (March 2013) to Revision B</b>  | <b>Page</b>        |
|--|--------------------|
| • Changed layout of National Data Sheet to TI format ..... | <a href="#">12</a> |

---

**PACKAGING INFORMATION**

| Orderable Device   | Status<br>(1) | Package Type | Package Drawing | Pins | Package Qty | Eco Plan<br>(2)         | Lead/Ball Finish | MSL Peak Temp<br>(3) | Op Temp (°C) | Top-Side Markings<br>(4) | Samples   |
|--------------------|---------------|--------------|-----------------|------|-------------|-------------------------|------------------|----------------------|--------------|--------------------------|---|
| DS25BR440TSQ/NOPB  | ACTIVE        | WQFN         | RTA             | 40   | 250         | Green (RoHS & no Sb/Br) | SN               | Level-3-260C-168 HR  |              | 2BR440SQ                 |  |
| DS25BR440TSQX/NOPB | ACTIVE        | WQFN         | RTA             | 40   | 2500        | Green (RoHS & no Sb/Br) | SN               | Level-3-260C-168 HR  | -40 to 85    | 2BR440SQ                 |  |

(1) The marketing status values are defined as follows:

**ACTIVE:** Product device recommended for new designs.

**LIFEBUY:** TI has announced that the device will be discontinued, and a lifetime-buy period is in effect.

**NRND:** Not recommended for new designs. Device is in production to support existing customers, but TI does not recommend using this part in a new design.

**PREVIEW:** Device has been announced but is not in production. Samples may or may not be available.

**OBsolete:** TI has discontinued the production of the device.

(2) Eco Plan - The planned eco-friendly classification: Pb-Free (RoHS), Pb-Free (RoHS Exempt), or Green (RoHS & no Sb/Br) - please check <http://www.ti.com/productcontent> for the latest availability information and additional product content details.

**TBD:** The Pb-Free/Green conversion plan has not been defined.

**Pb-Free (RoHS):** TI's terms "Lead-Free" or "Pb-Free" mean semiconductor products that are compatible with the current RoHS requirements for all 6 substances, including the requirement that lead not exceed 0.1% by weight in homogeneous materials. Where designed to be soldered at high temperatures, TI Pb-Free products are suitable for use in specified lead-free processes.

**Pb-Free (RoHS Exempt):** This component has a RoHS exemption for either 1) lead-based flip-chip solder bumps used between the die and package, or 2) lead-based die adhesive used between the die and leadframe. The component is otherwise considered Pb-Free (RoHS compatible) as defined above.

**Green (RoHS & no Sb/Br):** TI defines "Green" to mean Pb-Free (RoHS compatible), and free of Bromine (Br) and Antimony (Sb) based flame retardants (Br or Sb do not exceed 0.1% by weight in homogeneous material)

(3) MSL, Peak Temp. -- The Moisture Sensitivity Level rating according to the JEDEC industry standard classifications, and peak solder temperature.

(4) Multiple Top-Side Markings will be inside parentheses. Only one Top-Side Marking contained in parentheses and separated by a "~" will appear on a device. If a line is indented then it is a continuation of the previous line and the two combined represent the entire Top-Side Marking for that device.

**Important Information and Disclaimer:** The information provided on this page represents TI's knowledge and belief as of the date that it is provided. TI bases its knowledge and belief on information provided by third parties, and makes no representation or warranty as to the accuracy of such information. Efforts are underway to better integrate information from third parties. TI has taken and continues to take reasonable steps to provide representative and accurate information but may not have conducted destructive testing or chemical analysis on incoming materials and chemicals. TI and TI suppliers consider certain information to be proprietary, and thus CAS numbers and other limited information may not be available for release.

In no event shall TI's liability arising out of such information exceed the total purchase price of the TI part(s) at issue in this document sold by TI to Customer on an annual basis.

**TAPE AND REEL INFORMATION**

**QUADRANT ASSIGNMENTS FOR PIN 1 ORIENTATION IN TAPE**

\*All dimensions are nominal

| Device             | Package Type | Package Drawing | Pins | SPQ  | Reel Diameter (mm) | Reel Width W1 (mm) | A0 (mm) | B0 (mm) | K0 (mm) | P1 (mm) | W (mm) | Pin1 Quadrant |
|--------------------|--------------|-----------------|------|------|--------------------|--------------------|---------|---------|---------|---------|--------|---------------|
| DS25BR440TSQ/NOPB  | WQFN         | RTA             | 40   | 250  | 178.0              | 16.4               | 6.3     | 6.3     | 1.5     | 12.0    | 16.0   | Q1            |
| DS25BR440TSQX/NOPB | WQFN         | RTA             | 40   | 2500 | 330.0              | 16.4               | 6.3     | 6.3     | 1.5     | 12.0    | 16.0   | Q1            |

TAPE AND REEL BOX DIMENSIONS



\*All dimensions are nominal

| Device             | Package Type | Package Drawing | Pins | SPQ  | Length (mm) | Width (mm) | Height (mm) |
|--------------------|--------------|-----------------|------|------|-------------|------------|-------------|
| DS25BR440TSQ/NOPB  | WQFN         | RTA             | 40   | 250  | 213.0       | 191.0      | 55.0        |
| DS25BR440TSQX/NOPB | WQFN         | RTA             | 40   | 2500 | 367.0       | 367.0      | 38.0        |



RTA0040A

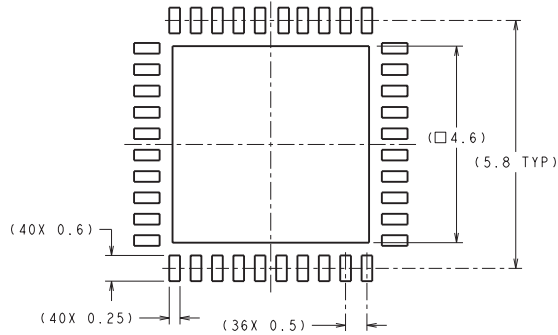

DIMENSIONS ARE IN MILLIMETERS  
DIMENSIONS IN ( ) FOR REFERENCE ONLY

RECOMMENDED LAND PATTERN

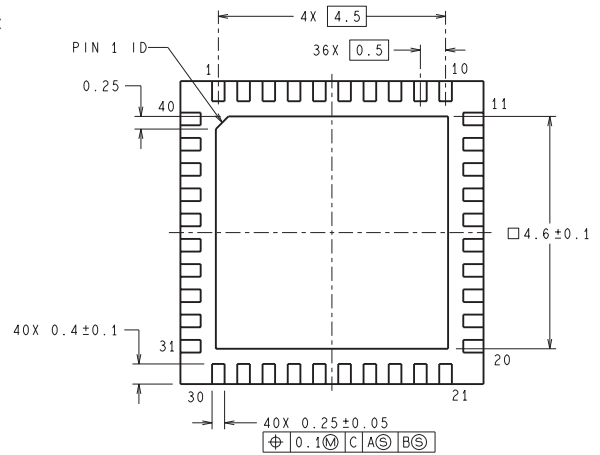
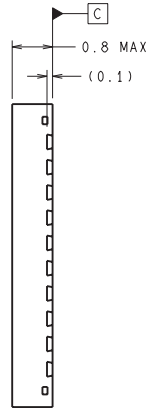
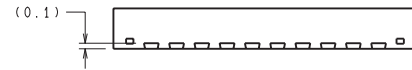
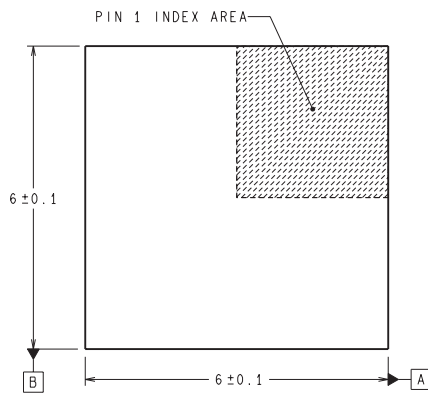

SQA40A (Rev B)

## IMPORTANT NOTICE

Texas Instruments Incorporated and its subsidiaries (TI) reserve the right to make corrections, enhancements, improvements and other changes to its semiconductor products and services per JESD46, latest issue, and to discontinue any product or service per JESD48, latest issue. Buyers should obtain the latest relevant information before placing orders and should verify that such information is current and complete. All semiconductor products (also referred to herein as "components") are sold subject to TI's terms and conditions of sale supplied at the time of order acknowledgment.

TI warrants performance of its components to the specifications applicable at the time of sale, in accordance with the warranty in TI's terms and conditions of sale of semiconductor products. Testing and other quality control techniques are used to the extent TI deems necessary to support this warranty. Except where mandated by applicable law, testing of all parameters of each component is not necessarily performed.

TI assumes no liability for applications assistance or the design of Buyers' products. Buyers are responsible for their products and applications using TI components. To minimize the risks associated with Buyers' products and applications, Buyers should provide adequate design and operating safeguards.

TI does not warrant or represent that any license, either express or implied, is granted under any patent right, copyright, mask work right, or other intellectual property right relating to any combination, machine, or process in which TI components or services are used. Information published by TI regarding third-party products or services does not constitute a license to use such products or services or a warranty or endorsement thereof. Use of such information may require a license from a third party under the patents or other intellectual property of the third party, or a license from TI under the patents or other intellectual property of TI.

Reproduction of significant portions of TI information in TI data books or data sheets is permissible only if reproduction is without alteration and is accompanied by all associated warranties, conditions, limitations, and notices. TI is not responsible or liable for such altered documentation. Information of third parties may be subject to additional restrictions.

Resale of TI components or services with statements different from or beyond the parameters stated by TI for that component or service voids all express and any implied warranties for the associated TI component or service and is an unfair and deceptive business practice. TI is not responsible or liable for any such statements.

Buyer acknowledges and agrees that it is solely responsible for compliance with all legal, regulatory and safety-related requirements concerning its products, and any use of TI components in its applications, notwithstanding any applications-related information or support that may be provided by TI. Buyer represents and agrees that it has all the necessary expertise to create and implement safeguards which anticipate dangerous consequences of failures, monitor failures and their consequences, lessen the likelihood of failures that might cause harm and take appropriate remedial actions. Buyer will fully indemnify TI and its representatives against any damages arising out of the use of any TI components in safety-critical applications.

In some cases, TI components may be promoted specifically to facilitate safety-related applications. With such components, TI's goal is to help enable customers to design and create their own end-product solutions that meet applicable functional safety standards and requirements. Nonetheless, such components are subject to these terms.

No TI components are authorized for use in FDA Class III (or similar life-critical medical equipment) unless authorized officers of the parties have executed a special agreement specifically governing such use.

Only those TI components which TI has specifically designated as military grade or "enhanced plastic" are designed and intended for use in military/aerospace applications or environments. Buyer acknowledges and agrees that any military or aerospace use of TI components which have **not** been so designated is solely at the Buyer's risk, and that Buyer is solely responsible for compliance with all legal and regulatory requirements in connection with such use.

TI has specifically designated certain components as meeting ISO/TS16949 requirements, mainly for automotive use. In any case of use of non-designated products, TI will not be responsible for any failure to meet ISO/TS16949.

### Products

|                              |  |
|------------------------------|--|
| Audio                        | <a href="http://www.ti.com/audio">www.ti.com/audio</a>                               |
| Amplifiers                   | <a href="http://amplifier.ti.com">amplifier.ti.com</a>                               |
| Data Converters              | <a href="http://dataconverter.ti.com">dataconverter.ti.com</a>                       |
| DLP® Products                | <a href="http://www.dlp.com">www.dlp.com</a>   |
| DSP                          | <a href="http://dsp.ti.com">dsp.ti.com</a>   |
| Clocks and Timers            | <a href="http://www.ti.com/clocks">www.ti.com/clocks</a>                             |
| Interface                    | <a href="http://interface.ti.com">interface.ti.com</a>                               |
| Logic                        | <a href="http://logic.ti.com">logic.ti.com</a>                                       |
| Power Mgmt                   | <a href="http://power.ti.com">power.ti.com</a>                                       |
| Microcontrollers             | <a href="http://microcontroller.ti.com">microcontroller.ti.com</a>                   |
| RFID                         | <a href="http://www.ti-rfid.com">www.ti-rfid.com</a>                                 |
| OMAP Applications Processors | <a href="http://www.ti.com/omap">www.ti.com/omap</a>                                 |
| Wireless Connectivity        | <a href="http://www.ti.com/wirelessconnectivity">www.ti.com/wirelessconnectivity</a> |

### Applications

|                               |  |
|-------------------------------|--|
| Automotive and Transportation | <a href="http://www.ti.com/automotive">www.ti.com/automotive</a>                         |
| Communications and Telecom    | <a href="http://www.ti.com/communications">www.ti.com/communications</a>                 |
| Computers and Peripherals     | <a href="http://www.ti.com/computers">www.ti.com/computers</a>                           |
| Consumer Electronics          | <a href="http://www.ti.com/consumer-apps">www.ti.com/consumer-apps</a>                   |
| Energy and Lighting           | <a href="http://www.ti.com/energy">www.ti.com/energy</a>                                 |
| Industrial                    | <a href="http://www.ti.com/industrial">www.ti.com/industrial</a>                         |
| Medical                       | <a href="http://www.ti.com/medical">www.ti.com/medical</a>                               |
| Security                      | <a href="http://www.ti.com/security">www.ti.com/security</a>                             |
| Space, Avionics and Defense   | <a href="http://www.ti.com/space-avionics-defense">www.ti.com/space-avionics-defense</a> |
| Video and Imaging             | <a href="http://www.ti.com/video">www.ti.com/video</a>                                   |

### TI E2E Community

[e2e.ti.com](http://e2e.ti.com)