

# 54F190,74F190

*54F190 74F190 Up/Down Decade Counter with Preset and Ripple Clock*



Literature Number: SNOS167A

# 54F/74F190

## Up/Down Decade Counter with Preset and Ripple Clock

### General Description

The 'F190 is a reversible BCD (8421) decade counter featuring synchronous counting and asynchronous presetting. The preset feature allows the 'F190 to be used in programmable dividers. The Count Enable input, the Terminal Count output and the Ripple Clock output make possible a variety of methods of implementing multistage counters. In the counting modes, state changes are initiated by the rising edge of the clock.

### Features

- High-speed—125 MHz typical count frequency
- Synchronous counting
- Asynchronous parallel load
- Cascadable

Commercial	Military	Package Number	Package Description
74F190PC		N16E	16-Lead (0.300" Wide) Molded Dual-In-Line
	54F190DM (Note 2)	J16A	16-Lead Ceramic Dual-In-Line
74F190SC (Note 1)		M16A	16-Lead (0.150" Wide) Molded Small Outline, JEDEC
	54F190FM (Note 2)	W16A	16-Lead Cerpack
	54F190LM (Note 2)	E20A	20-Lead Ceramic Leadless Chip Carrier, Type C

**Note 1:** Devices also available in 13" reel. Use suffix = SCX.

**Note 2:** Military grade device with environmental and burn-in processing. Use suffix = DMOB, FMOB and LMOB.

### Logic Symbols

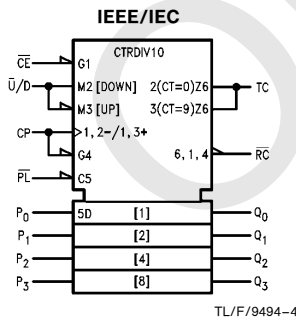
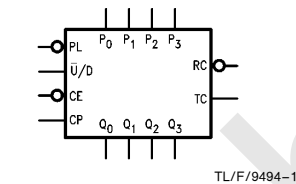

### Connection Diagrams

Pin Assignment for  
DIP, SOIC and Flatpak

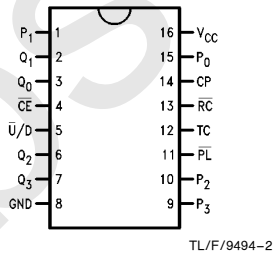

Pin Assignment  
for LCC

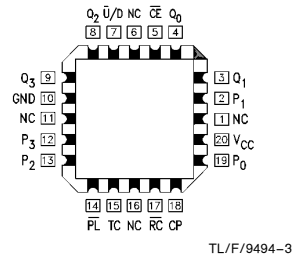

## Unit Loading/Fan Out



Pin Names	Description	54F/74F	
		U.L. HIGH/LOW	Input $I_{IH}/I_{IL}$ Output $I_{OH}/I_{OL}$
$\overline{CE}$	Count Enable Input (Active LOW)	1.0/3.0	20 $\mu$ A/ -1.8 mA
CP	Clock Pulse Input (Active Rising Edge)	1.0/1.0	20 $\mu$ A/ -0.6 mA
$P_0$ - $P_3$	Parallel Data Inputs	1.0/1.0	20 $\mu$ A/ -0.6 mA
$\overline{PL}$	Asynchronous Parallel Load Input (Active LOW)	1.0/1.0	20 $\mu$ A/ -0.6 mA
$\overline{U/D}$	Up/Down Count Control Input	1.0/1.0	20 $\mu$ A/ -0.6 mA
$Q_0$ - $Q_3$	Flip-Flop Outputs	50/33.3	-1 mA/20 mA
$\overline{RC}$	Ripple Clock Output (Active LOW)	50/33.3	-1 mA/20 mA
TC	Terminal Count Output (Active HIGH)	50/33.3	-1 mA/20 mA

## Functional Description



The 'F190 is a synchronous up/down BCD decade counter containing four edge-triggered flip-flops, with internal gating and steering logic to provide individual preset, count-up and count-down operations. It has an asynchronous parallel load capability permitting the counter to be preset to any desired number. When the Parallel Load ( $\overline{PL}$ ) input is LOW, information present on the Parallel Data inputs ( $P_0$ - $P_3$ ) is loaded into the counter and appears on the Q outputs. This operation overrides the counting functions, as indicated in the Mode Select Table. A HIGH signal on the  $\overline{CE}$  input inhibits counting. When  $\overline{CE}$  is LOW, internal state changes are initiated synchronously by the LOW-to-HIGH transition of the clock input. The direction of counting is determined by the  $\overline{U/D}$  input signal, as indicated in the Mode Select Table,  $\overline{CE}$  and  $\overline{U/D}$  can be changed with the clock in either state, provided only that the recommended setup and hold times are observed.



Two types of outputs are provided as overflow/underflow indicators. The Terminal Count (TC) output is normally LOW and goes HIGH when a circuit reaches zero in the count-down mode or reaches 9 in the count-up mode. The TC output will then remain HIGH until a state change occurs, whether by counting or presetting or until  $\overline{U/D}$  is changed. The TC output should not be used as a clock signal because it is subject to decoding spikes. The TC signal is also used internally to enable the Ripple Clock ( $\overline{RC}$ ) output. The  $\overline{RC}$  output is normally HIGH. When  $\overline{CE}$  is LOW and TC is HIGH, the  $\overline{RC}$  output will go LOW when the clock next goes LOW and will stay LOW until the clock goes HIGH again. This feature simplifies the design of multistage counters. For a discussion and illustrations of the various methods of implementing multistage counters, please see the 'F191 data sheet.

$\overline{RC}$  Truth Table

Inputs			Output
$\overline{CE}$	TC*	CP	$\overline{RC}$
L	H		
H	X	X	H
X	L	X	H

Mode Select Table

Inputs				Mode
$\overline{PL}$	$\overline{CE}$	$\overline{U/D}$	CP	
H	L	L		Count Up
H	L	H		Count Down
L	X	X	X	Preset (Asyn.)
H	H	X	X	No Change (Hold)

\*TC is generated internally  
H = HIGH Voltage Level  
L = LOW Voltage Level  
X = Immaterial  
 = LOW-to-HIGH Clock Transition  
 = LOW Pulse

## State Diagram

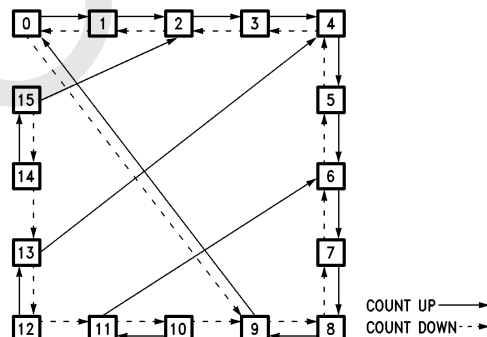

TL/F/9494-5

## Logic Diagram

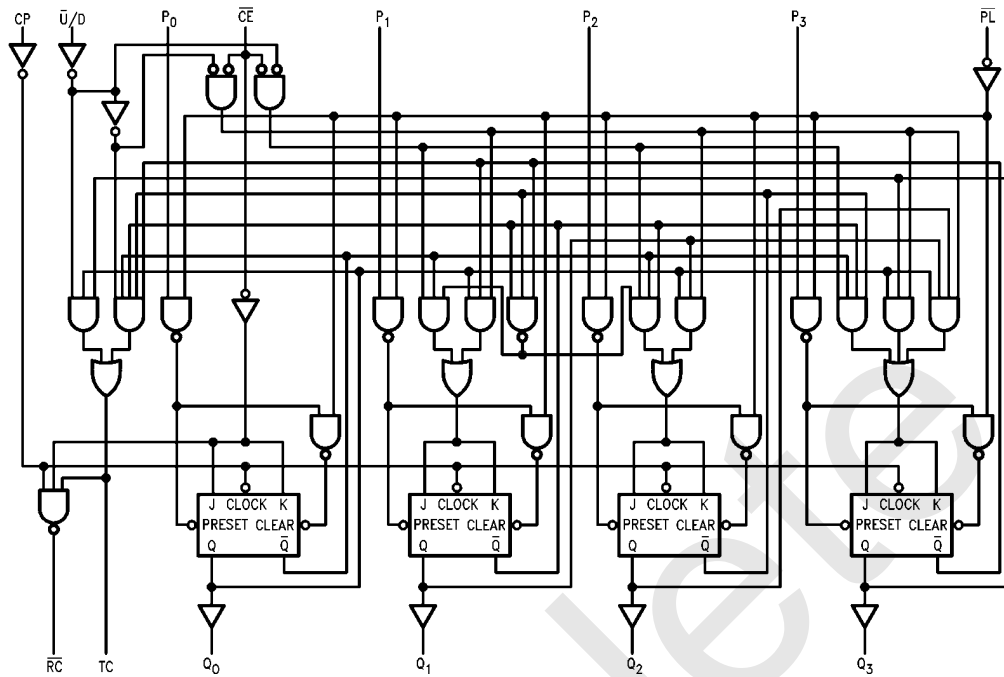

TL/F/9494-6

Please note that this diagram is provided only for the understanding of logic operations and should not be used to estimate propagation delays.

## Absolute Maximum Ratings (Note 1)

If Military/Aerospace specified devices are required, please contact the National Semiconductor Sales Office/Distributors for availability and specifications.

Storage Temperature	–65°C to +150°C
Ambient Temperature under Bias	–55°C to +125°C
Junction Temperature under Bias	–55°C to +175°C
Plastic	–55°C to +150°C
V <sub>CC</sub> Pin Potential to Ground Pin	–0.5V to +7.0V
Input Voltage (Note 2)	–0.5V to +7.0V
Input Current (Note 2)	–30 mA to +5.0 mA
Voltage Applied to Output in HIGH State (with V <sub>CC</sub> = 0V)	
Standard Output	–0.5V to V <sub>CC</sub>
TRI-STATE® Output	–0.5V to +5.5V

Current Applied to Output in LOW State (Max) twice the rated I<sub>OL</sub> (mA)

**Note 1:** Absolute maximum ratings are values beyond which the device may be damaged or have its useful life impaired. Functional operation under these conditions is not implied.

**Note 2:** Either voltage limit or current limit is sufficient to protect inputs.

## Recommended Operating Conditions

Free Air Ambient Temperature	
Military	–55°C to +125°C
Commercial	0°C to +70°C
Supply Voltage	
Military	+4.5V to +5.5V
Commercial	+4.5V to +5.5V

## DC Electrical Characteristics

Symbol	Parameter	54F/74F			Units	V <sub>CC</sub>	Conditions
		Min	Typ	Max			
V <sub>IH</sub>	Input HIGH Voltage	2.0			V		Recognized as a HIGH Signal
V <sub>IL</sub>	Input LOW Voltage			0.8	V		Recognized as a LOW Signal
V <sub>CD</sub>	Input Clamp Diode Voltage			–1.2	V	Min	I <sub>IN</sub> = –18 mA
V <sub>OH</sub>	Output HIGH Voltage	54F 10% V <sub>CC</sub> 74F 10% V <sub>CC</sub> 74F 5% V <sub>CC</sub>	2.5 2.5 2.7		V	Min	I <sub>OH</sub> = –1 mA I <sub>OH</sub> = –1 mA I <sub>OH</sub> = –1 mA
V <sub>OL</sub>	Output LOW Voltage	54F 10% V <sub>CC</sub> 74F 10% V <sub>CC</sub>		0.5 0.5	V	Min	I <sub>OL</sub> = 20 mA I <sub>OL</sub> = 20 mA
I <sub>IH</sub>	Input HIGH Current	54F 74F		20.0 5.0	μA	Max	V <sub>IN</sub> = 2.7V
I <sub>BVI</sub>	Input HIGH Current Breakdown Test	54F 74F		100 7.0	μA	Max	V <sub>IN</sub> = 7.0V
I <sub>CEX</sub>	Output HIGH Leakage Current	54F 74F		250 50	μA	Max	V <sub>OUT</sub> = V <sub>CC</sub>
V <sub>ID</sub>	Input Leakage Test	74F	4.75		V	0.0	I <sub>ID</sub> = 1.9 μA All Other Pins Grounded
I <sub>OD</sub>	Output Leakage Circuit Current	74F		3.75	μA	0.0	V <sub>IOD</sub> = 150 mV All Other Pins Grounded
I <sub>IL</sub>	Input LOW Current			–0.6 –1.8	mA	Max	V <sub>IN</sub> = 0.5V, except $\overline{CE}$ V <sub>IN</sub> = 0.5V, $\overline{CE}$
I <sub>OS</sub>	Output Short-Circuit Current		–60	–150	mA	Max	V <sub>OUT</sub> = 0V
I <sub>CCL</sub>	Power Supply Current		38	55	mA	Max	V <sub>O</sub> = LOW

## AC Electrical Characteristics

Symbol	Parameter	74F			54F		74F		Units
		$T_A = +25^\circ\text{C}$ $V_{CC} = +5.0\text{V}$ $C_L = 50\text{ pF}$			$T_A, V_{CC} = \text{Mil}$ $C_L = 50\text{ pF}$		$T_A, V_{CC} = \text{Com}$ $C_L = 50\text{ pF}$		
		Min	Typ	Max	Min	Max	Min	Max	
$f_{\text{max}}$	Maximum Clock Frequency	100	125		75		90		MHz
$t_{\text{PLH}}$ $t_{\text{PHL}}$	Propagation Delay CP to $Q_n$	3.0 5.0	5.5 8.5	7.5 11.0	3.0 5.0	9.5 13.5	3.0 5.0	8.5 12.0	ns
$t_{\text{PLH}}$ $t_{\text{PHL}}$	Propagation Delay CP to TC	6.0 5.0	10.0 8.5	13.0 11.0	6.0 5.0	16.5 13.5	6.0 5.0	14.0 12.0	
$t_{\text{PLH}}$ $t_{\text{PHL}}$	Propagation Delay CP to $\overline{\text{RC}}$	3.0 3.0	5.5 5.0	7.5 7.0	3.0 3.0	9.5 9.0	3.0 3.0	8.5 8.0	ns
$t_{\text{PLH}}$ $t_{\text{PHL}}$	Propagation Delay CE to RC	3.0 3.0	5.0 5.5	7.0 7.0	3.0 3.0	9.0 9.0	3.0 3.0	8.0 8.0	
$t_{\text{PLH}}$ $t_{\text{PHL}}$	Propagation Delay $\overline{\text{U/D}}$ to $\overline{\text{RC}}$	7.0 5.5	11.0 9.0	18.0 12.0	7.0 5.5	22.0 14.0	7.0 5.5	20.0 13.0	ns
$t_{\text{PLH}}$ $t_{\text{PHL}}$	Propagation Delay $\overline{\text{U/D}}$ to $\overline{\text{TC}}$	4.0 4.0	7.0 6.5	10.0 10.0	4.0 4.0	13.5 12.5	4.0 4.0	11.0 11.0	
$t_{\text{PLH}}$ $t_{\text{PHL}}$	Propagation Delay $P_n$ to $Q_n$	3.0 6.0	4.5 10.0	7.0 13.0	3.0 6.0	9.0 16.0	3.0 6.0	8.0 14.0	ns
$t_{\text{PLH}}$ $t_{\text{PHL}}$	Propagation Delay PL to $Q_n$	5.0 5.5	8.5 9.0	11.0 12.0	5.0 5.5	13.0 14.5	5.0 5.5	12.0 13.0	ns

## AC Operating Requirements

Symbol	Parameter	74F		54F		74F		Units
		$T_A = +25^\circ\text{C}$ $V_{CC} = +5.0\text{V}$		$T_A, V_{CC} = \text{Mil}$		$T_A, V_{CC} = \text{Com}$		
		Min	Max	Min	Max	Min	Max	
$t_{\text{s(H)}}$ $t_{\text{s(L)}}$	Setup Time, HIGH or LOW $P_n$ to $\overline{\text{PL}}$	4.5 4.5		6.0 6.0		5.0 5.0		ns
$t_{\text{h(H)}}$ $t_{\text{h(L)}}$	Hold Time, HIGH or LOW $P_n$ to $\overline{\text{PL}}$	2.0 2.0		2.0 2.0		2.0 2.0		
$t_{\text{s(L)}}$	Setup Time, LOW CE to CP	10.0		10.5		10.0		ns
$t_{\text{h(L)}}$	Hold Time, LOW CE to CP	0		0		0		
$t_{\text{s(H)}}$ $t_{\text{s(L)}}$	Setup Time, HIGH or LOW $\overline{\text{U/D}}$ to CP	12.0 12.0		12.0 12.0		12.0 12.0		ns
$t_{\text{h(H)}}$ $t_{\text{h(L)}}$	Hold Time, HIGH or LOW $\overline{\text{U/D}}$ to CP	0 0		0 0		0 0		
$t_{\text{w(L)}}$	$\overline{\text{PL}}$ Pulse Width, LOW	6.0		8.5		6.0		ns
$t_{\text{w(L)}}$	CP Pulse Width, LOW	5.0		7.0		5.0		ns
$t_{\text{rec}}$	Recovery Time $\overline{\text{PL}}$ to CP	6.0		7.5		6.0		ns

## Ordering Information

The device number is used to form part of a simplified purchasing code where the package type and temperature range are defined as follows:

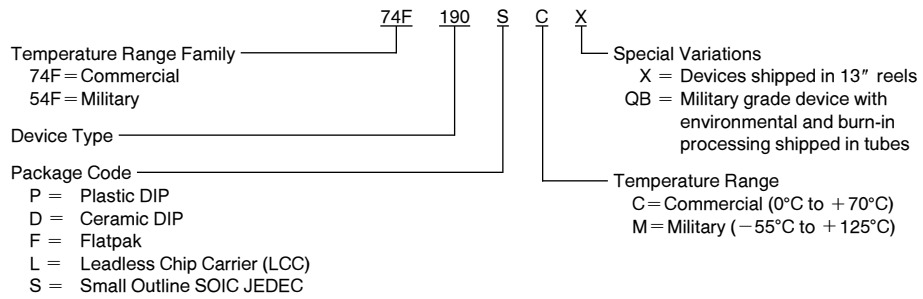

Obsolete

Obsolete



**Physical Dimensions** inches (millimeters)

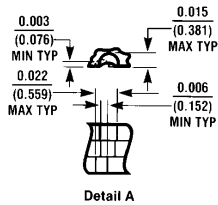
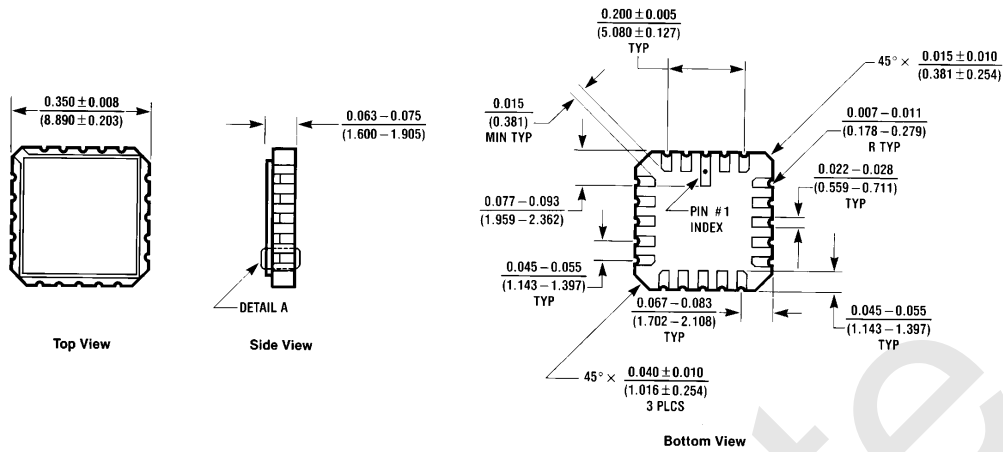

**20-Lead Ceramic Leadless Chip Carrier (L)**  
 NS Package Number E20A

E20A (REV D)

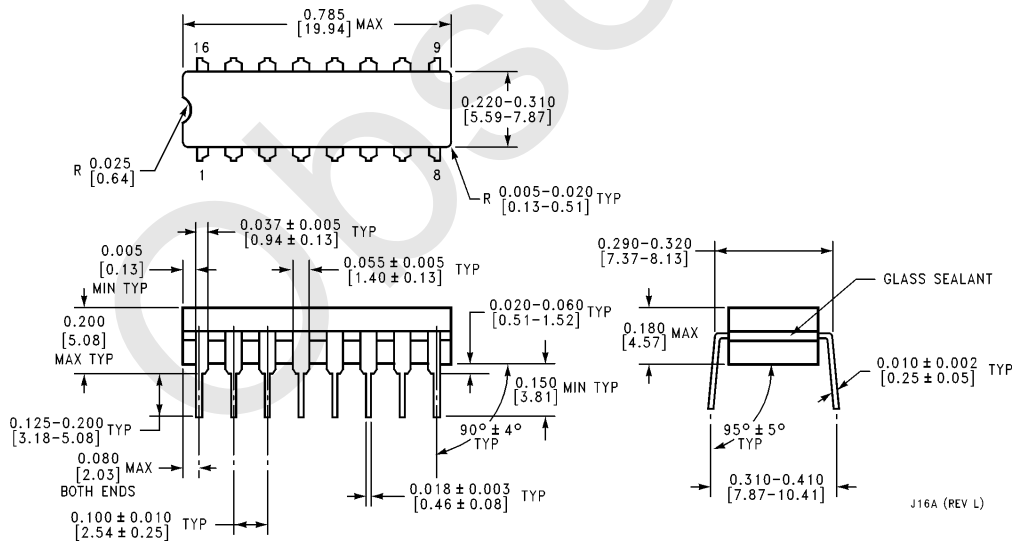

**16-Lead Ceramic Dual-In-Line Package (D)**  
 NS Package Number J16A

J16A (REV L)

**Physical Dimensions** inches (millimeters) (Continued)

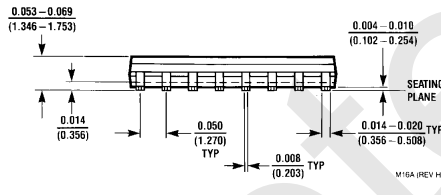
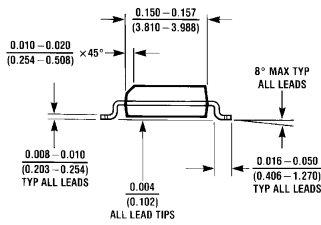
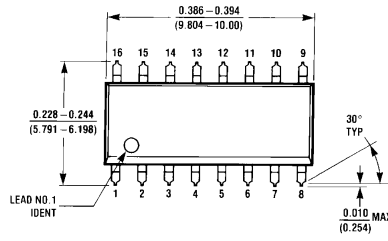

**16-Lead (0.150" Wide) Molded Small Outline Package, JEDEC (S)  
NS Package Number M16A**

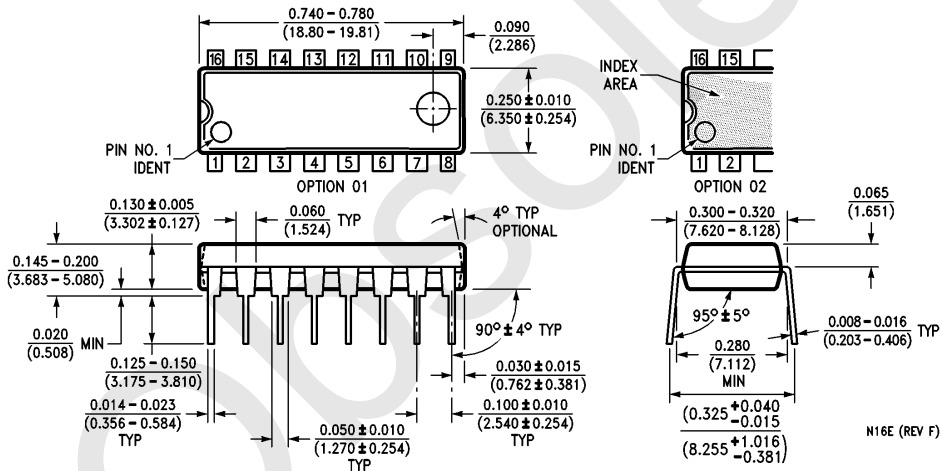

**16-Lead (0.300" Wide) Molded Dual-In-Line Package (P)  
NS Package Number N16E**

**Physical Dimensions** inches (millimeters) (Continued)

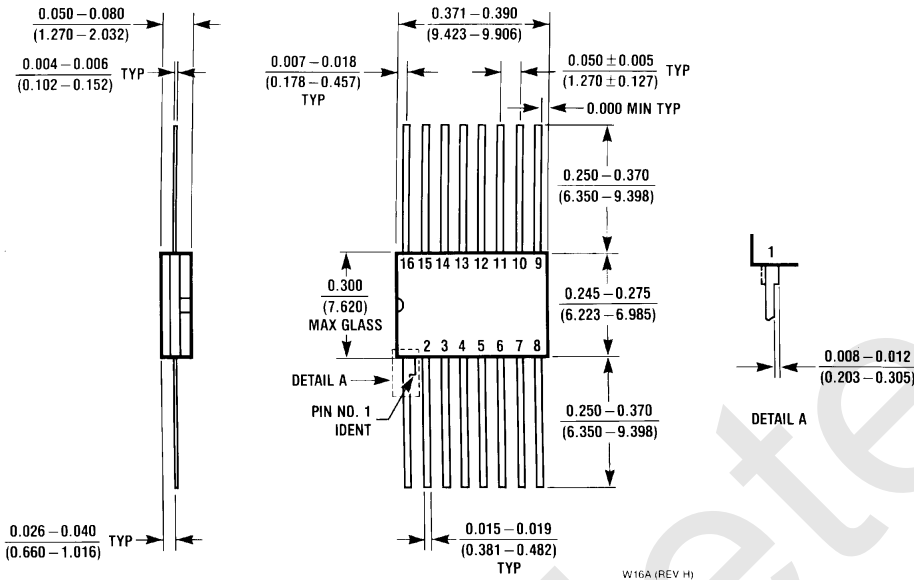

**16-Lead Ceramic Flatpak (F)  
NS Package Number W16A**

W16A (REV H)

**LIFE SUPPORT POLICY**

NATIONAL'S PRODUCTS ARE NOT AUTHORIZED FOR USE AS CRITICAL COMPONENTS IN LIFE SUPPORT DEVICES OR SYSTEMS WITHOUT THE EXPRESS WRITTEN APPROVAL OF THE PRESIDENT OF NATIONAL SEMICONDUCTOR CORPORATION. As used herein:

1. Life support devices or systems are devices or systems which, (a) are intended for surgical implant into the body, or (b) support or sustain life, and whose failure to perform, when properly used in accordance with instructions for use provided in the labeling, can be reasonably expected to result in a significant injury to the user.
2. A critical component is any component of a life support device or system whose failure to perform can be reasonably expected to cause the failure of the life support device or system, or to affect its safety or effectiveness.



**National Semiconductor Corporation**  
2900 Semiconductor Drive  
P.O. Box 58090  
Santa Clara, CA 95052-8090  
Tel: 1(800) 272-9959  
TWX: (910) 339-9240

**National Semiconductor GmbH**  
Livny-Gargan-Str. 10  
D-82256 Fürstenfeldbruck  
Germany  
Tel: (81-41) 35-0  
Telex: 527849  
Fax: (81-41) 35-1

**National Semiconductor Japan Ltd.**  
Sumitomo Chemical Engineering Center  
Bldg. 7F  
1-7-1, Nakase, Mihama-Ku  
Chiba-City,  
Ciba Prefecture 261  
Tel: (043) 299-2300  
Fax: (043) 299-2500

**National Semiconductor Hong Kong Ltd.**  
13th Floor, Straight Block,  
Ocean Centre, 5 Canton Rd.  
Tsimshatsui, Kowloon  
Hong Kong  
Tel: (852) 2737-1600  
Fax: (852) 2736-9960

**National Semicondutores Do Brazil Ltda.**  
Rue Deputado Lacorda Franco  
120-3A  
Sao Paulo-SP  
Brazil 05418-000  
Tel: (55-11) 212-5066  
Telex: 391-1131931 NSBR BR  
Fax: (55-11) 212-1181

**National Semiconductor (Australia) Pty. Ltd.**  
Building 16  
Business Park Drive  
Monash Business Park  
Nottingham, Melbourne  
Victoria 3168 Australia  
Tel: (3) 558-9999  
Fax: (3) 558-9998

National does not assume any responsibility for use of any circuitry described, no circuit patent licenses are implied and National reserves the right at any time without notice to change said circuitry and specifications.

## IMPORTANT NOTICE

Texas Instruments Incorporated and its subsidiaries (TI) reserve the right to make corrections, modifications, enhancements, improvements, and other changes to its products and services at any time and to discontinue any product or service without notice. Customers should obtain the latest relevant information before placing orders and should verify that such information is current and complete. All products are sold subject to TI's terms and conditions of sale supplied at the time of order acknowledgment.

TI warrants performance of its hardware products to the specifications applicable at the time of sale in accordance with TI's standard warranty. Testing and other quality control techniques are used to the extent TI deems necessary to support this warranty. Except where mandated by government requirements, testing of all parameters of each product is not necessarily performed.

TI assumes no liability for applications assistance or customer product design. Customers are responsible for their products and applications using TI components. To minimize the risks associated with customer products and applications, customers should provide adequate design and operating safeguards.

TI does not warrant or represent that any license, either express or implied, is granted under any TI patent right, copyright, mask work right, or other TI intellectual property right relating to any combination, machine, or process in which TI products or services are used. Information published by TI regarding third-party products or services does not constitute a license from TI to use such products or services or a warranty or endorsement thereof. Use of such information may require a license from a third party under the patents or other intellectual property of the third party, or a license from TI under the patents or other intellectual property of TI.

Reproduction of TI information in TI data books or data sheets is permissible only if reproduction is without alteration and is accompanied by all associated warranties, conditions, limitations, and notices. Reproduction of this information with alteration is an unfair and deceptive business practice. TI is not responsible or liable for such altered documentation. Information of third parties may be subject to additional restrictions.

Resale of TI products or services with statements different from or beyond the parameters stated by TI for that product or service voids all express and any implied warranties for the associated TI product or service and is an unfair and deceptive business practice. TI is not responsible or liable for any such statements.

TI products are not authorized for use in safety-critical applications (such as life support) where a failure of the TI product would reasonably be expected to cause severe personal injury or death, unless officers of the parties have executed an agreement specifically governing such use. Buyers represent that they have all necessary expertise in the safety and regulatory ramifications of their applications, and acknowledge and agree that they are solely responsible for all legal, regulatory and safety-related requirements concerning their products and any use of TI products in such safety-critical applications, notwithstanding any applications-related information or support that may be provided by TI. Further, Buyers must fully indemnify TI and its representatives against any damages arising out of the use of TI products in such safety-critical applications.

TI products are neither designed nor intended for use in military/aerospace applications or environments unless the TI products are specifically designated by TI as military-grade or "enhanced plastic." Only products designated by TI as military-grade meet military specifications. Buyers acknowledge and agree that any such use of TI products which TI has not designated as military-grade is solely at the Buyer's risk, and that they are solely responsible for compliance with all legal and regulatory requirements in connection with such use.

TI products are neither designed nor intended for use in automotive applications or environments unless the specific TI products are designated by TI as compliant with ISO/TS 16949 requirements. Buyers acknowledge and agree that, if they use any non-designated products in automotive applications, TI will not be responsible for any failure to meet such requirements.

Following are URLs where you can obtain information on other Texas Instruments products and application solutions:

### Products

Audio	<a href="http://www.ti.com/audio">www.ti.com/audio</a>
Amplifiers	<a href="http://amplifier.ti.com">amplifier.ti.com</a>
Data Converters	<a href="http://dataconverter.ti.com">dataconverter.ti.com</a>
DLP® Products	<a href="http://www.dlp.com">www.dlp.com</a>
DSP	<a href="http://dsp.ti.com">dsp.ti.com</a>
Clocks and Timers	<a href="http://www.ti.com/clocks">www.ti.com/clocks</a>
Interface	<a href="http://interface.ti.com">interface.ti.com</a>
Logic	<a href="http://logic.ti.com">logic.ti.com</a>
Power Mgmt	<a href="http://power.ti.com">power.ti.com</a>
Microcontrollers	<a href="http://microcontroller.ti.com">microcontroller.ti.com</a>
RFID	<a href="http://www.ti-rfid.com">www.ti-rfid.com</a>
OMAP Mobile Processors	<a href="http://www.ti.com/omap">www.ti.com/omap</a>
Wireless Connectivity	<a href="http://www.ti.com/wirelessconnectivity">www.ti.com/wirelessconnectivity</a>

### Applications

Communications and Telecom	<a href="http://www.ti.com/communications">www.ti.com/communications</a>
Computers and Peripherals	<a href="http://www.ti.com/computers">www.ti.com/computers</a>
Consumer Electronics	<a href="http://www.ti.com/consumer-apps">www.ti.com/consumer-apps</a>
Energy and Lighting	<a href="http://www.ti.com/energy">www.ti.com/energy</a>
Industrial	<a href="http://www.ti.com/industrial">www.ti.com/industrial</a>
Medical	<a href="http://www.ti.com/medical">www.ti.com/medical</a>
Security	<a href="http://www.ti.com/security">www.ti.com/security</a>
Space, Avionics and Defense	<a href="http://www.ti.com/space-avionics-defense">www.ti.com/space-avionics-defense</a>
Transportation and Automotive	<a href="http://www.ti.com/automotive">www.ti.com/automotive</a>
Video and Imaging	<a href="http://www.ti.com/video">www.ti.com/video</a>

TI E2E Community Home Page

[e2e.ti.com](http://e2e.ti.com)

Mailing Address: Texas Instruments, Post Office Box 655303, Dallas, Texas 75265  
Copyright © 2011, Texas Instruments Incorporated