

54F398,54F399,74F398,74F399

54F398 54F399 74F398 74F399 Quad 2-Port Register



Literature Number: SNOS195A

54F/74F398 • 54F/74F399 Quad 2-Port Register

General Description

The 'F398 and 'F399 are the logical equivalents of a quad 2-input multiplexer feeding into four edge-triggered flip-flops. A common Select input determines which of the two 4-bit words is accepted. The selected data enters the flip-flops on the rising edge of the clock. The 'F399 is the 16-pin version of the 'F398, with only the Q outputs of the flip-flops available.

Features

- Select inputs from two data sources
- Fully positive edge-triggered operation
- Both true and complement outputs—'F398
- Guaranteed 4000V minimum ESD protection—'F399

Commercial	Military	Package Number	Package Description
74F398PC		N20A	20-Lead (0.300" Wide) Molded Dual-In-Line
	54F398DM (Note 2)	J20A	20-Lead Ceramic Dual-In-Line
74F398SC (Note 1)		M20B	20-Lead (0.300" Wide) Molded Small Outline, JEDEC
	54F398FM (Note 2)	W20A	20-Lead Cerpack
	54F398LM (Note 2)	E20A	20-Lead Ceramic Leadless Chip Carrier, Type C
74F399PC		N20A	20-Lead (0.300" Wide) Molded Dual-In-Line
	54F399DM (Note 2)	J20A	20-Lead Ceramic Dual-In-Line
74F399SC (Note 1)		M20B	20-Lead (0.300" Wide) Molded Small Outline, JEDEC
74F399SJ (Note 1)		M20D	20-Lead (0.300" Wide) Molded Small Outline, EIAJ
	54F399FM (Note 2)	W20A	20-Lead Cerpack
	54F399LM (Note 2)	E20A	20-Lead Ceramic Leadless Chip Carrier, Type C

Note 1: Devices also available in 13" reel. Use suffix = SCX and SJX.

Note 2: Military grade device with environmental and burn-in processing. Use suffix = DMQB, FMQB and LMQB.

Connection Diagrams

'F398

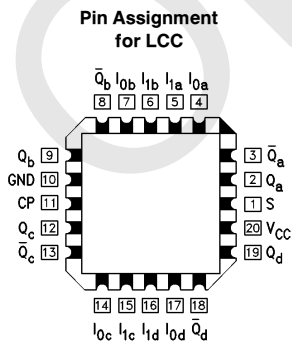

TL/F/9533-5

Pin Assignment for DIP, SOIC and Flatpak

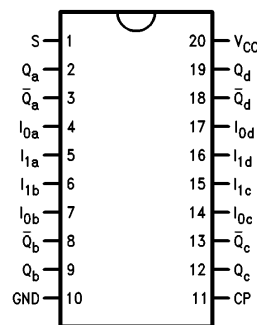

TL/F/9533-6

TRI-STATE® is a registered trademark of National Semiconductor Corporation.

Connection Diagrams (Continued)

'F399

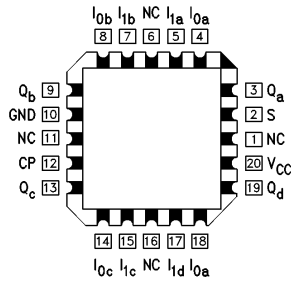

TL/F/9533-7

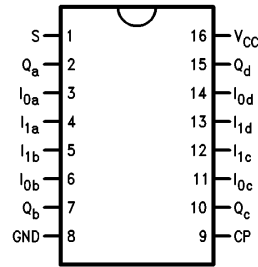

TL/F/9533-8

Logic Symbols

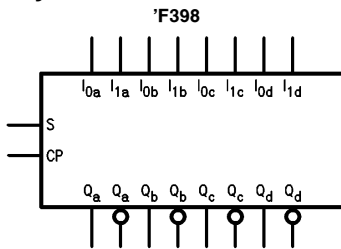

TL/F/9533-2

IEEE/IEC
'F398

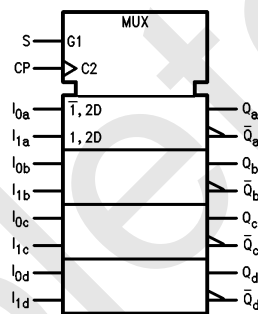

TL/F/9533-1

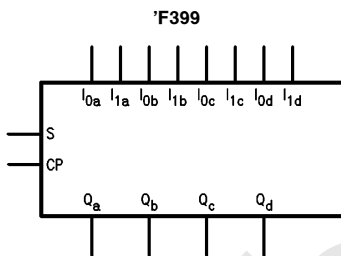

TL/F/9533-4

'F399

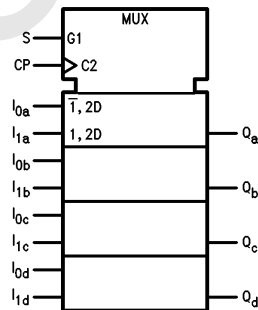

TL/F/9533-3

Unit Loading/Fan Out

Pin Names	Description	54F/74F	
		U.L. HIGH/LOW	Input I_{IH}/I_{IL} Output I_{OH}/I_{OL}
S	Common Select Input	1.0/1.0	20 μ A/ -0.6 mA
CP	Clock Pulse Input (Active Rising Edge)	1.0/1.0	20 μ A/ -0.6 mA
$I_{0a}-I_{0d}$	Data Inputs from Source 0	1.0/1.0	20 μ A/ -0.6 mA
$I_{1a}-I_{1d}$	Data Inputs from Source 1	1.0/1.0	20 μ A/ -0.6 mA
Q_a-Q_d	Register True Outputs	50/33.3	-1 mA/20 mA
$\bar{Q}_a-\bar{Q}_d$	Register Complementary Outputs ('F398)	50/33.3	-1 mA/20 mA

Functional Description

The 'F398 and 'F399 are high-speed quad 2-port registers. They select four bits of data from either of two sources (Ports) under control of a common Select input (S). The selected data is transferred to a 4-bit output register synchronous with the LOW-to-HIGH transition of the Clock input (CP). The 4-bit D-type output register is fully edge-triggered. The Data inputs (I_{0x} , I_{1x}) and Select input (S) must be stable only a setup time prior to and hold time after the LOW-to-HIGH transition of the Clock input for predictable operation. The 'F398 has both Q and \bar{Q} outputs.

Function Table

Inputs			Outputs	
S	I_0	I_1	Q	\bar{Q}^*
l	l	X	L	H
l	h	X	H	L
h	X	l	L	H
h	X	h	H	L

H = HIGH Voltage Level
 L = LOW Voltage Level
 h = HIGH Voltage Level one setup time prior to the LOW-to-HIGH clock transition
 l = LOW Voltage Level one setup time prior to the LOW-to-HIGH clock transition
 X = Immaterial
 *'F398 only

Logic Diagram

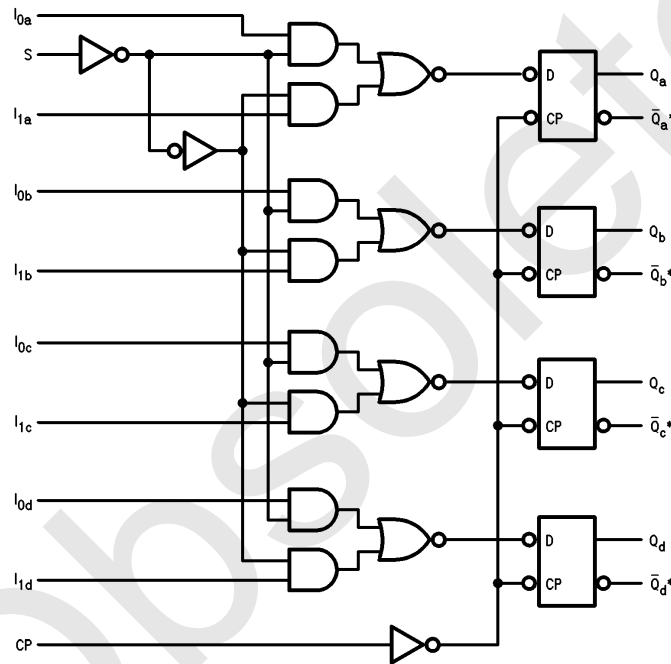

TL/F/9533-9

**F398 Only

Please note that this diagram is provided only for the understanding of logic operations and should not be used to estimate propagation delays.

Absolute Maximum Ratings (Note 1)

If Military/Aerospace specified devices are required, please contact the National Semiconductor Sales Office/Distributors for availability and specifications.

Storage Temperature	-65°C to +150°C
Ambient Temperature under Bias	-55°C to +125°C
Junction Temperature under Bias	-55°C to +175°C
Plastic	-55°C to +150°C

V_{CC} Pin Potential to Ground Pin -0.5V to +7.0V

Input Voltage (Note 2) -0.5V to +7.0V

Input Current (Note 2) -30 mA to +5.0 mA

Voltage Applied to Output in HIGH State (with V_{CC} = 0V)
 Standard Output -0.5V to V_{CC}
 TRI-STATE® Output -0.5V to +5.5V

Current Applied to Output in LOW State (Max) twice the rated I_{OL} (mA)

ESD Last Passing Voltage (Min)—F399 4000V

Note 1: Absolute maximum ratings are values beyond which the device may be damaged or have its useful life impaired. Functional operation under these conditions is not implied.

Note 2: Either voltage limit or current limit is sufficient to protect inputs.

Recommended Operating Conditions

Free Air Ambient Temperature	
Military	-55°C to +125°C
Commercial	0°C to +70°C
Supply Voltage	
Military	+4.5V to +5.5V
Commercial	+4.5V to +5.5V

DC Electrical Characteristics

Symbol	Parameter	54F/74F			Units	V _{CC}	Conditions
		Min	Typ	Max			
V _{IH}	Input HIGH Voltage	2.0			V		Recognized as a HIGH Signal
V _{IL}	Input LOW Voltage				V		Recognized as a LOW Signal
V _{CD}	Input Clamp Diode Voltage				V	Min	I _{IN} = -18 mA
V _{OH}	Output HIGH Voltage	54F 10% V _{CC}	2.5		V	Min	I _{OH} = -1 mA
		74F 10% V _{CC}	2.5				I _{OH} = -1 mA
		74F 5% V _{CC}	2.7				I _{OH} = -1 mA
V _{OL}	Output LOW Voltage	54F 10% V _{CC}		0.5	V	Min	I _{OL} = 20 mA
		74F 10% V _{CC}		0.5			I _{OL} = 20 mA
I _{IH}	Input HIGH Current	54F		20.0	μA	Max	V _{IN} = 2.7V
		74F		5.0			
I _{BVI}	Input HIGH Current Breakdown Test	54F		100	μA	Max	V _{IN} = 7.0V
		74F		7.0			
I _{CEX}	Output HIGH Leakage Current	54F		250	μA	Max	V _{OUT} = V _{CC}
		74F		50			
V _{ID}	Input Leakage Test	74F	4.75		V	0.0	I _{ID} = 1.9 μA All Other Pins Grounded
I _{OD}	Output Leakage Circuit Current	74F		3.75	μA	0.0	V _{IOD} = 150 mV All Other Pins Grounded
I _{IL}	Input LOW Current				mA	Max	V _{IN} = 0.5V
I _{OS}	Output Short-Circuit Current	-60		-150	mA	Max	V _{OUT} = 0V
I _{CCH}	Power Supply Current (F398)		25	38	mA	Max	V _O = HIGH
I _{CCL}	Power Supply Current (F398)		25	38	mA	Max	V _O = LOW
I _{CCH}	Power Supply Current (F399)		22	34	mA	Max	V _O = HIGH
I _{CCL}	Power Supply Current (F399)		22	34	mA	Max	V _O = LOW

AC Electrical Characteristics

Symbol	Parameter	74F			54F		74F		Units	
		T _A = +25°C V _{CC} = +5.0V C _L = 50 pF			T _A , V _{CC} = Mil C _L = 50 pF		T _A , V _{CC} = Com C _L = 50 pF			
		Min	Typ	Max	Min	Max	Min	Max		
f _{max}	Input Clock Frequency	100	140		80		100		MHz	
t _{PLH} t _{pHL}	Propagation Delay CP to Q or \bar{Q}	3.0*	5.7	7.5	3.0	9.5	3.0	8.5	10.0	ns

*F398 3.3 ns

AC Operating Requirements

Symbol	Parameter	74F		54F		74F		Units
		T _A = +25°C V _{CC} = +5.0V		T _A , V _{CC} = Mil		T _A , V _{CC} = Com		
		Min	Max	Min	Max	Min	Max	
t _s (H) t _s (L)	Setup Time, HIGH or LOW I _n to CP	3.0		4.5		3.0		ns
t _h (H) t _h (L)	Hold Time, HIGH or LOW I _n to CP	1.0		1.5		1.0		
t _s (H) t _s (L)	Setup Time, HIGH or LOW S to CP (*F398)	7.5		10.5		8.5		ns
t _s (H) t _s (L)	Setup Time, HIGH or LOW S to CP (*F399)	7.5		9.5		8.5		
t _h (H) t _h (L)	Hold Time, HIGH or LOW S to CP	0		0		0		ns
t _w (H) t _w (L)	CP Pulse Width HIGH or LOW	4.0		4.0		4.0		
		5.0		7.0		5.0		

Ordering Information

The device number is used to form part of a simplified purchasing code where the package type and temperature range are defined as follows:

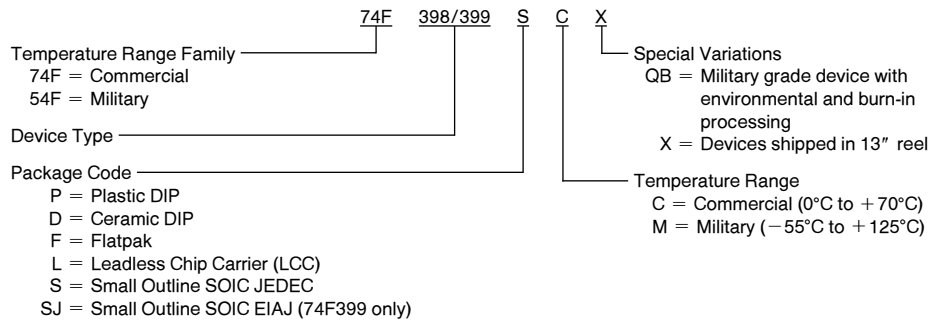

Physical Dimensions inches (millimeters)

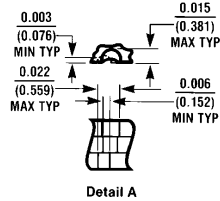
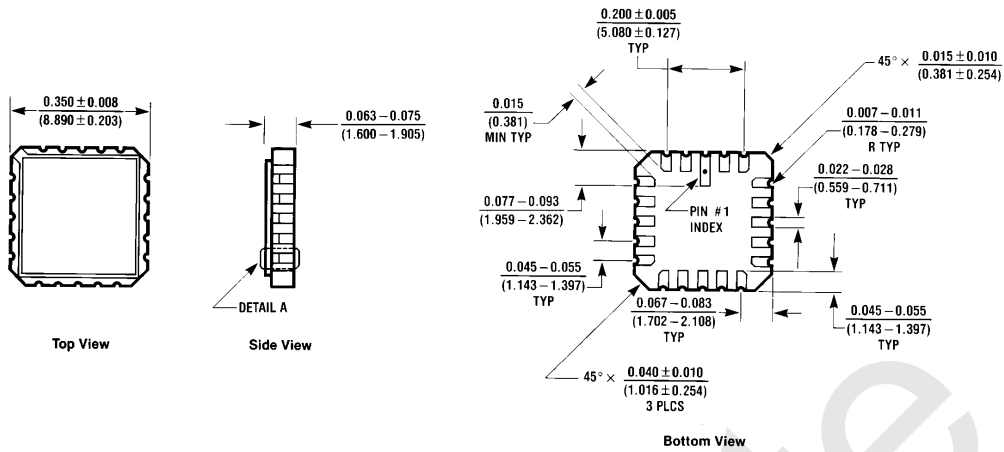

20-Lead Ceramic Leadless Chip Carrier (L)
 NS Package Number E20A

E20A (REV D)

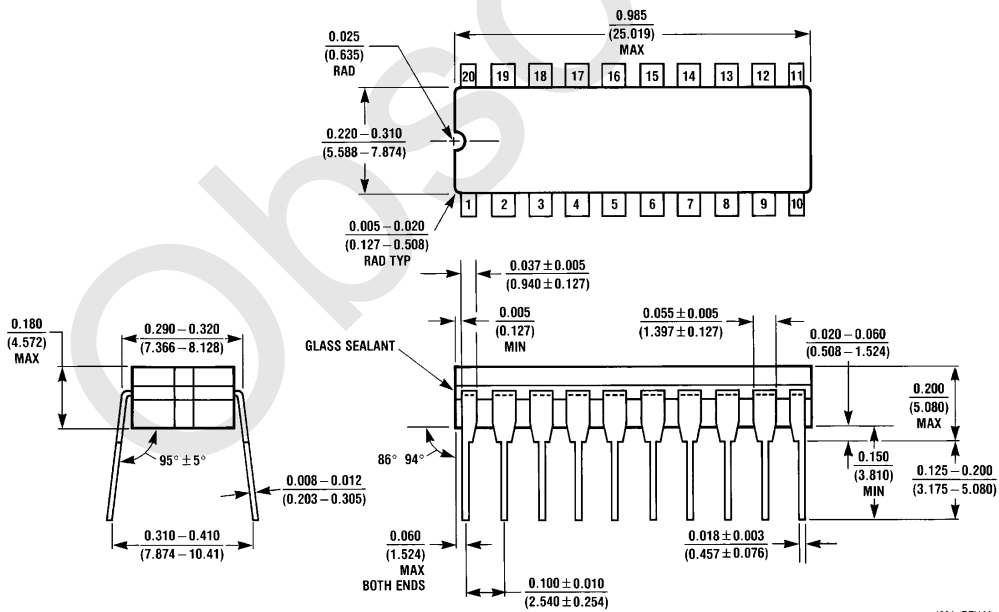

20-Lead Ceramic Dual-In-Line Package (D)
 NS Package Number J20A

J20A (REV M)

Physical Dimensions inches (millimeters) (Continued)

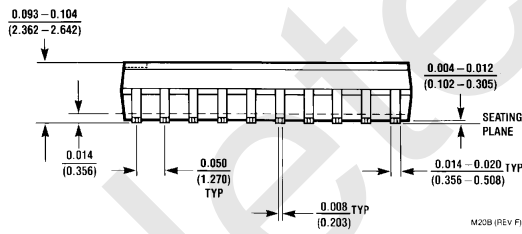
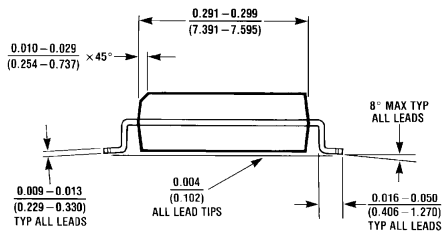
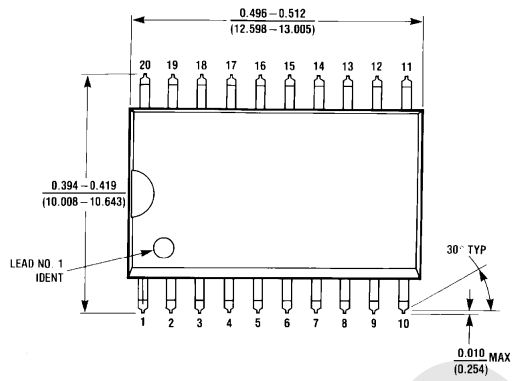

**20-Lead (0.300" Wide) Molded Small Outline Package, JEDEC (S)
NS Package Number M20B**

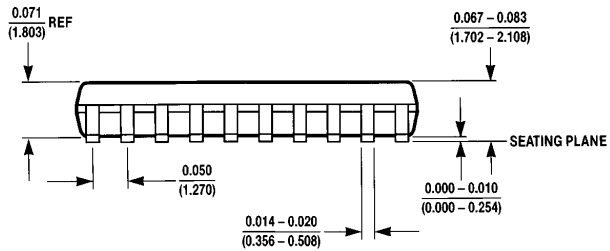
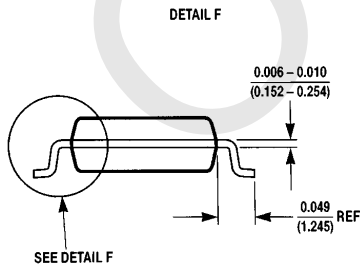
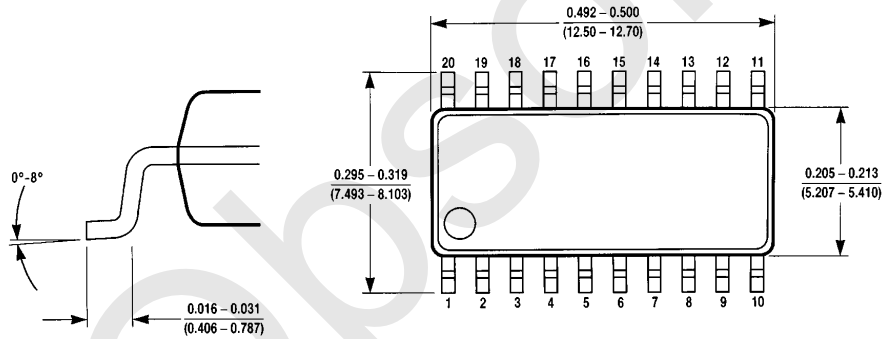

**20-Lead (0.300" Wide) Molded Small Outline Package, EIAJ (SJ)
NS Package Number M20D**

Physical Dimensions inches (millimeters) (Continued)

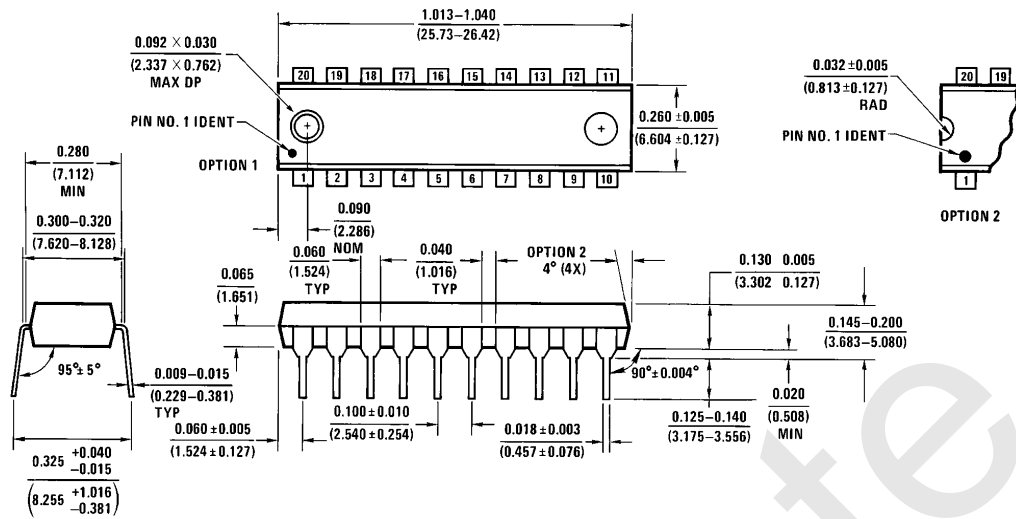

20-Lead (0.300" Wide) Molded Dual-In-Line Package (P)
NS Package Number N20A

N20A (REV G)

Physical Dimensions inches (millimeters) (Continued)

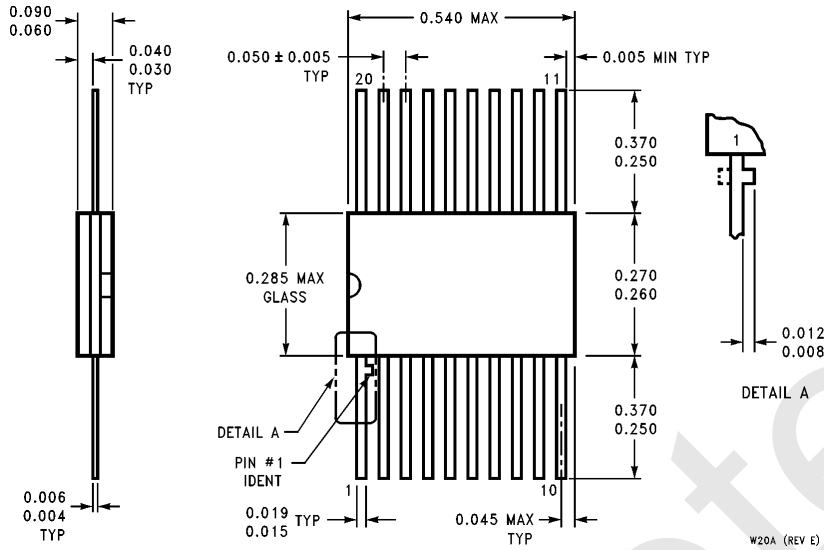

**20-Lead Ceramic Flatpak (F)
NS Package Number W20A**

W20A (REV E)

LIFE SUPPORT POLICY

NATIONAL'S PRODUCTS ARE NOT AUTHORIZED FOR USE AS CRITICAL COMPONENTS IN LIFE SUPPORT DEVICES OR SYSTEMS WITHOUT THE EXPRESS WRITTEN APPROVAL OF THE PRESIDENT OF NATIONAL SEMICONDUCTOR CORPORATION. As used herein:

1. Life support devices or systems are devices or systems which, (a) are intended for surgical implant into the body, or (b) support or sustain life, and whose failure to perform, when properly used in accordance with instructions for use provided in the labeling, can be reasonably expected to result in a significant injury to the user.
2. A critical component is any component of a life support device or system whose failure to perform can be reasonably expected to cause the failure of the life support device or system, or to affect its safety or effectiveness.



National Semiconductor Corporation
2900 Semiconductor Drive
P.O. Box 58090
Santa Clara, CA 95052-8090
Tel: 1(800) 272-9959
TWX: (910) 339-9240

National Semiconductor GmbH
Livry-Gargan-Str. 10
D-82256 Fürstenfeldbruck
Germany
Tel: (81-41) 35-0
Telex: 527849
Fax: (81-41) 35-1

National Semiconductor Japan Ltd.
Sumitomo Chemical
Engineering Center
Bldg. 7F
1-7-1, Nakase, Mihama-Ku
Chiba-City,
Ciba Prefecture 261
Tel: (043) 299-2300
Fax: (043) 299-2500

National Semiconductor Hong Kong Ltd.
13th Floor, Straight Block,
Ocean Centre, 5 Canton Rd.
Tsimshatsui, Kowloon
Hong Kong
Tel: (852) 2737-1600
Fax: (852) 2736-9960

National Semicondutores Do Brazil Ltda.
Rue Deputado Lacorda Franco
120-3A
Sao Paulo-SP
Brazil 05418-000
Tel: (55-11) 212-5066
Telex: 391-1131931 NSBR BR
Fax: (55-11) 212-1181

National Semiconductor (Australia) Pty. Ltd.
Building 16
Business Park Drive
Monash Business Park
Nottingham, Melbourne
Victoria 3168 Australia
Tel: (3) 558-9999
Fax: (3) 558-9998

National does not assume any responsibility for use of any circuitry described, no circuit patent licenses are implied and National reserves the right at any time without notice to change said circuitry and specifications.

IMPORTANT NOTICE

Texas Instruments Incorporated and its subsidiaries (TI) reserve the right to make corrections, modifications, enhancements, improvements, and other changes to its products and services at any time and to discontinue any product or service without notice. Customers should obtain the latest relevant information before placing orders and should verify that such information is current and complete. All products are sold subject to TI's terms and conditions of sale supplied at the time of order acknowledgment.

TI warrants performance of its hardware products to the specifications applicable at the time of sale in accordance with TI's standard warranty. Testing and other quality control techniques are used to the extent TI deems necessary to support this warranty. Except where mandated by government requirements, testing of all parameters of each product is not necessarily performed.

TI assumes no liability for applications assistance or customer product design. Customers are responsible for their products and applications using TI components. To minimize the risks associated with customer products and applications, customers should provide adequate design and operating safeguards.

TI does not warrant or represent that any license, either express or implied, is granted under any TI patent right, copyright, mask work right, or other TI intellectual property right relating to any combination, machine, or process in which TI products or services are used. Information published by TI regarding third-party products or services does not constitute a license from TI to use such products or services or a warranty or endorsement thereof. Use of such information may require a license from a third party under the patents or other intellectual property of the third party, or a license from TI under the patents or other intellectual property of TI.

Reproduction of TI information in TI data books or data sheets is permissible only if reproduction is without alteration and is accompanied by all associated warranties, conditions, limitations, and notices. Reproduction of this information with alteration is an unfair and deceptive business practice. TI is not responsible or liable for such altered documentation. Information of third parties may be subject to additional restrictions.

Resale of TI products or services with statements different from or beyond the parameters stated by TI for that product or service voids all express and any implied warranties for the associated TI product or service and is an unfair and deceptive business practice. TI is not responsible or liable for any such statements.

TI products are not authorized for use in safety-critical applications (such as life support) where a failure of the TI product would reasonably be expected to cause severe personal injury or death, unless officers of the parties have executed an agreement specifically governing such use. Buyers represent that they have all necessary expertise in the safety and regulatory ramifications of their applications, and acknowledge and agree that they are solely responsible for all legal, regulatory and safety-related requirements concerning their products and any use of TI products in such safety-critical applications, notwithstanding any applications-related information or support that may be provided by TI. Further, Buyers must fully indemnify TI and its representatives against any damages arising out of the use of TI products in such safety-critical applications.

TI products are neither designed nor intended for use in military/aerospace applications or environments unless the TI products are specifically designated by TI as military-grade or "enhanced plastic." Only products designated by TI as military-grade meet military specifications. Buyers acknowledge and agree that any such use of TI products which TI has not designated as military-grade is solely at the Buyer's risk, and that they are solely responsible for compliance with all legal and regulatory requirements in connection with such use.

TI products are neither designed nor intended for use in automotive applications or environments unless the specific TI products are designated by TI as compliant with ISO/TS 16949 requirements. Buyers acknowledge and agree that, if they use any non-designated products in automotive applications, TI will not be responsible for any failure to meet such requirements.

Following are URLs where you can obtain information on other Texas Instruments products and application solutions:

Products

Audio	www.ti.com/audio
Amplifiers	amplifier.ti.com
Data Converters	dataconverter.ti.com
DLP® Products	www.dlp.com
DSP	dsp.ti.com
Clocks and Timers	www.ti.com/clocks
Interface	interface.ti.com
Logic	logic.ti.com
Power Mgmt	power.ti.com
Microcontrollers	microcontroller.ti.com
RFID	www.ti-rfid.com
OMAP Mobile Processors	www.ti.com/omap
Wireless Connectivity	www.ti.com/wirelessconnectivity

Applications

Communications and Telecom	www.ti.com/communications
Computers and Peripherals	www.ti.com/computers
Consumer Electronics	www.ti.com/consumer-apps
Energy and Lighting	www.ti.com/energy
Industrial	www.ti.com/industrial
Medical	www.ti.com/medical
Security	www.ti.com/security
Space, Avionics and Defense	www.ti.com/space-avionics-defense
Transportation and Automotive	www.ti.com/automotive
Video and Imaging	www.ti.com/video

TI E2E Community Home Page

e2e.ti.com

Mailing Address: Texas Instruments, Post Office Box 655303, Dallas, Texas 75265
Copyright © 2011, Texas Instruments Incorporated