

CLC5509

CLC5509 Ultra Low Noise Preamplifier



Literature Number: SNOS513C

CLC5509 Ultra Low Noise Preamplifier

General Description

The CLC5509 is a high performance, ultra low noise preamplifier designed for applications requiring unconditional stability for wide ranges of complex input loads. Both input impedance and gain are externally adjustable, which make it simple to interface to peizoelectric ultrasound transducers. The CLC5509 preamplifier's low $0.58nV/\sqrt{Hz}$ total input noise makes it ideal for noise sensitive front ends. The high repeatability in group delay over voltage and temperature translates into precision edge measurements for Doppler applications.

The IC consists of an emitter input, common base amplifier stage followed by a low distortion, closed loop buffer. The Noise Figure can be user programmed by controlling the emitter current (I_{BIAS1}) which sets emitter resistance r_e . External negative feedback creates a well controlled input impedance to allow a near noiseless active input transmission line termination. The preamp is stable against changes in source impedance of 50 to 200Ω over temperature and supply variations, with gains from 14dB to 26dB. The CLC5509 preamp architecture is also well suited for use with magneto-resistive tape or disk drive heads. In these applications the head bias current can be reused to bias the preamp. The part is packaged in an 8-pin plastic SOIC, and runs off ±5V supplies. External biasing is required for the input signal path.

The CLC5509 is constructed using an advanced complementary bipolar process and National Semiconductor's proven high performance architectures.

Features

- $0.58nV/\sqrt{Hz}$ total input noise @ 12MHz
- >3.0dB Noise figure advantage over shunt termination
- <.5ns group delay repeatability
- High cutoff -3dB @ 33MHz
- Low cutoff -3dB @ 0.5MHz
- 2.0dB noise figure @ 50Ω
- -60dBc intermod for $2V_{PP}$ @ 5MHz
- Programmable noise figure vs. I_{BIAS1}
- Supply current: 11mA
- Available in 8-pin SOIC

Applications

- Ultrasound preamp
- Tape drive preamp
- Disk drive preamp

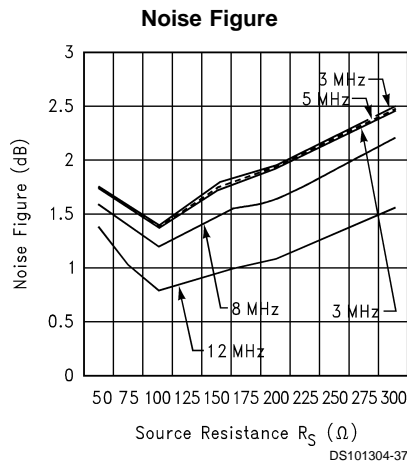

Connection Diagram

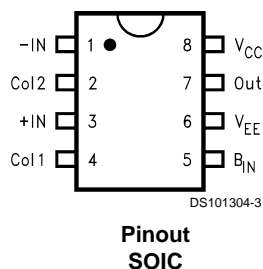

Typical Application

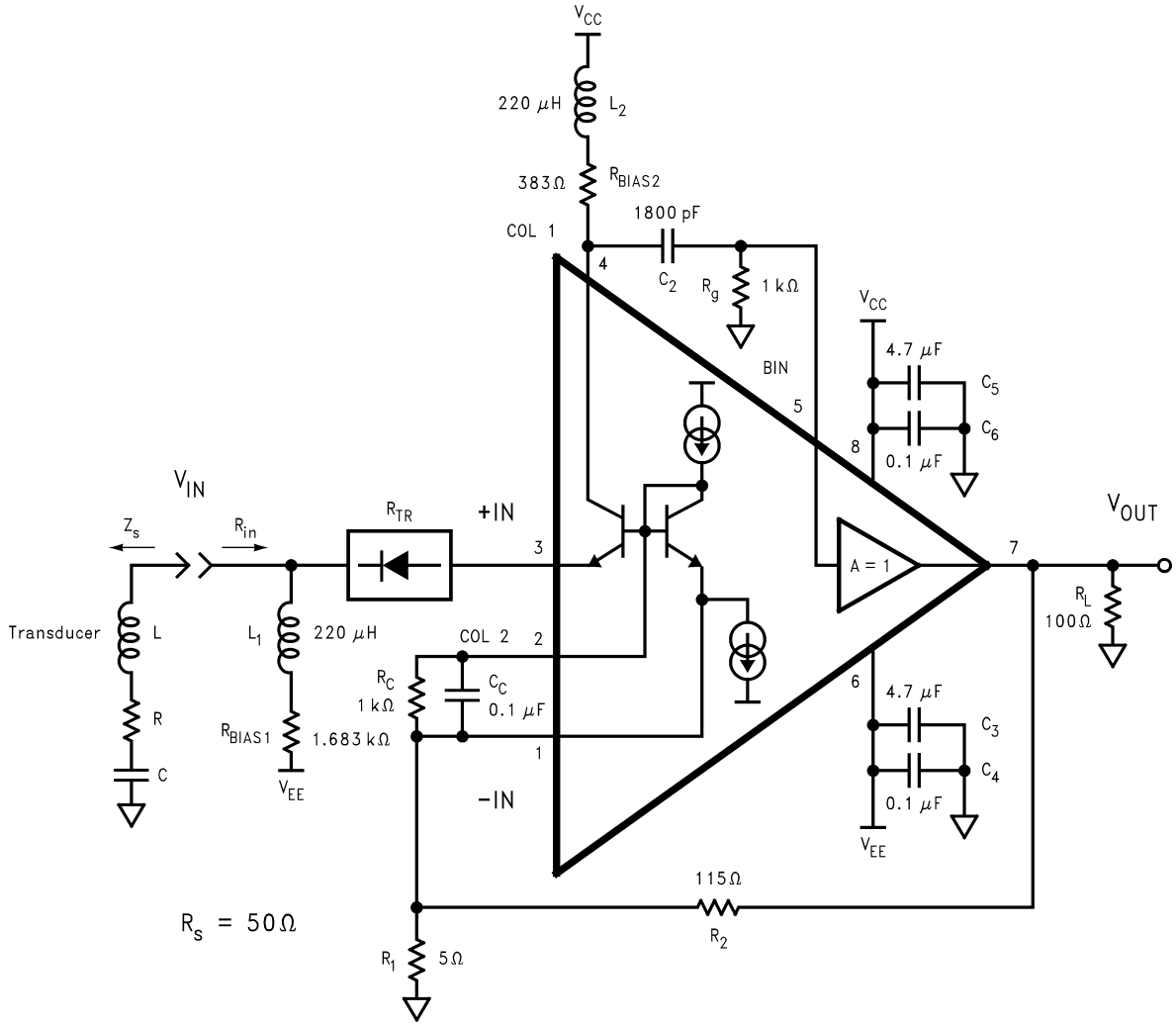

DS101304-2

Ultrasound PreAmp

Ordering Information

Package	Temperature Range Industrial	Part Number	Package Marking	Transport Media	NSC Drawing
8-pin SOIC	0°C to 70°C	CLC5509CM	CLC5509CM	Rails	M08A
		CLC5509CMX	CLC5509CM	2.5k Tape and Reel	

Absolute Maximum Ratings (Note 1)

If Military/Aerospace specified devices are required, please contact the National Semiconductor Sales Office/Distributors for availability and specifications.

Supply Voltage $\pm 5.5V$
Output Current 70mA

Common-Mode Input Voltage $\pm V_{CC}$
Maximum Junction Temperature $+150^{\circ}C$
Storage Temperature Range $-65^{\circ}C$ to $+150^{\circ}C$
Lead Temperature (soldering 10 sec) $+300^{\circ}C$
ESD Rating (human body model) 4000V

Electrical Characteristics (Note 3)

(V_{CC} , $V_{EE} = \pm 5V$, $R_S = 50\Omega$, $A_V = 10V/V$, $R_g = 1k\Omega$, $R_L = 100\Omega$; unless specified)

Symbol	Parameter	Conditions	Typ	Min/Max Ratings (Note 2)	Units
	Ambient Temperature	CLC5509	$+25^{\circ}C$	$+25^{\circ}C$	
Frequency Domain Response					
	-3dB Bandwidth	$V_O < 2.0V_{PP}$			
	High Cutoff	-3dB	33	28 45	MHz
	Low Cutoff	-3dB	0.5	0.4 0.7	MHz
	Gain Flatness Inband	$2 < 12.5MHz$, $V_O < 1.0V_{PP}$	-1.5 +1		dB
	Gain Accuracy @ 5MHz			± 0.3	dB
	Phase Variation	$3 < 9MHz$, $V_O < .1V_{PP}$	1		Deg
	Gain Variation	$3 < 9MHz$, $V_O < .1V_{PP}$	0.3		dB
Time Domain Response					
	Rise and Fall Time	2V step	10	10 15	ns
	Settling Time to 0.2%	2V step	1		μs
	Overshoot	2V step	0	5	%
	Group Delay	$2.5MHz < 10MHz$, $V_{IN} = 10mV_{PP}$	5.5	3 7.5	ns
	Group Delay Repeatability		0.5		ns
Distortion And Noise Response					
	2nd Harmonic Distortion	$< 12.5MHz$, $V_{IN} = 100mV_{PP}$	-51		dBc
	3rd Harmonic Distortion		-56		dBc
	Intermodulation Distortion	@ 5MHz	-65		dBc
	Equivalent Input Noise Voltage (e_{ni})	$> 1MHz$, $R_S = 50\Omega$ $12MHz$, $R_S = 50\Omega$	0.7 0.58	0.78	$nV\sqrt{Hz}$
	Noise Figure	@ 50Ω	2	2.4	dB
	Optimum R_S		85	80 110	Ω
Static, DC Performance					
	PSRR (preamp only)	$< 1MHz$	40		dB
	Supply Current (preamp only)	$R_L = \infty$	9	11	mA
Miscellaneous Performance					
	Output Impedance	DC $< 12MHz$	0.2	0.2 1	Ω
	Output Voltage Range	$R_L = 100\Omega$	± 2	± 1.7	V
	Output Current		± 45	± 35	mA

Electrical Characteristics (Note 3) (Continued)

Note 1: "Absolute Maximum Ratings" are those values beyond which the safety of the device cannot be guaranteed. They are not meant to imply that the devices should be operated at these limits. The table of "Electrical Characteristics" specifies conditions of device operation.

Note 2: Min/max ratings are based on product characterization and simulation. Individual parameters are tested as noted. Outgoing quality levels are determined from tested parameters.

Note 3: All data taken in circuit shown as typical application.

Typical Performance Characteristics

Frequency Response

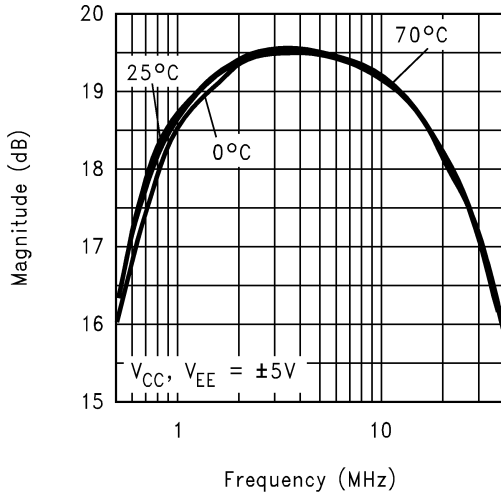

Frequency Response

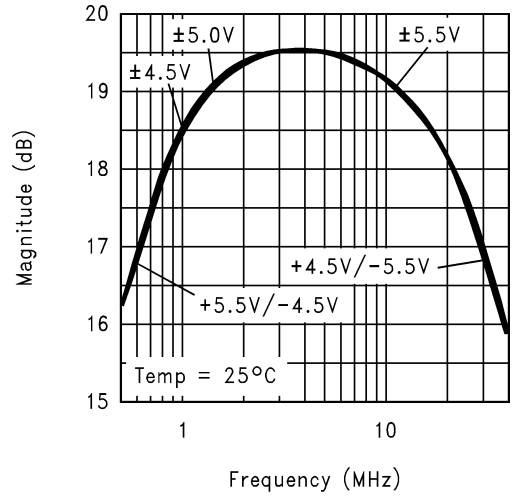

Frequency Response

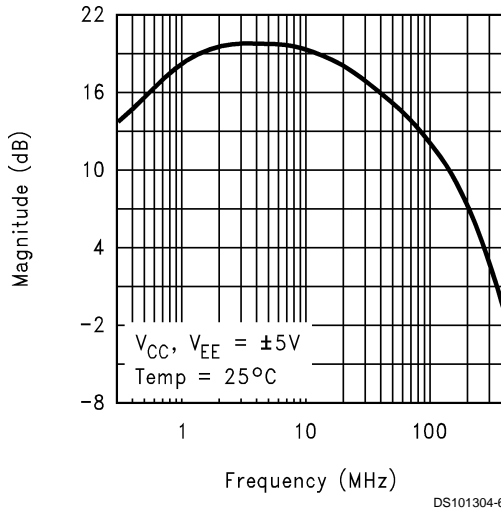

Group Delay

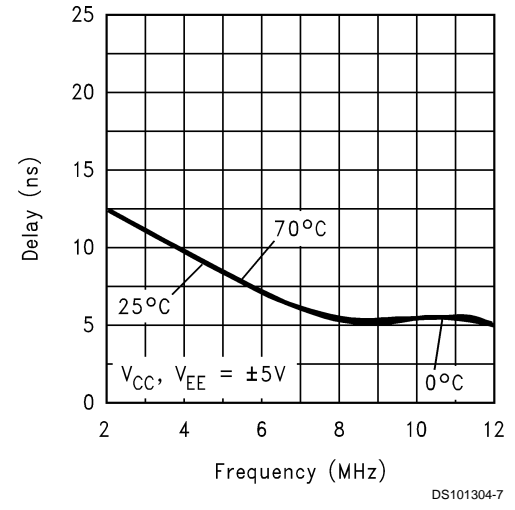

Typical Performance Characteristics (Continued)

Group Delay

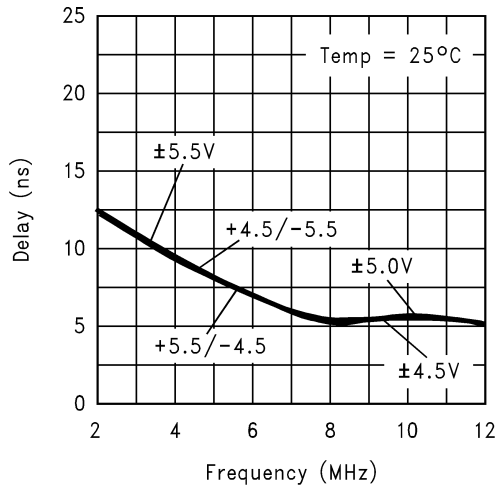

Group Delay Repeatability

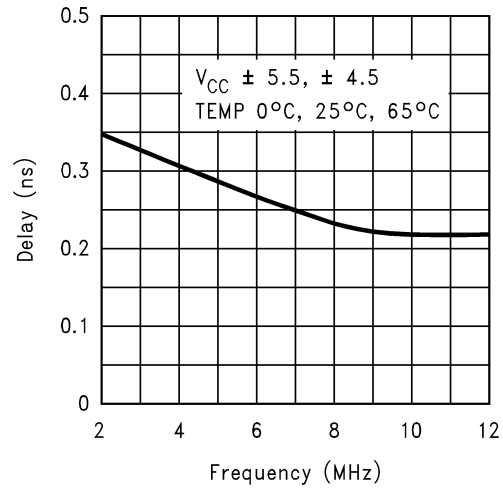

3rd Harmonic Distortion

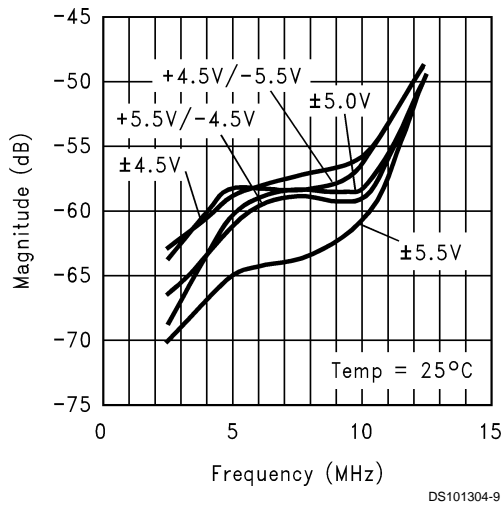

3rd Harmonic Distortion

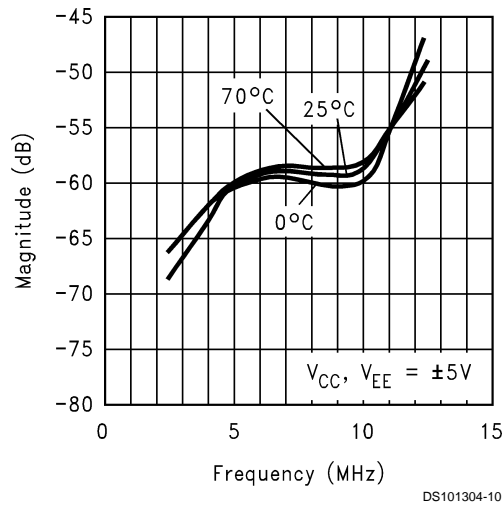

2nd Harmonic Distortion

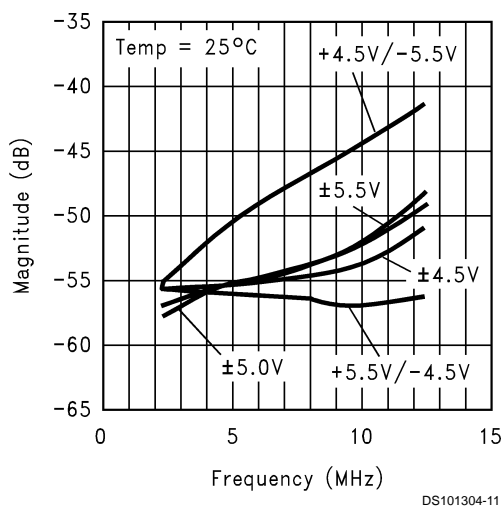

2nd Harmonic Distortion

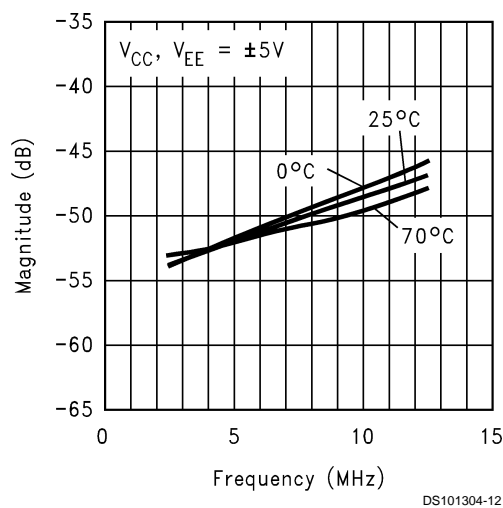

Typical Performance Characteristics (Continued)

Intermodulation Distortion

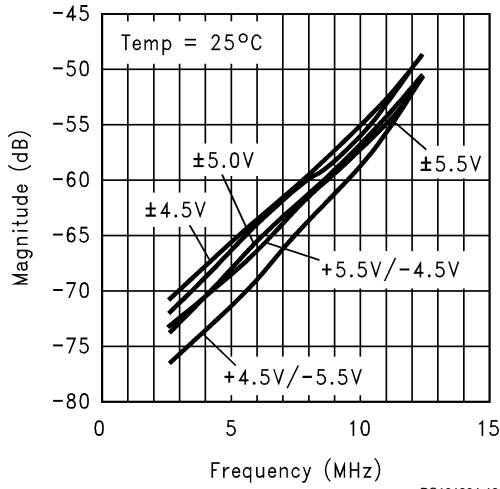

Intermodulation Distortion

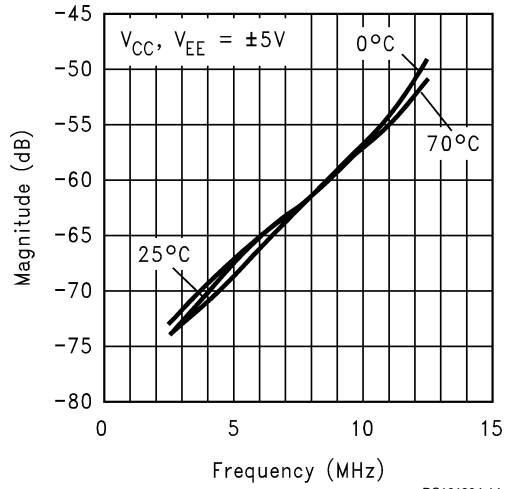

Total Input Referred Noise ($R_S = 50\Omega$)

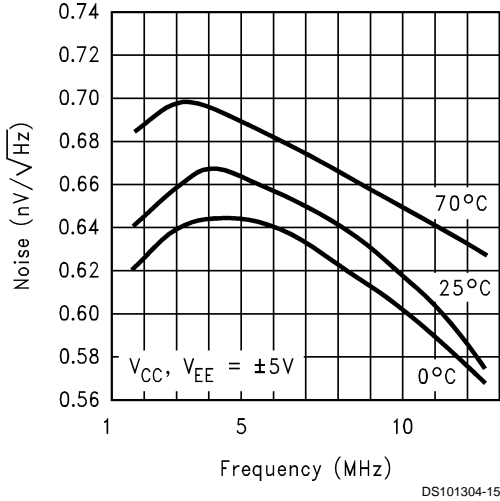

Total Input Referred Noise ($R_S = 50\Omega$)

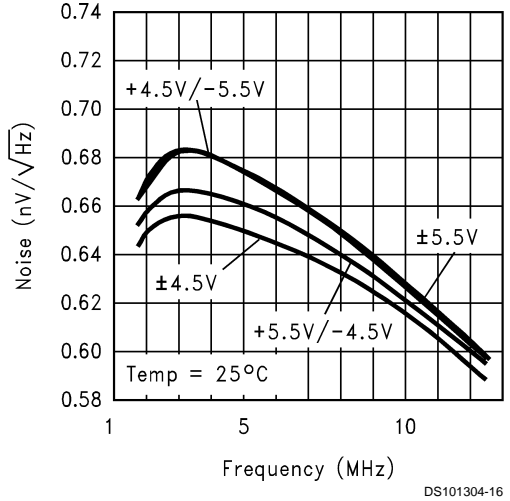

Total Input Referred Noise ($R_S = 100\Omega$)

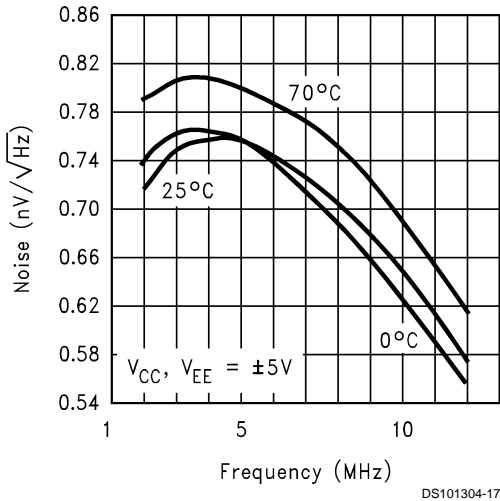

Total Input Referred Noise ($R_S = 100\Omega$)

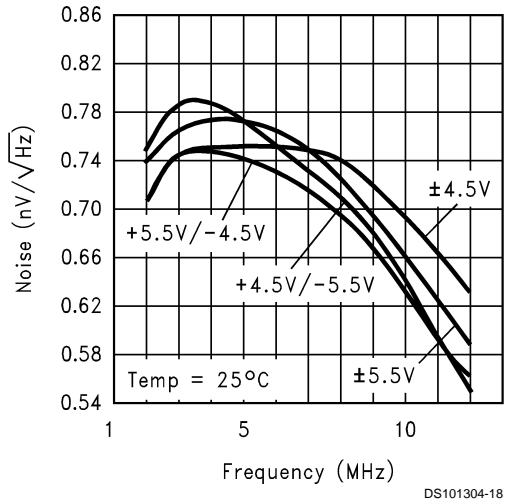

Typical Performance Characteristics (Continued)

Total Input Referred Noise ($R_S = 200\Omega$)

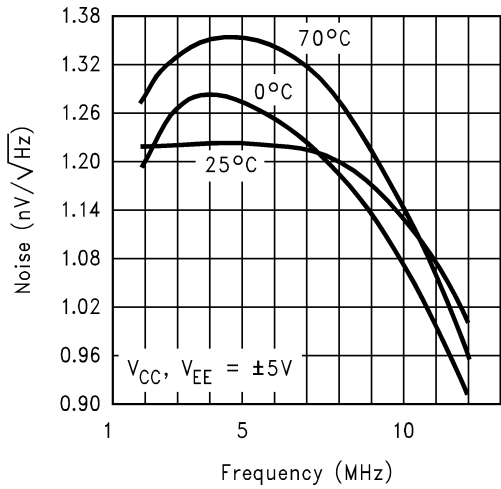

Total Input Referred Noise ($R_S = 200\Omega$)

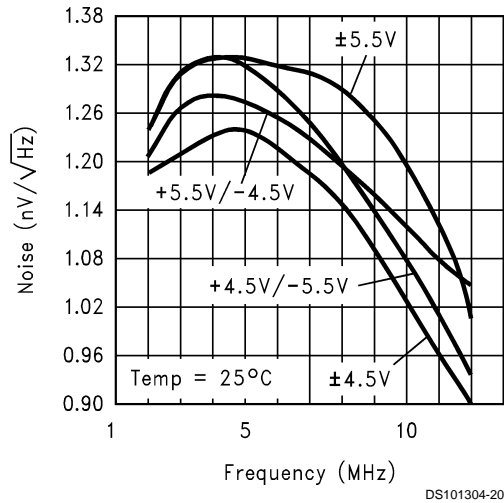

Z_{in}

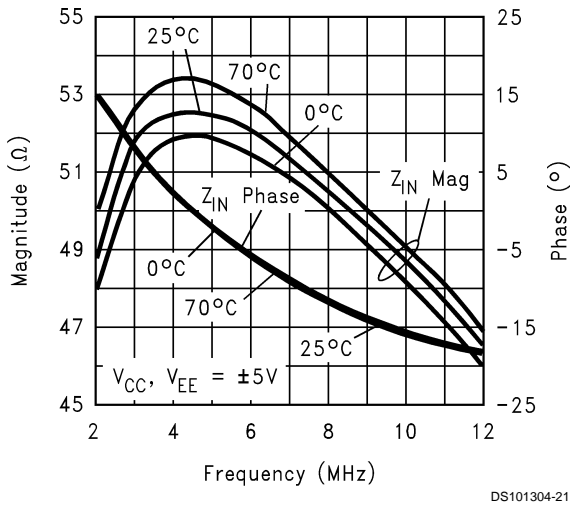

Z_{in}

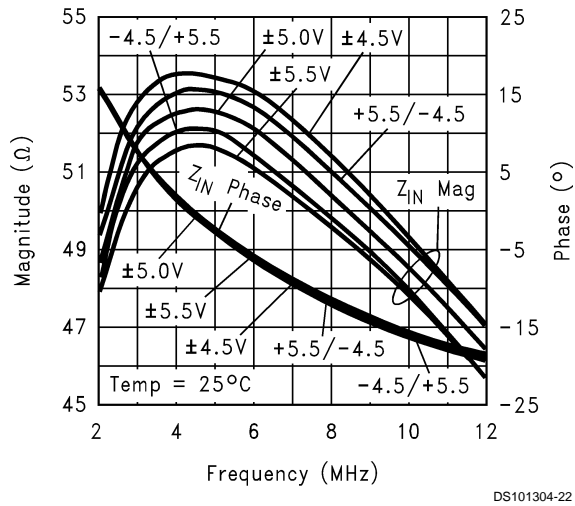

Z_o

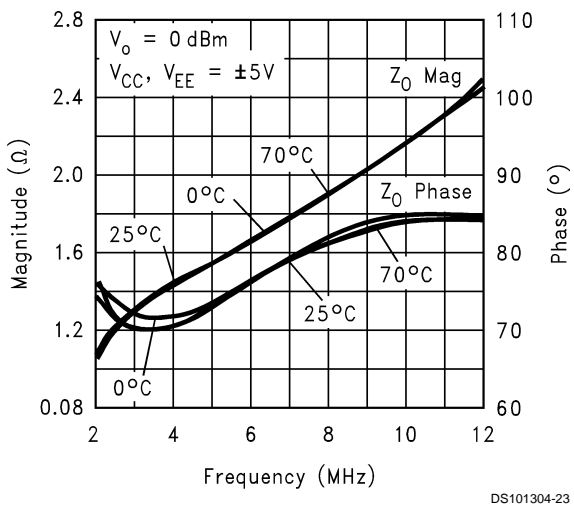

Z_o

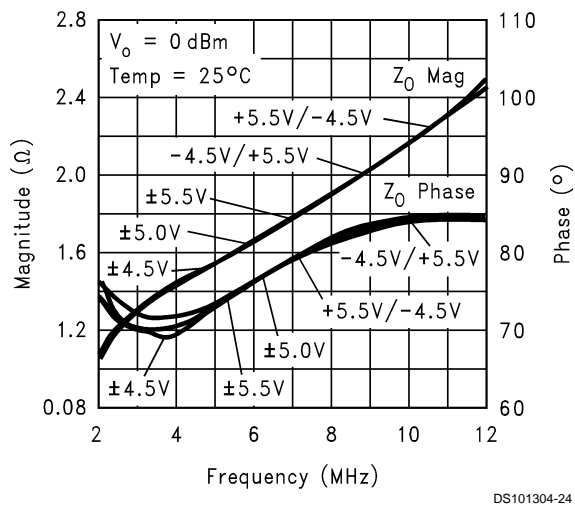

Typical Performance Characteristics (Continued)

Positive PSRR (V_{CC})

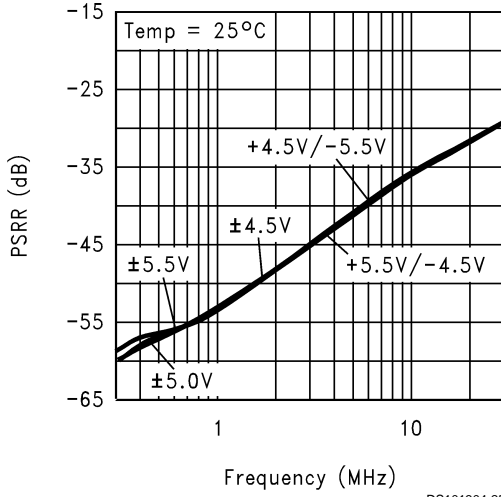

Positive PSRR (V_{CC})

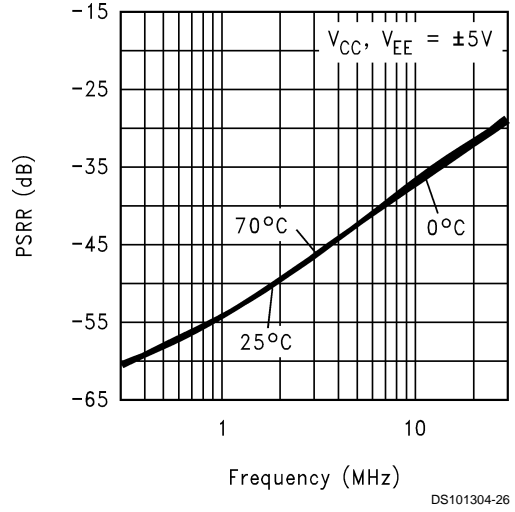

Negative PSRR (V_{EE})

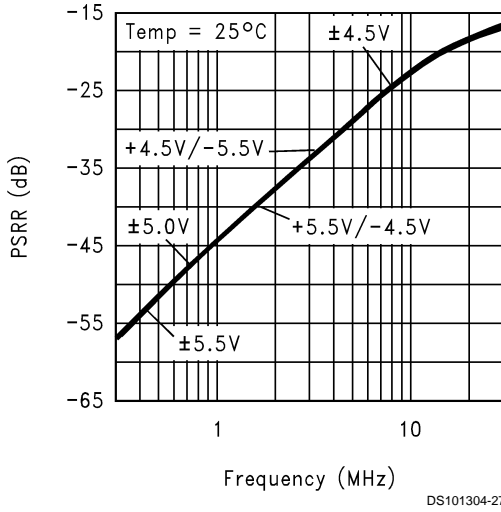

Negative PSRR (V_{EE})

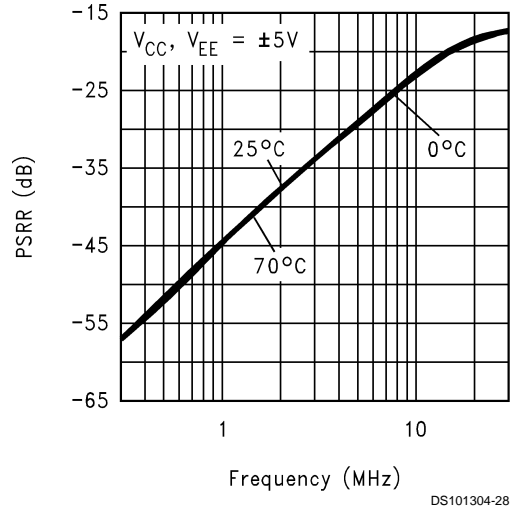

Application Information

Introduction

The CLC5509 is a two stage ultra-low noise preamplifier, with low distortion, and externally variable input impedance. The unusual emitter driven input stage remains stable for a wide range of transducer source loads. The input termination can be matched (for 50-200Ω source matching) to a wide range of complex loads (C_S up to 5000pF and C_P up to 10000pF, L_S up to 1μH). The IC was designed for low cost multiple channel ultrasound applications requiring flexible configurations for a variety of transmit/receive topologies. In a typical application, the CLC5509 is connected to a single element of an ultrasound transducer through a transmit/receive switch.

Theory of Operation

The CLC5509 simplified circuit is shown in *Figure 1*. For analysis, the transmit/receive switch diode is modeled in the circuit as a series resistance R_{TR} with a voltage drop of V_{RT} . A piezo transducer generated, single-ended, positive voltage signal is applied to the emitter input of the 1st stage. The voltage signal is converted to a current (i) that is passed through a high pass filter then restored back to a voltage signal at R_g . A high speed, low distortion, unity gain buffer, applies the signal to the load and feedback resistor. Negative feedback from the buffer output to the inverting input completes the signal path.

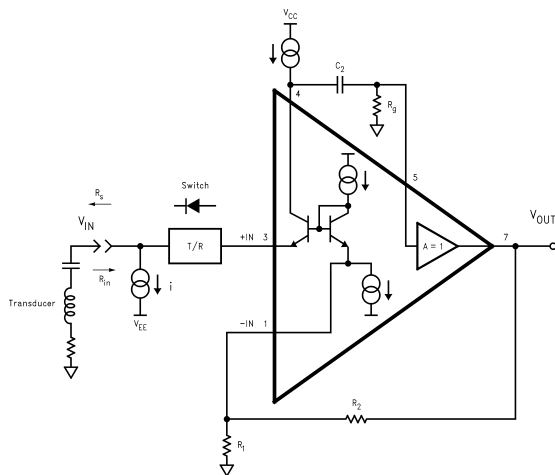

DS101304-29

FIGURE 1. Simplified Circuit

The input and output voltage can be expressed as shown:

$$V_{IN} = (R_{TR} + r_e) i + V_O (R_1 / (R_1 + R_2))$$

$$V_O = -(i \times R_g) \quad \text{for } \alpha = 1$$

The input resistance is calculated

$$R_{IN} = \frac{V_{IN}}{I_i} = R_{TR} + r_e + R_g (R_1 / (R_1 + R_2))$$

The current I_{BIAS1} is the input stage emitter current that sets r_e .

$$I_{BIAS1} = (V_{EE} - V_{TR}) / R_{BIAS1} \quad \text{for } V_{EE} = V_{TR} = .65V$$

$$r_e = 26mV / I_{BIAS1}$$

Combining terms, then solving for close loop gain V_O / V_{in} results in

$$A_{CL} \approx \frac{R_g}{R_{IN}}$$

Choosing External Component Values

There are three key parameters to consider in the design: Noise, signal bandwidth, and gain. Refer to *Figure 2*.

The best noise performance for a given transmit/receive switch R_{TR} is obtained by: choosing R_S between 50Ω and 200Ω; selecting the matching termination resistance R_{in} ; and by reducing I_{BIAS1} (by increasing R_{BIAS1}) to increase r_e which optimizes the Noise Figure (NF). For this circuit, with $R_{TR} = 6\Omega$, the optimum NF is achieved at $R_S \sim 95\Omega$ when R_{in} is set to 50Ω and $R_S \sim 145\Omega$ when R_{in} is set to 200Ω.

The signal bandwidth is determined by the selection of L_1 , L_2 , R_{BIAS1} and R_{BIAS2} which set the open loop gain roll-off of the first stage. R_g and C_2 form a desirable signal path filter that introduces an additional highpass pole. The filter values can be chosen to create a sharper high frequency roll off of the closed loop gain. For $R_g = 1k$, $C_2 \sim 470pF$ the small signal ($V_{in} < 25mV$), wide bandwidth performance can be observed. By increasing C_2 (to $> 1500pF$) and increasing output series resistance with a small resistor, the stability and harmonic distortion performance can be improved for large signals. This filter can also be designed as a multi-pole Butterworth filter but care must be taken to ensure stability with the desired load over the operating temperature range.

The passband gain is customer selected by setting R_g and R_{in} . Note that using R_1 to reduce or increase the gain allows for minimal interaction with other parameters.

Capacitor C_C and resistor R_C are used for local compensation of the gm input stage with values of $C_C = 0.1\mu F$ and $R_C = 1k$ for the applications described below.

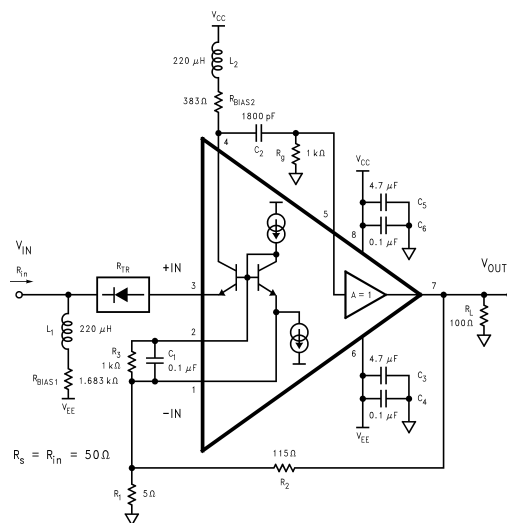

DS101304-32

FIGURE 2. Complete Circuit

Calculating and Measuring the Noise

The circuit input referred noise is best calculated using a SPICE model where the external components can be optimized for the transducer source impedance and transmit/receive switch impedance. The SPICE model for the CLC5509 is available on the NSC web site. Refer to the figures for total noise performance over temperature and

Application Information (Continued)

supply at 3mA. Once the noise is modeled and circuit parameters chosen the evaluation board can be used to measure actual noise performance.

To measure the CLC5509 input referred noise vs. other noise sources, several key steps should be followed. The bench setup is fairly simple using the evaluation board and a spectrum analyzer. (If a noise figure meter is available that is even easier yet.) The procedure requires calibrating out the spectrum analyzer background noise, and other noise sources from the CLC5509 noise. Since the thermal noise of a resistor is well known, add a series resistor R_4 between the signal source V_{in} and the L_1 , R_{BIAS1} bias network for these noise measurements. Several R_4 resistor values are used as "reference" noise sources. The values chosen depend on the R_{in} of the system. For $R_{in} = 50\Omega$, resistor (R_4) with values of 0, 12.5, 25, 50 Ω should be used. If $R_{in} = 200\Omega$, resistors (R_4) with values of 0, 25, 50, 100, 200 Ω should be used. Start by connecting the analyzer input to the evaluation board output. Remove R_4 from the signal source and connect R_4 to GND. Now take at least 10 measurements and average them for each R_4 reference value. Be sure to divide the result by the analyzer and circuit gain to make the noise power input referred. Subtract the $R_4 = 0\Omega$ results from the data for each value using an RMS difference. Compare the result to the theoretical noise values. They should agree closely over the $R_4 = 0$ to R_{in} range. This verifies the test method. The CLC5509 noise is the $R_4 = 0\Omega$ data point.

The optimum R_S value for best noise figure can be adjusted from $R_S \sim 80$ to $R_S \sim 120\Omega$ by changing I_{BIAS1} from 12mA to 3mA. The I_{BIAS1} current could be made programmable to optimize the NF for different transducer source impedances. A similar procedure can be used to remove the T/R switch noise by varying the T/R bias current I_{BIAS1} . The total circuit noise performance can now be optimized for R_{in} as described above.

Evaluation Board

Evaluation boards are available for customer product evaluation for the 8-pin SOIC. Evaluation kits that contain an

The CLC5509 system dynamic range performance is enhanced by using the CLC5523 variable gain amplifier as a post amplifier. See *Figure 4* below.

The signal gain range is divided between the CLC5509 preamplifier and the post amplifier to allow wider dynamic range and better performance for high crest factor signals. There are two common ways the CLC5523 variable gain could be controlled. The first, *Figure 5*, uses a DAC to digitally increase the gain in discrete steps. The second *Figure 6* uses an AGC loop to maintain the maximum system input signal-to-noise. Refer to the CLC5523 data sheet applications for the implementation details.

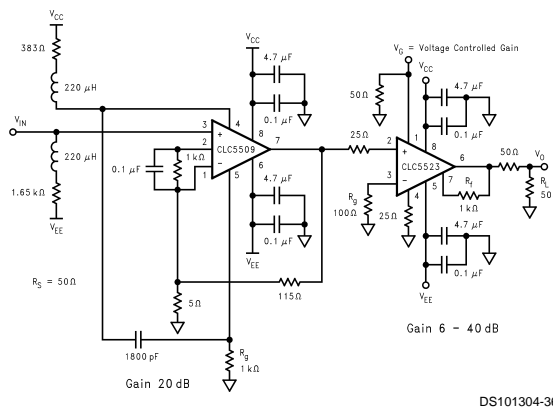

FIGURE 4. Low Noise Pre Amp with Variable Gain Amplifier Circuit

evaluation board and CLC5509 samples can be obtained by calling **National Semiconductor's Customer Service Center**. The evaluation kit number is CLC730101. The evaluation board utilizes surface mount components. The corner frequencies are set to $\sim 0.9\text{MHz}$ to 12.5MHz with a passband gain set at 20dB. The highpass filter is set at $R_g = 1\text{k}$, $C_2 = 470\text{pF}$ to view small signal ($V_{in} < 25\text{mV}$) performance. Increasing C_4 (to $> 1500\text{pF}$) reduces the bandwidth and improves distortion for large signals. R_g is a back match resistor that terminates the output and isolates cable capacitance, for minimum distortion, over the frequency band of interest. An $R_{in} \sim 50.2\Omega$ was chosen for $R_s = 50\Omega$ (this source resistor R_s is open) and $R_{TR} = 0$, with I_{BIAS1} set to 3mA. The expected input referred noise based on bench measurements on similar boards is $\sim 0.6\text{nV}/\sqrt{\text{Hz}}$ or a NF of 2dB. The noise can be optimized with slight variations in R_2 , R_g and R_{BIAS1} . If transmit/receive switches are added to the evaluation board both the voltage drop and R_{TR} should be compensated for. The R_{in} , gain and noise will be affected by the addition of the T/R switch. The V_{TR} drop can be removed, to a first order, by adding a second switch in series with the feedback gain setting resistor R_1 to ground. This will restore the input DC level to $\sim 0\text{V}$. This T/R switch diode should be biased with a resistor ($\sim R_{BIAS2}$) to V_{CC} and bypassed with a $0.1\mu\text{F}$ cap to maintain the same AC performance as the evaluation board without the switches.

CLC5509 Applications

The signal path for a typical ultrasound transceiver is shown in *Figure 3*.

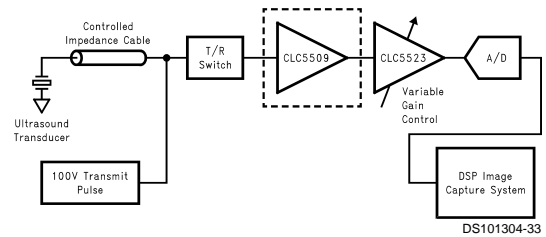

FIGURE 3.

Application Information (Continued)

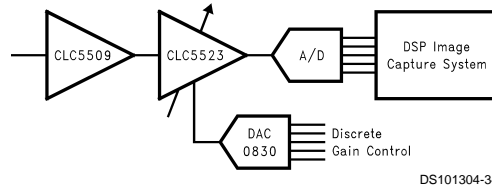

FIGURE 5. V_G Controlled by DAC in Discrete Steps

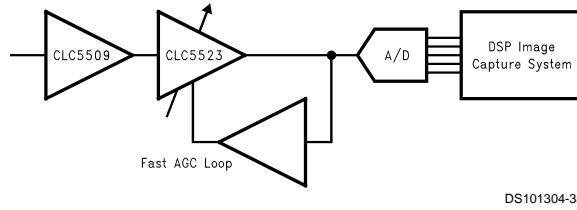
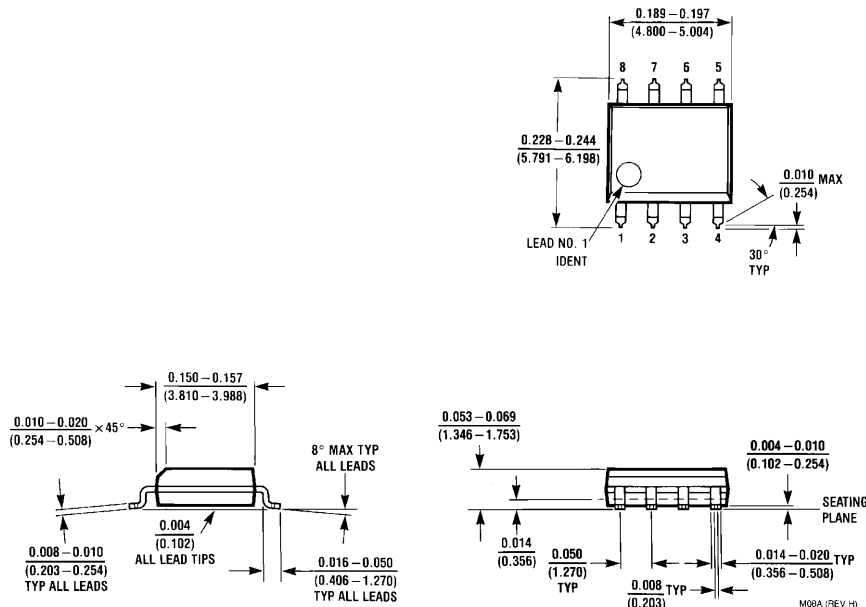

FIGURE 6. V_G Controlled by AGC Loop

Physical Dimensions inches (millimeters) unless otherwise noted



**8-pin SOIC
NS Package Number M08A**

LIFE SUPPORT POLICY

NATIONAL'S PRODUCTS ARE NOT AUTHORIZED FOR USE AS CRITICAL COMPONENTS IN LIFE SUPPORT DEVICES OR SYSTEMS WITHOUT THE EXPRESS WRITTEN APPROVAL OF THE PRESIDENT AND GENERAL COUNSEL OF NATIONAL SEMICONDUCTOR CORPORATION. As used herein:

1. Life support devices or systems are devices or systems which, (a) are intended for surgical implant into the body, or (b) support or sustain life, and whose failure to perform when properly used in accordance with instructions for use provided in the labeling, can be reasonably expected to result in a significant injury to the user.
2. A critical component is any component of a life support device or system whose failure to perform can be reasonably expected to cause the failure of the life support device or system, or to affect its safety or effectiveness.



National Semiconductor Corporation
Americas
Tel: 1-800-272-9959
Fax: 1-800-737-7018
Email: support@nsc.com
www.national.com

National Semiconductor Europe
Fax: +49 (0) 180-530 85 86
Email: europe.support@nsc.com
Deutsch Tel: +49 (0) 69 9508 6208
English Tel: +44 (0) 870 24 0 2171
Français Tel: +33 (0) 1 41 91 8790

National Semiconductor Asia Pacific Customer Response Group
Tel: 65-2544466
Fax: 65-2504466
Email: ap.support@nsc.com

National Semiconductor Japan Ltd.
Tel: 81-3-5639-7560
Fax: 81-3-5639-7507

IMPORTANT NOTICE

Texas Instruments Incorporated and its subsidiaries (TI) reserve the right to make corrections, modifications, enhancements, improvements, and other changes to its products and services at any time and to discontinue any product or service without notice. Customers should obtain the latest relevant information before placing orders and should verify that such information is current and complete. All products are sold subject to TI's terms and conditions of sale supplied at the time of order acknowledgment.

TI warrants performance of its hardware products to the specifications applicable at the time of sale in accordance with TI's standard warranty. Testing and other quality control techniques are used to the extent TI deems necessary to support this warranty. Except where mandated by government requirements, testing of all parameters of each product is not necessarily performed.

TI assumes no liability for applications assistance or customer product design. Customers are responsible for their products and applications using TI components. To minimize the risks associated with customer products and applications, customers should provide adequate design and operating safeguards.

TI does not warrant or represent that any license, either express or implied, is granted under any TI patent right, copyright, mask work right, or other TI intellectual property right relating to any combination, machine, or process in which TI products or services are used. Information published by TI regarding third-party products or services does not constitute a license from TI to use such products or services or a warranty or endorsement thereof. Use of such information may require a license from a third party under the patents or other intellectual property of the third party, or a license from TI under the patents or other intellectual property of TI.

Reproduction of TI information in TI data books or data sheets is permissible only if reproduction is without alteration and is accompanied by all associated warranties, conditions, limitations, and notices. Reproduction of this information with alteration is an unfair and deceptive business practice. TI is not responsible or liable for such altered documentation. Information of third parties may be subject to additional restrictions.

Resale of TI products or services with statements different from or beyond the parameters stated by TI for that product or service voids all express and any implied warranties for the associated TI product or service and is an unfair and deceptive business practice. TI is not responsible or liable for any such statements.

TI products are not authorized for use in safety-critical applications (such as life support) where a failure of the TI product would reasonably be expected to cause severe personal injury or death, unless officers of the parties have executed an agreement specifically governing such use. Buyers represent that they have all necessary expertise in the safety and regulatory ramifications of their applications, and acknowledge and agree that they are solely responsible for all legal, regulatory and safety-related requirements concerning their products and any use of TI products in such safety-critical applications, notwithstanding any applications-related information or support that may be provided by TI. Further, Buyers must fully indemnify TI and its representatives against any damages arising out of the use of TI products in such safety-critical applications.

TI products are neither designed nor intended for use in military/aerospace applications or environments unless the TI products are specifically designated by TI as military-grade or "enhanced plastic." Only products designated by TI as military-grade meet military specifications. Buyers acknowledge and agree that any such use of TI products which TI has not designated as military-grade is solely at the Buyer's risk, and that they are solely responsible for compliance with all legal and regulatory requirements in connection with such use.

TI products are neither designed nor intended for use in automotive applications or environments unless the specific TI products are designated by TI as compliant with ISO/TS 16949 requirements. Buyers acknowledge and agree that, if they use any non-designated products in automotive applications, TI will not be responsible for any failure to meet such requirements.

Following are URLs where you can obtain information on other Texas Instruments products and application solutions:

Products

Audio	www.ti.com/audio
Amplifiers	amplifier.ti.com
Data Converters	dataconverter.ti.com
DLP® Products	www.dlp.com
DSP	dsp.ti.com
Clocks and Timers	www.ti.com/clocks
Interface	interface.ti.com
Logic	logic.ti.com
Power Mgmt	power.ti.com
Microcontrollers	microcontroller.ti.com
RFID	www.ti-rfid.com
OMAP Mobile Processors	www.ti.com/omap
Wireless Connectivity	www.ti.com/wirelessconnectivity

Applications

Communications and Telecom	www.ti.com/communications
Computers and Peripherals	www.ti.com/computers
Consumer Electronics	www.ti.com/consumer-apps
Energy and Lighting	www.ti.com/energy
Industrial	www.ti.com/industrial
Medical	www.ti.com/medical
Security	www.ti.com/security
Space, Avionics and Defense	www.ti.com/space-avionics-defense
Transportation and Automotive	www.ti.com/automotive
Video and Imaging	www.ti.com/video

TI E2E Community Home Page

e2e.ti.com

Mailing Address: Texas Instruments, Post Office Box 655303, Dallas, Texas 75265
Copyright © 2011, Texas Instruments Incorporated