

LM6317

LM6317 120 MHz, Fast Settling, Low Power, Voltage Feedback Amplifier



Literature Number: SNOS788A

LM6317

120 MHz, Fast Settling, Low Power, Voltage Feedback Amplifier

General Description

The LM6317 is a high speed, unity-gain stable voltage feedback amplifier that consumes only 40 mW of quiescent power. Operating at $\pm 5V$ power supply, the LM6317 provides excellent AC performance such as 120 MHz of unity-gain bandwidth, 1500V/ μs of slew rate, and 80 dB of SFDR.

The LM6317 has the slew characteristic of a current feedback amplifier; yet it can be used in all traditional amplifier configurations. The high output current and good stability with capacitive load of LM6317 makes it ideal for driving cables. With its unity-gain stability, fast settling time and low output impedance, the LM6317 can be used to buffer A/D converters. The LM6317 also has very low input voltage and current noise, high CMRR and PSRR, desirable in precision applications such as ATE systems.

Features (Typical unless otherwise noted)

- Easy to use voltage feedback topology
- Unity-gain stability
- Wide unity-gain bandwidth 120 MHz
- Fast slew rate 1100V/ μs
- Fast settling time
 - 0.1% 12 ns
 - 0.01% 18 ns
- Low SFDR @ 1 MHz Driving 100 Ω 80 dB
- High output current 60 mA
- High CMRR and PSRR 80 dB, 74 dB
- Low supply current 4 mA
- Specified for $\pm 5V$ operation

Applications

- Active filters
- A/D Converter buffers
- Video cable drivers
- Communication systems
- Portable systems
- Ultrasound equipment
- ATE systems

Typical Performance

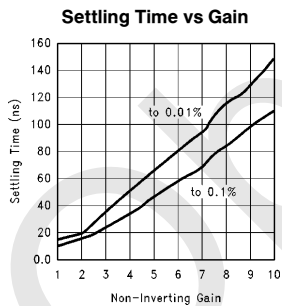

Connection Diagram

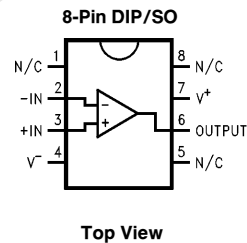

Ordering Information

Package	Temperature Range	Transport Media	NSC Drawing
	Industrial -40°C to +85°C		
8-Pin DIP	LM6317IN	Rails	N08E
8-Pin Small Outline	LM6317IM	Rails	M08A
	LM6317IMX	2.5k Tape and Reel	

TinyPak™ is a trademark of National Semiconductor Corp.

Absolute Maximum Ratings (Note 1)

If Military/Aerospace specified devices are required, please contact the National Semiconductor Sales Office/Distributors for availability and specifications.

ESD Tolerance (Note 2)	
Human Body Model	1.5 kV
Machine Model	200V
Supply Voltage ($V^+ - V^-$)	12V
Differential Input Voltage	10V
Output Current (Note 3)	± 60 mA
Storage Temperature Range	-65°C to $+150^\circ\text{C}$
Maximum Junction Temperature (Note 4)	150°C

Operating Ratings (Note 1)

Supply Voltage	$\pm 2.3\text{V} \leq V_S \leq \pm 6\text{V}$
Junction Temperature Range	$-40^\circ\text{C} \leq T_J \leq +85^\circ\text{C}$
Thermal Resistance (θ_{JA})	
N Package, 8-Pin Molded DIP	$110^\circ\text{C}/\text{W}$
M Package, 8-Pin Surface Mount	$170^\circ\text{C}/\text{W}$

$\pm 5\text{V}$ DC Electrical Characteristics Unless otherwise specified, all limits guaranteed for $T_J = 25^\circ\text{C}$, $V^+ = +5\text{V}$, $V^- = -5\text{V}$, $V_{CM} = 0\text{V}$, and $R_L = 100\Omega$. **Boldface** limits apply at the temperature extremes.

Symbol	Parameter	Conditions	Typ (Note 5)	Limit (Note 6)	Units
V_{OS}	Input Offset Voltage		0.3	5 7	mV max
TC V_{OS}	Input Offset Voltage Average Drift		8		$\mu\text{V}/^\circ\text{C}$
I_B	Input Bias Current		3	12 22	μA max
I_{OS}	Input Offset Current		0.2	2 4	μA max
R_{IN}	Input Resistance	Differential	2		M Ω
		Common	1		
C_{IN}	Input Capacitance	Differential	1		pF
		Common	1		
R_O	Open Loop Output Resistance		0.02		Ω
CMRR	Common Mode Rejection Ratio	$V_{CM} = \pm 1.5\text{V}$	80	62 57	dB min
PSRR	Power Supply Rejection Ratio	$V_S = \pm 5\text{V}$ to $\pm 4.5\text{V}$	74	60 52	dB min
A_V	Large Signal Voltage Gain	$V_{OUT} = \pm 1\text{V}$ $R_L = 1\text{ k}\Omega$	70	55 50	dB min
		$V_{OUT} = \pm 1\text{V}$ $R_L = 100\Omega$	67	53 48	
V_{CM}	Input Common-Mode Voltage Range	CMRR = 60 dB	3.2	2.6 2.3	V min
			-3.2	-2.6 -2.3	V max

± 5V DC Electrical Characteristics (Continued) Unless otherwise specified, all limits guaranteed for $T_J = 25^\circ\text{C}$, $V^+ = +5\text{V}$, $V^- = -5\text{V}$, $V_{\text{CM}} = 0\text{V}$, and $R_L = 100\Omega$. **Boldface** limits apply at the temperature extremes.

Symbol	Parameter	Conditions	Typ (Note 5)	Limit (Note 6)	Units
V_O	Output Swing	$R_L = 1\text{ k}\Omega$	3.5	3 2.6	V min
			-3.5	-3 -2.6	V max
		$R_L = 100\Omega$	3	2.5 2.3	V min
			-3	-2.5 -2.3	V max
I_S	Supply Current		4	6 7	mA max

± 5V AC Electrical Characteristics

Unless otherwise specified, $T_J = 25^\circ\text{C}$, $V^+ = +5\text{V}$, $V^- = 5\text{V}$, $A_V = 1$, and $R_L = 100\Omega$.

Symbol	Parameter	Conditions	Typ (Note 5)	Units
SR	Slew Rate	5V Step	1100	$\text{V}/\mu\text{s}$
		5V Step, $A_V = -1$, $R_L = 500\Omega$	750	
	Unity-Gain Bandwidth	$A_V = -1$, $R_L = 500\Omega$	120	MHz
	-3 dB Frequency	$A_V = +2$	80	MHz
θ_m	Phase Margin	$A_V = -1$, $R_L = 500\Omega$	60	°
t_s	Settling Time	0.1%, 2V Step	12	ns
		0.01%, 2V Step	18	
e_n	Input-Referred Voltage Noise	$f = 100\text{ kHz}$	4.2	$\frac{\text{nV}}{\sqrt{\text{Hz}}}$
i_n	Input-Referred Current Noise	$f = 100\text{ kHz}$	2	$\frac{\text{pA}}{\sqrt{\text{Hz}}}$

Note 1: Absolute Maximum Ratings indicate limits beyond which damage to the device may occur. Operating Ratings indicate conditions for which the device is intended to be functional, but specific performance is not guaranteed. For guaranteed specifications and the test conditions, see the Electrical Characteristics.

Note 2: Human body model, 1.5 k Ω in series with 100 pF. Machine model, 200 Ω in series with 100 pF.

Note 3: Applies to both single-supply and split-supply operation. Sourcing and sinking more than 60 mA at the output may adversely affect reliability.

Note 4: The maximum power dissipation is a function of $T_{J(\text{max})}$, θ_{JA} , and T_A . The maximum allowable power dissipation at any ambient temperature is $P_D = (T_{J(\text{max})} - T_A) / \theta_{JA}$. All numbers apply for packages soldered directly into a PC board.

Note 5: Typical values represent the most likely parametric norm.

Note 6: All limits are guaranteed by testing or statistical analysis.

Typical Performance Characteristics Unless otherwise noted, $T_A = 25^\circ\text{C}$, $V_S = \pm 5\text{V}$

Supply Current vs Supply Voltage

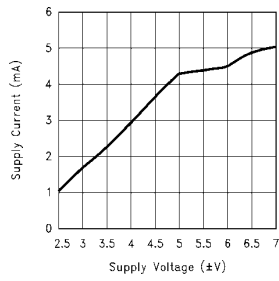

TL/H/12542-3

I_B and I_{OS} vs Common-Mode Voltage

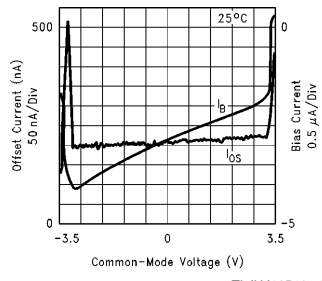

TL/H/12542-4

PSRR, CMRR, and Closed Loop R_o

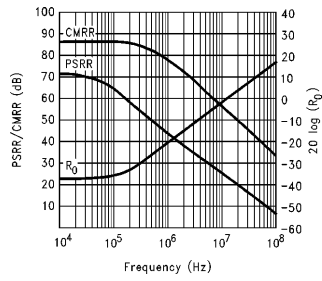

TL/H/12542-5

Open Loop Frequency Response

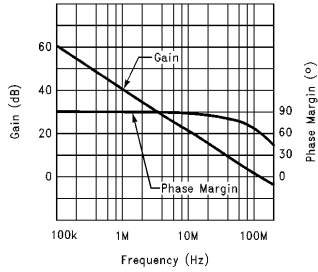

Bandwidth vs Supply Voltage

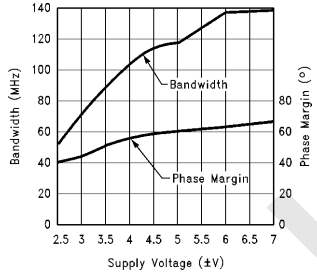

TL/H/12542-7

Bandwidth vs Capacitive Load

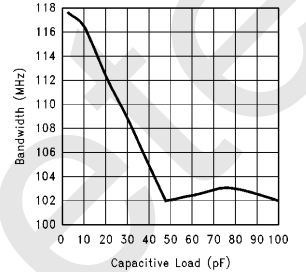

TL/H/12542-8

Non-Inverting Frequency Response

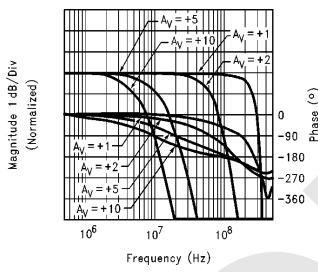

TL/H/12542-9

Inverting Frequency Response

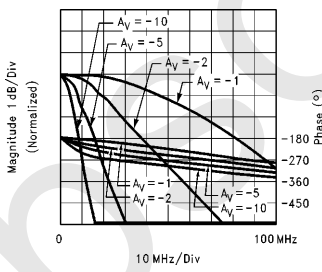

TL/H/12542-10

Equivalent Input Noise

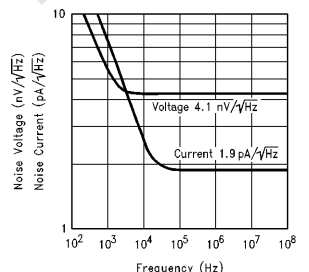

TL/H/12542-11

2nd and 3rd Harmonic Distortion

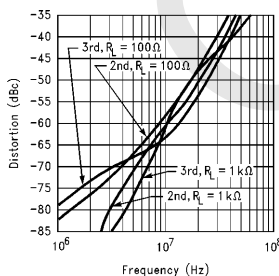

TL/H/12542-12

Settling Time vs Capacitive Load

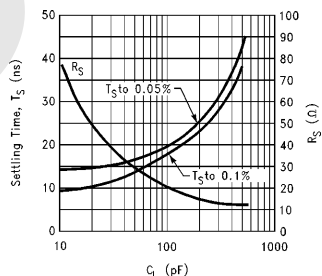

TL/H/12542-13

Maximum Power Dissipation vs Ambient Temperature

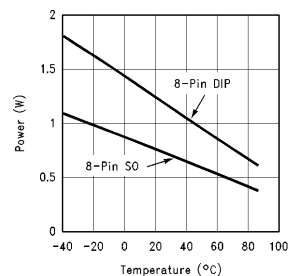

TL/H/12542-24

Typical Performance Characteristics Unless otherwise noted, $T_A = 25^\circ\text{C}$, $V_S = \pm 5\text{V}$ (Continued)

Large Signal Pulse Response
($A_V = +1$)

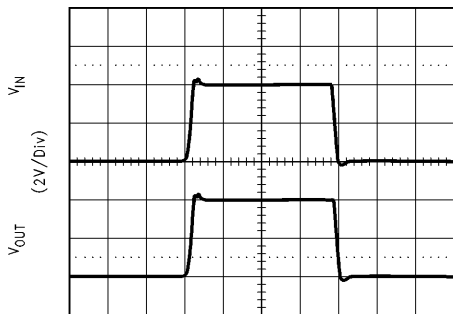

Time (50 ns/Div)

TL/H/12542-1

Small Signal Pulse Response
($A_V = +1$)

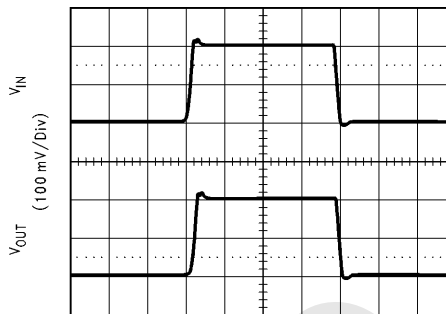

Time (50 ns/Div)

TL/H/12542-15

Large Signal Pulse Response
($A_V = -1$)

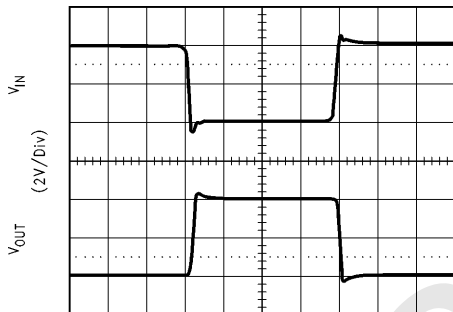

Time (50 ns/Div)

TL/H/12542-16

Small Signal Pulse Response
($A_V = -1$)

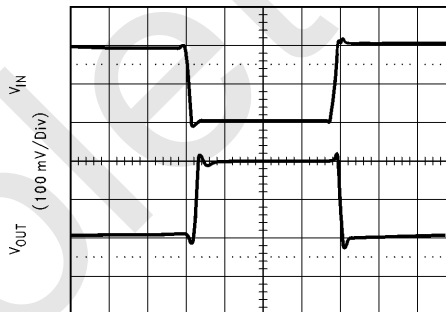

Time (50 ns/Div)

TL/H/12542-17

Large Signal Pulse Response
($A_V = +2$)

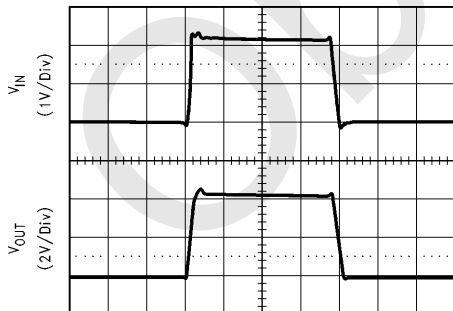

Time (50 ns/Div)

TL/H/12542-18

Small Signal Pulse Response
($A_V = +2$)

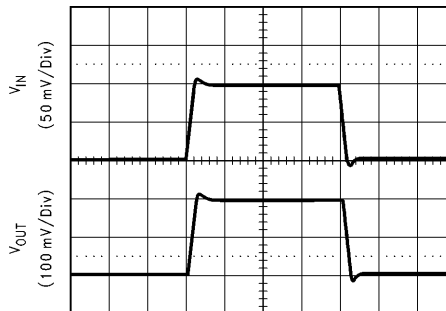

Time (50 ns/Div)

TL/H/12542-19

Application Notes

Using the LM6317

LIMITS AND PRECAUTIONS

The absolute maximum supply voltage which may be applied to the LM6317 is 12V. Designers should not design for more than 10V nominal, and carefully check supply tolerances under all conditions so that the voltages do not exceed the maximum.

DIFFERENTIAL INPUT VOLTAGE

Differential input voltage is the difference in voltage between the non-inverting (+) input and the inverting (-) input of the op amp. The absolute maximum differential input for the LM6317 is 10V across the inputs. This limit also applies when there is no power supplied to the op amp. This may not be a problem in most conventional op amp designs, however, designers should avoid using the LM6317 as comparators or forcing the inputs to different voltages. In some designs, diodes protection may be needed between the inputs, as shown in *Figure 1*.

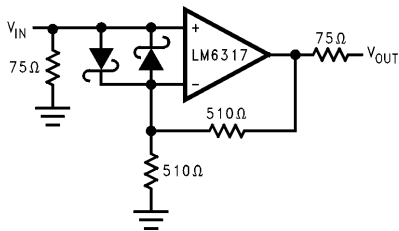

TL/H/12542-20

FIGURE 1. Input Protection for LM6317

Layout Consideration

PRINTED CIRCUIT BOARDS AND HIGH SPEED OP AMPS

There are many things to consider when designing PC boards for high speed op amps. Without proper caution, it is very easy and frustrating to have excessive ringing, oscillation and other degraded AC performance in high speed circuits. As a rule, the signal traces should be short and wide to provide low inductance and low impedance paths. Any unused board space needs be grounded to reduce stray signal pickup. Critical components should also be grounded at a common point to eliminate voltage drop. Sockets add capacitance to the board and can affect frequency performance. It is better to solder the amplifier directly into the PC board without using any socket.

USING PROBES

Active (FET) probes are ideal for taking high frequency measurements because they have wide bandwidth, high input impedance and low input capacitance. However, the probe ground leads provide a long ground loop that will produce errors in measurement. Instead, the probes can be grounded directly by removing the ground leads and probe jackets and using scope probe jacks.

COMPONENTS SELECTION AND FEEDBACK RESISTOR

It is important in high speed applications to keep all component leads short because wires are inductive at high frequency. For discrete components, choose carbon composition-type resistors and mica-type capacitors. Surface mount components are preferred over discrete components for minimum inductive effect.

Large values of feedback resistors can couple with parasitic capacitance and cause undesirable effects such as ringing or oscillation in high speed amplifiers. Feedback resistor value around 1 kΩ is recommended.

COMPENSATION FOR INPUT CAPACITANCE

The combination of an amplifier's input capacitance with the gain setting resistors adds a pole that can cause peaking or oscillation. To solve this problem, a feedback capacitor with a value

$$C_F > (R_G \times C_{IN})/R_F$$

can be used to cancel that pole. The value of C_{IN} can be found in the DC Electrical Characteristics Table of the data-sheet. *Figure 2* illustrates the compensation circuit.

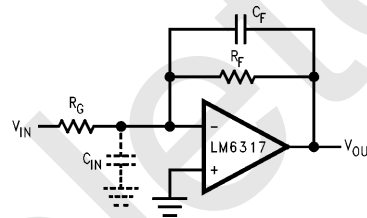

TL/H/12542-21

FIGURE 2. Compensating for Input Capacitance

Power Supply Bypassing

Bypassing the power supply is necessary to maintain low power supply impedance across frequency. Both positive and negative power supplies should be bypassed individually by placing 0.01 μF ceramic capacitors directly to power supply pins and 2.2 μF tantalum capacitors close to the power supply pins.

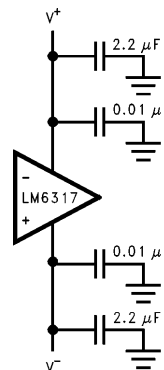

TL/H/12542-22

FIGURE 3. Power Supply Bypassing

Application Notes (Continued)

Termination

In high frequency applications, reflections occur if signals are not properly terminated. To minimize reflection, coaxial cable with matching characteristic impedance to the signal source should be used. The other end of the cable should be terminated with the same value terminator or resistor. For the commonly used cables, RG59 has 75Ω characteristics impedance, and RG58 has 50Ω characteristics impedance.

Driving Capacitive Loads

Amplifiers driving capacitive loads can oscillate or have ringing at the output. To eliminate oscillation or reduce ringing, an isolation resistor can be placed as shown below in *Figure 4*. The combination of the isolation resistor and the load capacitor forms a pole to increase stability by adding more phase margin to the overall system. The desired performance depends on the value of the isolation resistor; the bigger the isolation resistor, the more damped the pulse response becomes. A 50Ω isolation resistor is recommended for initial evaluation.

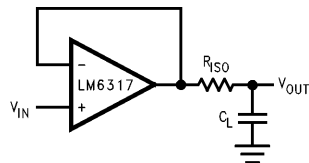

TL/H/12542-23

FIGURE 4. Driving Capacitive Load

Other High Speed and Video Amplifiers

National Semiconductor has an extensive line of high speed amplifiers, with a range of operating voltage from 3V single supply to $\pm 15V$, and a range of package types, such as the space saving SOT23-5 TinyPak™ ($3.05mm \times 3.00mm \times 1.43mm$ - about the size of a grain of rice) and a wide SO-8 for better power dissipation.

This op amp line includes -

LM6171 100 MHz low distortion amplifier with greater than $3000V/\mu s$ slew rate. Voltage feedback design draws only 2.5 mA. Specified at $\pm 15V$ and $\pm 5V$ supplies.

LM7131 TinyPak (SOT23-5) video amplifier with 70 MHz gain bandwidth. Specified at 3V, 5V and $\pm 5V$ supplies.

LM7171 200 MHz voltage feedback amplifier with 100 mA output current and $4000V/\mu s$ slew rate. Supply current of 6.5 mA. Specified at $\pm 15V$ and $\pm 5V$ supplies.

Information on these parts is available from your National Semiconductor representative.

Physical Dimensions inches (millimeters) unless otherwise noted

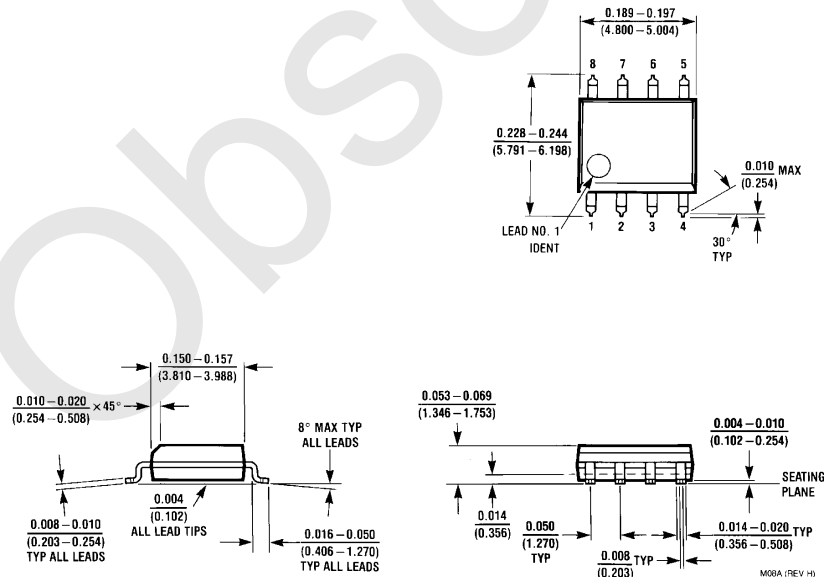

8-Pin Small Outline
Order Number LM6317IM or LM6317IMX
NSC Package Number M08A

Physical Dimensions inches (millimeters) unless otherwise noted (Continued)

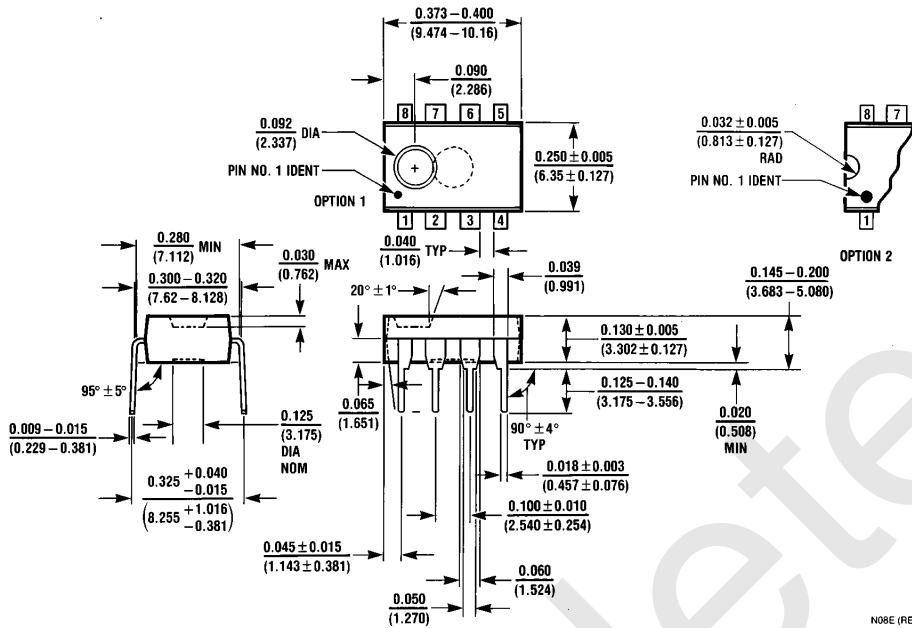

8-Pin DIP
Order Number LM6317IN
NSC Package Number N08E

N08E (REV F)

LIFE SUPPORT POLICY

NATIONAL'S PRODUCTS ARE NOT AUTHORIZED FOR USE AS CRITICAL COMPONENTS IN LIFE SUPPORT DEVICES OR SYSTEMS WITHOUT THE EXPRESS WRITTEN APPROVAL OF THE PRESIDENT OF NATIONAL SEMICONDUCTOR CORPORATION. As used herein:

1. Life support devices or systems are devices or systems which, (a) are intended for surgical implant into the body, or (b) support or sustain life, and whose failure to perform, when properly used in accordance with instructions for use provided in the labeling, can be reasonably expected to result in a significant injury to the user.
2. A critical component is any component of a life support device or system whose failure to perform can be reasonably expected to cause the failure of the life support device or system, or to affect its safety or effectiveness.

 <p>National Semiconductor Corporation 1111 West Bardin Road Arlington, TX 76017 Tel: 1(800) 272-9959 Fax: 1(800) 737-7018 http://www.national.com</p>	<p>National Semiconductor Europe</p> <p>Fax: +49 (0) 180-530 85 86 Email: europe.support@nsc.com Deutsch Tel: +49 (0) 180-530 85 85 English Tel: +49 (0) 180-532 78 32 Français Tel: +49 (0) 180-532 93 58 Italiano Tel: +49 (0) 180-534 16 80</p>	<p>National Semiconductor Hong Kong Ltd. 19th Floor, Straight Block, Ocean Centre, 5 Canton Rd. Tsimshatsui, Kowloon Hong Kong Tel: (852) 2737-1600 Fax: (852) 2736-9960</p>	<p>National Semiconductor Japan Ltd. Tel: 81-043-299-2308 Fax: 81-043-299-2408</p>
---	--	---	---

National does not assume any responsibility for use of any circuitry described, no circuit patent licenses are implied and National reserves the right at any time without notice to change said circuitry and specifications.

IMPORTANT NOTICE

Texas Instruments Incorporated and its subsidiaries (TI) reserve the right to make corrections, modifications, enhancements, improvements, and other changes to its products and services at any time and to discontinue any product or service without notice. Customers should obtain the latest relevant information before placing orders and should verify that such information is current and complete. All products are sold subject to TI's terms and conditions of sale supplied at the time of order acknowledgment.

TI warrants performance of its hardware products to the specifications applicable at the time of sale in accordance with TI's standard warranty. Testing and other quality control techniques are used to the extent TI deems necessary to support this warranty. Except where mandated by government requirements, testing of all parameters of each product is not necessarily performed.

TI assumes no liability for applications assistance or customer product design. Customers are responsible for their products and applications using TI components. To minimize the risks associated with customer products and applications, customers should provide adequate design and operating safeguards.

TI does not warrant or represent that any license, either express or implied, is granted under any TI patent right, copyright, mask work right, or other TI intellectual property right relating to any combination, machine, or process in which TI products or services are used. Information published by TI regarding third-party products or services does not constitute a license from TI to use such products or services or a warranty or endorsement thereof. Use of such information may require a license from a third party under the patents or other intellectual property of the third party, or a license from TI under the patents or other intellectual property of TI.

Reproduction of TI information in TI data books or data sheets is permissible only if reproduction is without alteration and is accompanied by all associated warranties, conditions, limitations, and notices. Reproduction of this information with alteration is an unfair and deceptive business practice. TI is not responsible or liable for such altered documentation. Information of third parties may be subject to additional restrictions.

Resale of TI products or services with statements different from or beyond the parameters stated by TI for that product or service voids all express and any implied warranties for the associated TI product or service and is an unfair and deceptive business practice. TI is not responsible or liable for any such statements.

TI products are not authorized for use in safety-critical applications (such as life support) where a failure of the TI product would reasonably be expected to cause severe personal injury or death, unless officers of the parties have executed an agreement specifically governing such use. Buyers represent that they have all necessary expertise in the safety and regulatory ramifications of their applications, and acknowledge and agree that they are solely responsible for all legal, regulatory and safety-related requirements concerning their products and any use of TI products in such safety-critical applications, notwithstanding any applications-related information or support that may be provided by TI. Further, Buyers must fully indemnify TI and its representatives against any damages arising out of the use of TI products in such safety-critical applications.

TI products are neither designed nor intended for use in military/aerospace applications or environments unless the TI products are specifically designated by TI as military-grade or "enhanced plastic." Only products designated by TI as military-grade meet military specifications. Buyers acknowledge and agree that any such use of TI products which TI has not designated as military-grade is solely at the Buyer's risk, and that they are solely responsible for compliance with all legal and regulatory requirements in connection with such use.

TI products are neither designed nor intended for use in automotive applications or environments unless the specific TI products are designated by TI as compliant with ISO/TS 16949 requirements. Buyers acknowledge and agree that, if they use any non-designated products in automotive applications, TI will not be responsible for any failure to meet such requirements.

Following are URLs where you can obtain information on other Texas Instruments products and application solutions:

Products

Audio	www.ti.com/audio
Amplifiers	amplifier.ti.com
Data Converters	dataconverter.ti.com
DLP® Products	www.dlp.com
DSP	dsp.ti.com
Clocks and Timers	www.ti.com/clocks
Interface	interface.ti.com
Logic	logic.ti.com
Power Mgmt	power.ti.com
Microcontrollers	microcontroller.ti.com
RFID	www.ti-rfid.com
OMAP Mobile Processors	www.ti.com/omap
Wireless Connectivity	www.ti.com/wirelessconnectivity

Applications

Communications and Telecom	www.ti.com/communications
Computers and Peripherals	www.ti.com/computers
Consumer Electronics	www.ti.com/consumer-apps
Energy and Lighting	www.ti.com/energy
Industrial	www.ti.com/industrial
Medical	www.ti.com/medical
Security	www.ti.com/security
Space, Avionics and Defense	www.ti.com/space-avionics-defense
Transportation and Automotive	www.ti.com/automotive
Video and Imaging	www.ti.com/video

TI E2E Community Home Page

e2e.ti.com

Mailing Address: Texas Instruments, Post Office Box 655303, Dallas, Texas 75265
Copyright © 2011, Texas Instruments Incorporated