

# CLC428

*CLC428 Dual Wideband, Low Noise, Voltage Feedback Op Amp*



Literature Number: SNOS822D

## CLC428

# Dual Wideband, Low Noise, Voltage Feedback Op Amp

### General Description

The National CLC428 is a very high speed dual op amp that offers a traditional voltage-feedback topology featuring unity gain stability and slew enhanced circuitry. The CLC428's ultra low noise and very low harmonic distortion combine to form a very wide dynamic range op amp that operates from a single (5 to 12V) or dual ( $\pm 5V$ ) power supply.

Each of the CLC428's closely matched channels provides a 160MHz unity gain bandwidth with an ultra low input voltage noise density ( $2nV/\sqrt{Hz}$ ). Very low 2nd/3rd harmonic distortion ( $-62dB$ ) make the CLC428 a perfect wide dynamic range amplifier for matched I/Q channels.

With its fast and accurate settling (16ns to 0.1%), the CLC428 is also an excellent choice for wide dynamic range, anti-aliasing filters to buffer the inputs of hi-resolution analog-to-digital converters. Combining the CLC428's two tightly matched amplifiers in a single eight-pin SOIC reduces cost and board space for many composite amplifier applications such as active filters, differential line drivers/receivers, fast peak detectors and instrumentation amplifiers.

To reduce design times and assist in board layout, the CLC428 is supported by an evaluation board and a SPICE simulation model available from National.

### Features

- Wide unity gain bandwidth: 160MHz
- Ultra low noise:  $2.0nV/\sqrt{Hz}$
- Low Distortion:  $-78dBc$  2nd (2MHz)
- Low Distortion:  $-62/-72dBc$  (10MHz)

- Settling time: 16ns to 0.1%
- Supply voltage range:  $\pm 2.5$  to  $\pm 5$  or single supply
- High output current:  $\pm 70mA$

### Applications

- General purpose dual op amp
- Low noise integrators
- Low noise active filters
- Diff-in/diff-out instrumentation amp
- Driver/receiver for transmission systems
- High speed detectors I/Q channel amplifiers

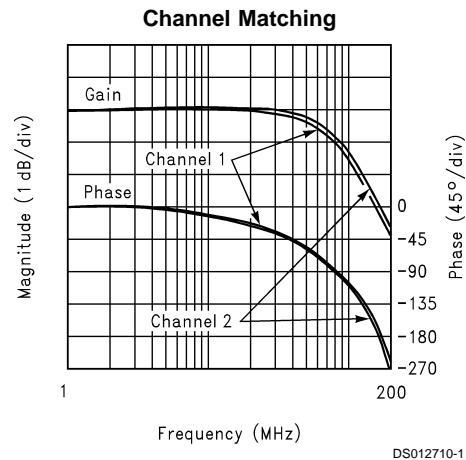

### Typical Application

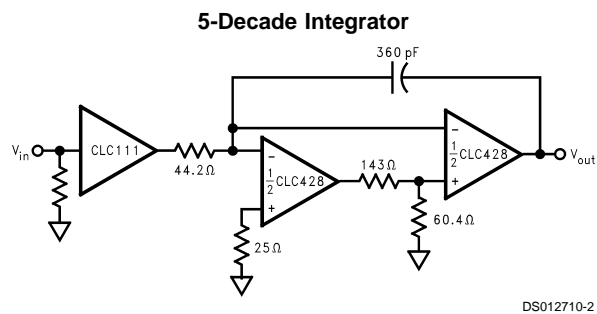
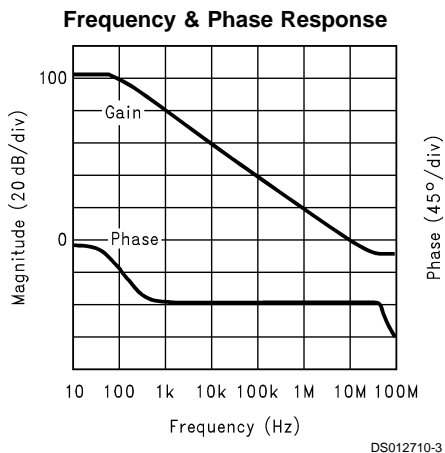

## Connection Diagram

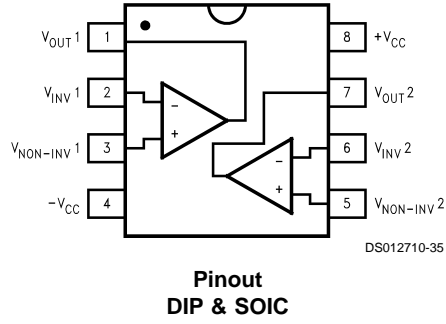

## Ordering Information

Package	Temperature Range Industrial	Part Number	Package Marking	NSC Drawing
8-pin plastic DIP	-40°C to +85°C	CLC428AJP	CLC428AJP	N08E
8-pin plastic SOIC	-40°C to +85°C	CLC428AJE	CLC428AJE	M08A

**Absolute Maximum Ratings** (Note 1)

If Military/Aerospace specified devices are required, please contact the National Semiconductor Sales Office/Distributors for availability and specifications.

Supply Voltage	±7V
Short Circuit Current	(see note 6)
Common-Mode Input Voltage	±V <sub>CC</sub>
Differential Input Voltage	±10V
Maximum Junction Temperature	+150°C

Storage Temperature Range	-65°C to +150°C
Lead Temperature (soldering 10 sec)	+300°C

**Operating Ratings**

Thermal Resistance		
Package	( $\theta_{JC}$ )	( $\theta_{JA}$ )
MDIP	60°C/W	115°C/W
SOIC	40°C/W	115°C/W

**Electrical Characteristics**

V<sub>CC</sub> = ±5 V, A<sub>V</sub> = +2V/V, R<sub>f</sub> = 100Ω, R<sub>g</sub> = 100Ω, R<sub>L</sub> = 100Ω; unless specified.

Symbol	Parameter	Conditions	Typ	Min/Max Ratings (Note 2)			Units
	Ambient Temperature	CLC428AJ	+25°C	+25°C	0 to +70°C	-40 to +85°C	
<b>Frequency Domain Response</b>							
	Gain Bandwidth Product	V <sub>OUT</sub> < 0.5V <sub>PP</sub>	135	100	80	70	MHz
	-3dB Bandwidth, A <sub>V</sub> = +1	V <sub>OUT</sub> < 0.5V <sub>PP</sub>	160	120	90	80	MHz
	A <sub>V</sub> = +2	V <sub>OUT</sub> < 0.5V <sub>PP</sub>	80	50	40	35	MHz
		V <sub>OUT</sub> < 5.0V <sub>PP</sub>	40	25	22	20	MHz
	Gain Flatness	V <sub>OUT</sub> < 0.5V <sub>PP</sub>					
	Peaking	DC to 200MHz	0.0	0.6	0.8	1.0	dB
	Rolloff	DC to 20MHz	0.05	0.5	0.7	0.7	dB
	Linear Phase Deviation	DC to 20MHz	0.2	1.0	1.5	1.5	deg
<b>Time Domain Response</b>							
	Rise and Fall Time	1V Step	5.5	7.5	9.0	10.0	ns
	Settling Time	2V Step to 0.1%	16	20	24	24	ns
	Overshoot	1V Step	1	5	10	10	%
	Slew Rate	5V Step	500	300	275	250	V/μs
<b>Distortion And Noise Response</b>							
	2nd Harmonic Distortion	1V <sub>PP</sub> , 10MHz	-62	-50	-45	-43	dBc
	3rd Harmonic Distortion	1V <sub>PP</sub> , 10MHz	-72	-60	-56	-56	dBc
	Equivalent Input Noise						
	Voltage	1MHz to 100MHz	2.0	2.5	2.8	2.8	nV/√Hz
	Current	1MHz to 100MHz	2.0	3.0	3.6	4.6	pA/√Hz
	Crosstalk	Input Referred, 10MHz	-62	-58	-58	-58	dB
<b>Static, DC Performance</b>							
	Open-Loop Gain		60	56	50	50	dB
	Input Offset Voltage (Note 3)		1.0	2.0	3.0	3.5	mV
	Average Drift		5	-	15	20	μV/°C
	Input Bias Current (Note 3)		1.5	25	40	65	μA
	Average Drift		150	-	600	700	nA/°C
	Input Offset Current		0.3	3	5	5	μA
	Average Drift		5	-	25	50	nA/°C
	Power Supply Rejection Ratio (Note 4)		66	60	55	55	dB
	Common-Mode Rejection Ratio		63	57	52	52	dB
	Supply Current (Note 3)	Per Channel, R <sub>L</sub> = ∞	11	12	13	15	mA

## Electrical Characteristics (Continued)

$V_{CC} = \pm 5\text{ V}$ ,  $A_V = +2\text{V/V}$ ,  $R_f = 100\Omega$ ,  $R_g = 100\Omega$ ,  $R_L = 100\Omega$ ; unless specified.

Symbol	Parameter	Conditions	Typ	Min/Max Ratings (Note 2)			Units
<b>Miscellaneous Performance</b>							
	Input Resistance	Common-Mode	500	250	125	125	k $\Omega$
		Differential-Mode	200	50	25	25	k $\Omega$
	Input Capacitance	Common-Mode	2.0	3.0	3.0	3.0	pF
		Differential-Mode	2.0	3.0	3.0	3.0	pF
	Output Resistance	Closed-Loop	0.05	0.1	0.2	0.2	$\Omega$
	Output Voltage Range	$R_L = \infty$	$\pm 3.8$	$\pm 3.5$	$\pm 3.3$	$\pm 3.3$	V
		$R_L = 100\Omega$	$\pm 3.5$	$\pm 3.2$	$\pm 2.6$	$\pm 1.3$	V
	Input Voltage Range	Common- Mode	$\pm 3.7$	$\pm 3.5$	$\pm 3.3$	$\pm 3.3$	V
	Output Current		$\pm 70$	$\pm 50$	$\pm 40$	$\pm 20$	mA

**Note 1:** "Absolute Maximum Ratings" are those values beyond which the safety of the device cannot be guaranteed. They are not meant to imply that the devices should be operated at these limits. The table of "Electrical Characteristics" specifies conditions of device operation.

**Note 2:** Min/max ratings are based on product characterization and simulation. Individual parameters are tested as noted. Outgoing quality levels are determined from tested parameters.

**Note 3:** J-level: spec. is 100% tested at +25°C, sample tested at +85°C.

**Note 4:** J-level: spec. is 100% tested at +25°C.

**Note 5:** Specifications guaranteed using 0.5V<sub>pp</sub> but tested at 0.1 V<sub>pp</sub>.

**Note 6:** Output is short circuit protected to ground, however maximum reliability is obtained if output current does not exceed 160mA.

## Typical Performance Characteristics ( $T_A = +25^\circ$ , $A_V = +2$ , $V_{CC} = \pm 5\text{V}$ , $R_f = 100\Omega$ , $R_L = 100\Omega$ , unless specified)

### Non-Inverting Frequency Response

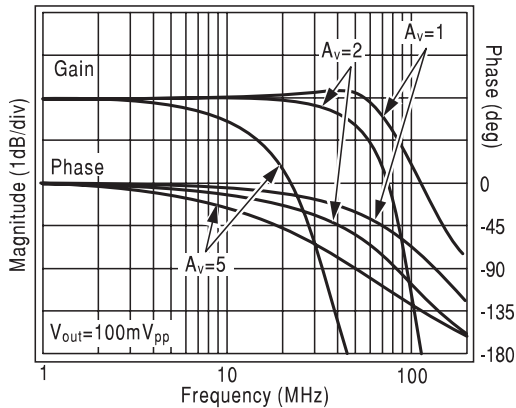

### Inverting Frequency Response

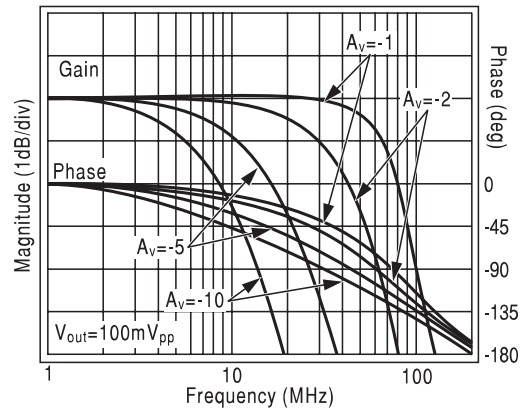

### Frequency Response vs. Load Resistance

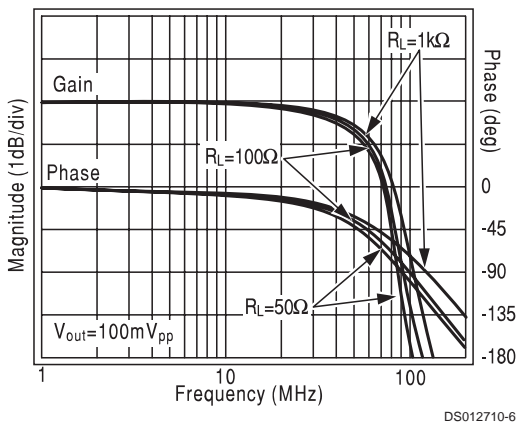

### Frequency Response vs. Output Amplitude

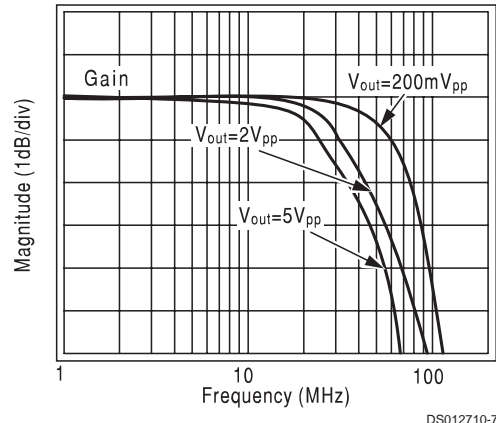

**Typical Performance Characteristics** ( $T_A = +25^\circ$ ,  $A_V = +2$ ,  $V_{CC} = \pm 5V$ ,  $R_f = 100\Omega$ ,  $R_L = 100\Omega$ , unless specified) (Continued)

**Frequency Response vs. Capacitive Load**

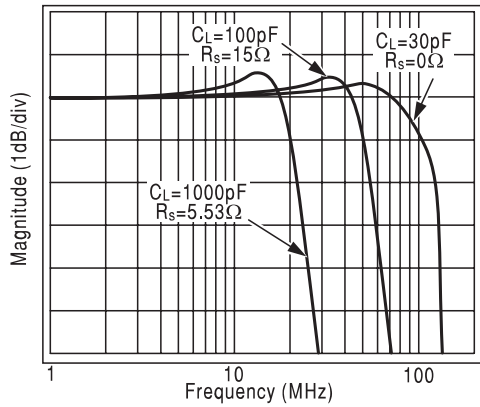

DS012710-8

**Gain Flatness & Linear Phase Deviation**

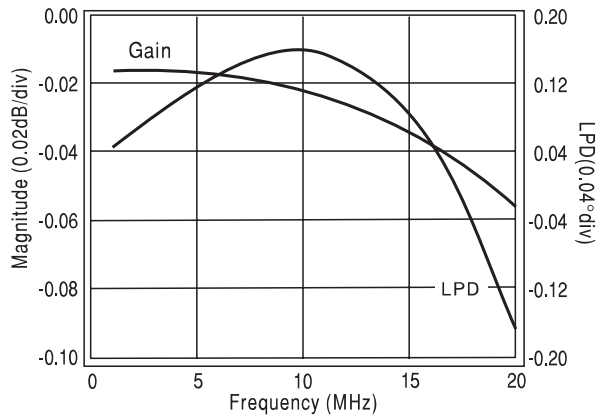

DS012710-9

**Maximum Output Voltage vs. Load**

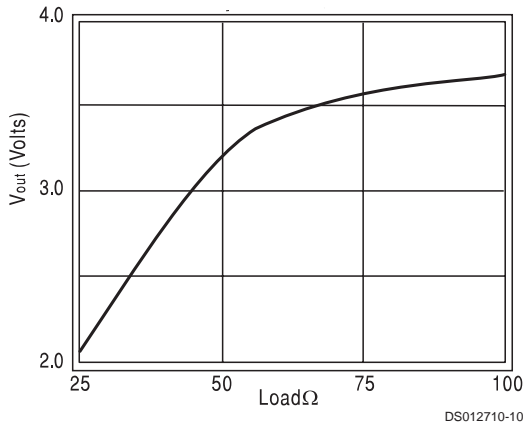

DS012710-10

**Channel-to-Channel Crosstalk**

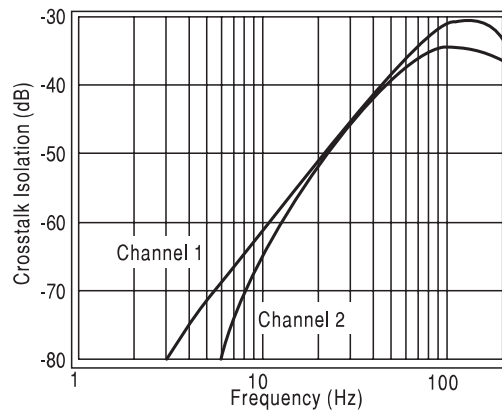

DS012710-11

**Open-Loop Gain & Phase**

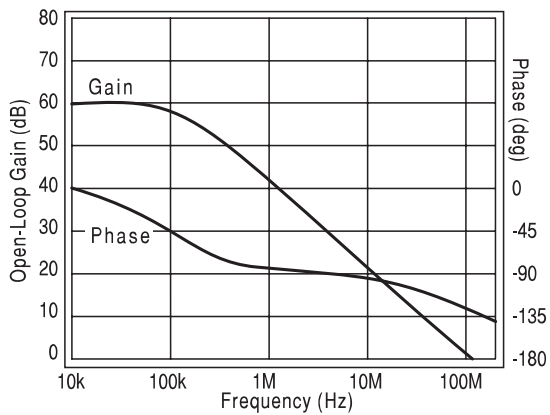

DS012710-12

**2nd and 3rd Harmonic Distortion**

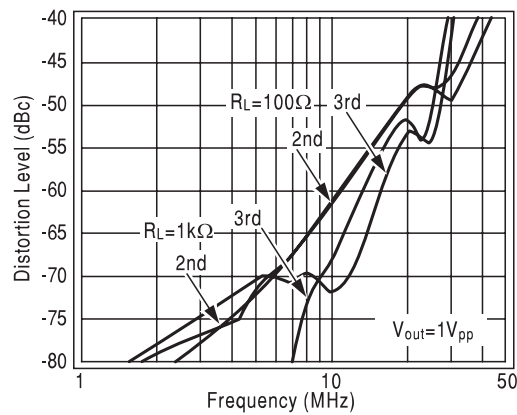

DS012710-13

**Typical Performance Characteristics** ( $T_A = +25^\circ$ ,  $A_V = +2$ ,  $V_{CC} = \pm 5V$ ,  $R_f = 100\Omega$ ,  $R_L = 100\Omega$ , unless specified) (Continued)

**2nd Harmonic Distortion vs. Output Voltage**

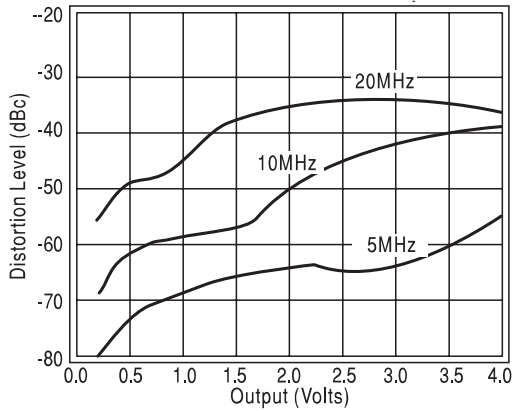

DS012710-14

**3rd Harmonic Distortion vs. Output Voltage**

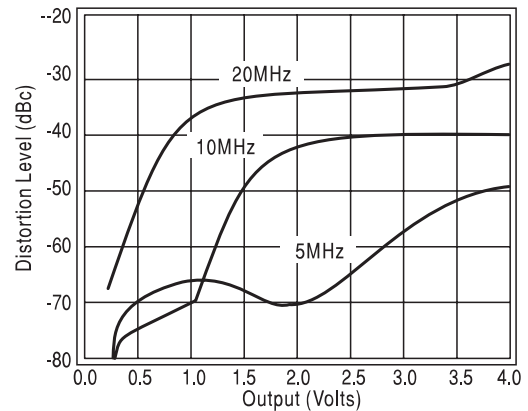

DS012710-15

**Closed-Loop Output Resistance**

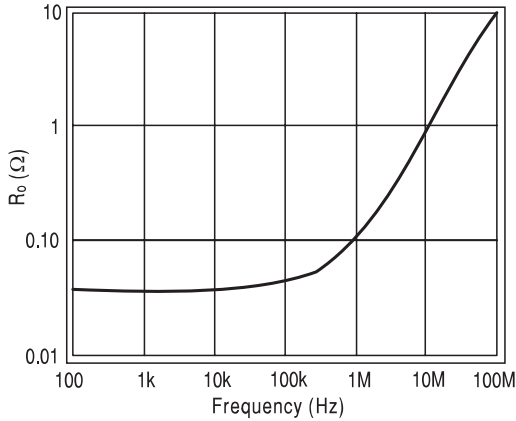

DS012710-16

**Equivalent Input Noise**

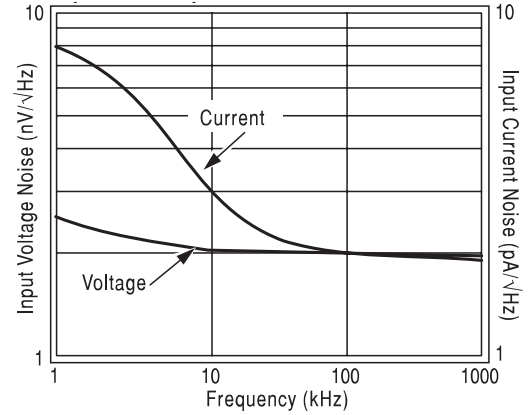

DS012710-17

**2-Tone, 3rd Order Intermodulation Intercept**

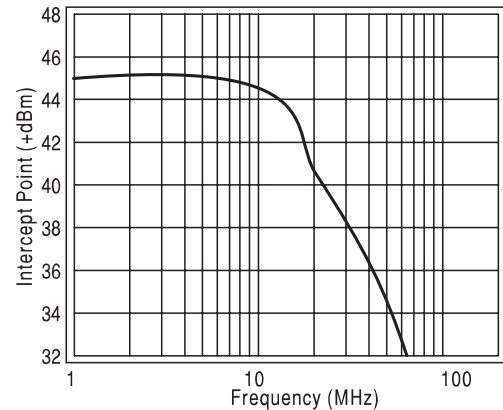

DS012710-18

**Pulse Response ( $V_{OUT} = 100V$ )**

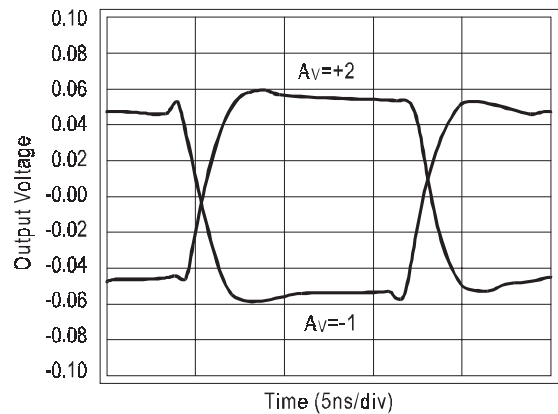

DS012710-19

**Typical Performance Characteristics** ( $T_A = +25^\circ$ ,  $A_V = +2$ ,  $V_{CC} = \pm 5V$ ,  $R_f = 100\Omega$ ,  $R_L = 100\Omega$ , unless specified) (Continued)

**Pulse Response ( $V_{OUT} = 2V$ )**

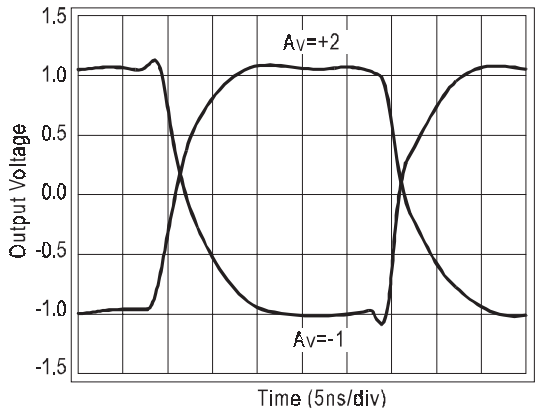

**Setting Time vs. Capacitive Load**

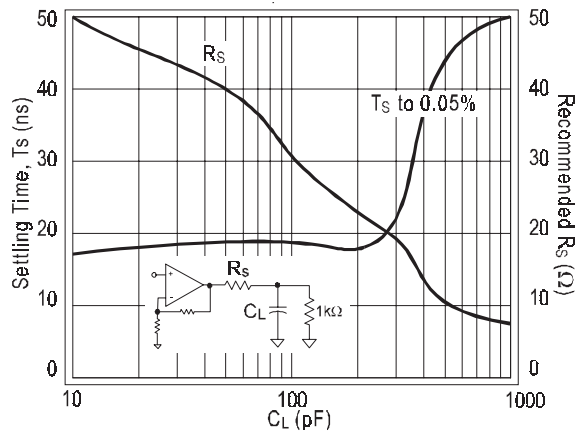

**Short-Term Settling Time**

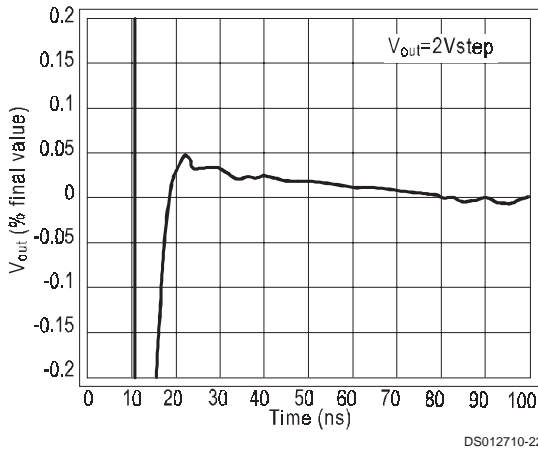

**CMRR and PSRR**

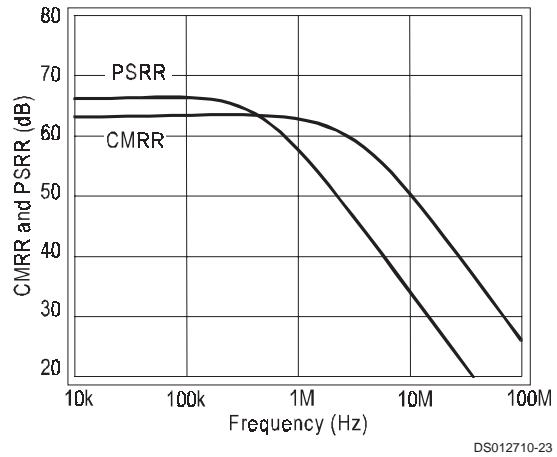

**Typical DC Errors vs. Temperature**

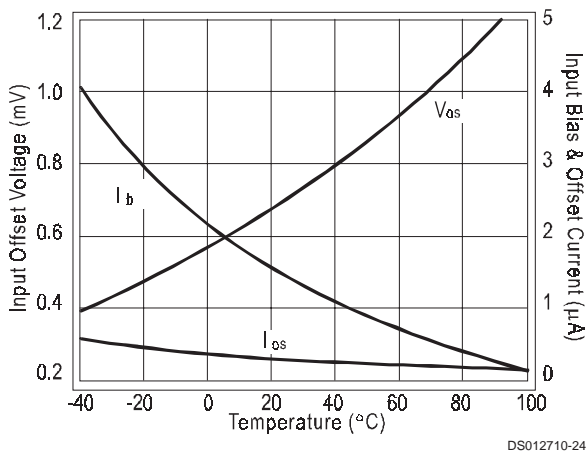



## Application Division

### Low Noise Design

Ultimate low noise performance from circuit designs using the CLC428 requires the proper selection of external resistors. By selecting appropriate low valued resistors for  $R_f$  and  $R_g$ , amplifier circuits using the CLC428 can achieve output noise that is approximately the equivalent voltage input noise of  $2.0 \text{ nV}/\sqrt{\text{Hz}}$  multiplied by the desired gain ( $A_v$ ).

Each amplifier in the CLC428 has an equivalent input noise resistance which is optimum for matching source impedances of approximately 1k. Using a transformer, any source can be matched to achieve the lowest noise design.

For even lower noise performance than the CLC428, consider the CLC425 or CLC426 at  $1.05$  and  $1.6 \text{ nV}/\sqrt{\text{Hz}}$ , respectively.

### DC Bias Currents and Offset Voltages

Cancellation of the output offset voltage due to input bias currents is possible with the CLC428. This is done by making the resistance seen from the inverting and non-inverting inputs equal. Once done, the residual output offset voltage will be the input offset voltage ( $V_{os}$ ) multiplied by the desired gain ( $A_v$ ). Comlinear Application Note OA-7 offers several solutions to further reduce the output offset.

### Output and Supply Considerations

With  $\pm 5\text{V}$  supplies, the CLC428 is capable of a typical output swing of  $\pm 3.8\text{V}$  under a no-load condition. Additional output swing is possible with slightly higher supply voltages. For loads of less than  $50\Omega$ , the output swing will be limited by the CLC428's output current capability, typically  $80\text{mA}$ .

Output settling time when driving capacitive loads can be improved by the use of a series output resistor. See the plot labeled 'Settling Time vs. Capacitive Load' in the Typical Performance section.

### Layout

Proper power supply bypassing is critical to insure good high frequency performance and low noise. De-coupling capacitors of  $0.1\mu\text{F}$  should be placed as close as possible to the power supply pins. The use of surface mounted capacitors is recommended due to their low series inductance.

A good high frequency layout will keep power supply and ground traces away from the inverting input and output pins. Parasitic capacitance from these nodes to ground causes frequency response peaking and possible circuit oscillation. See OA-15 for more information. National suggests the 730038 (through-hole) or the 730036 (SOIC) dual op amp evaluation board as a guide for high frequency layout and as an aid in device evaluation.

### Analog Delay Circuit (All-Pass Network)

The circuit in *Figure 1* implements an all-pass network using the CLC428. A wide bandwidth buffer (CLC111) drives the circuit and provides a high input impedance for the source. As shown in *Figure 2*, the circuit provides a  $13.1\text{ns}$  delay (with  $R = 40.2\Omega$ ,  $C = 47\text{pF}$ ).  $R_f$  and  $R_g$  should be of equal and low value for parasitic insensitive operation.

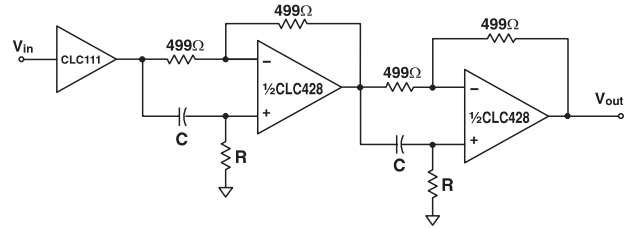

DS012710-25

FIGURE 1.

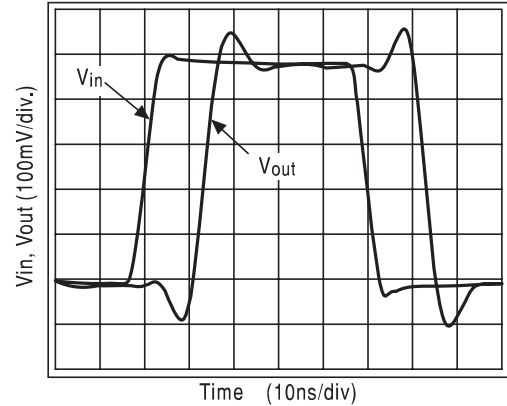

DS012710-26

FIGURE 2. Delay Circuit Response to 0.5V Pulse

The circuit gain is  $+1$  and the delay is determined by the following equations.

$$\tau_{\text{delay}} = 2(2RC + T_d) \quad (1)$$

$$T_d = \frac{1}{360} \frac{d\phi}{df}; \quad (2)$$

where  $T_d$  is the delay of the op amp at  $A_v=+1$ .

The CLC428 provides a typical delay of  $2.8\text{ns}$  at its  $-3\text{dB}$  point.

### Full Duplex Digital or Analog Transmission

Simultaneous transmission and reception of analog or digital signals over a single coaxial cable or twisted-pair line can reduce cabling requirements. The CLC428's wide bandwidth and high common-mode rejection in a differential amplifier configuration allows full duplex transmission of video, telephone, control and audio signals.

In the circuit shown in *Figure 3*, one of the CLC428's amps is used as a 'driver' and the other as a difference 'receiver' amplifier. The output impedance of the 'driver' is essentially zero. The two  $R$ 's are chosen to match the characteristic impedance of the transmission line. The 'driver' op amp gain can be selected for unity or greater.

Receiver amplifier  $A_2$  ( $B_2$ ) is connected across  $R$  and forms differential amplifier for the signals transmitted by driver  $A_1$  ( $B_1$ ). If the coax cable is lossless and  $R_f$  equals  $R_g$ , receiver  $A_2$  ( $B_1$ ) will then reject the signals from driver  $A_1$  ( $B_1$ ) and pass the signals from driver  $B_1$  ( $A_1$ ).

## Application Division (Continued)

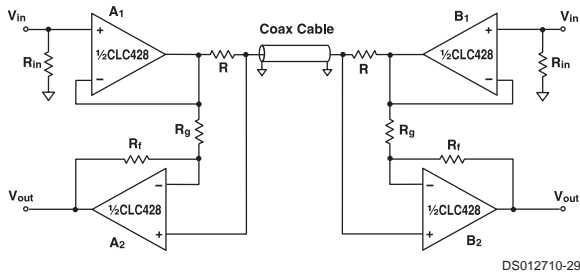

FIGURE 3.

The output of the receiver amplifier will be:

$$V_{out_{A(B)}} = \frac{1}{2} V_{in_{A(B)}} \left[ 1 - \frac{R_f}{R_g} \right] + \frac{1}{2} V_{in_{B(A)}} \left[ 1 + \frac{R_f}{R_g} \right] \quad (3)$$

Care must be given to layout and component placement to maintain a high frequency common-mode rejection. The plot of Figure 4 shows the simultaneous reception of signals transmitted at 1MHz and 10MHz.

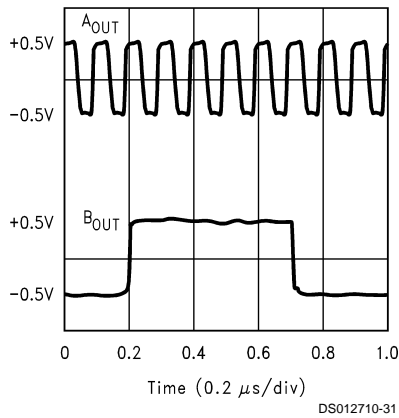

FIGURE 4.

### Five Decade Integrator

A composite integrator, as shown in Figure 5, uses the CLC428 dual op amp to increase the circuits' usable frequency range of operation. The transfer function of this circuit is:

$$V_0 = \frac{1}{RC} \int V_{IN} dt \quad (4)$$

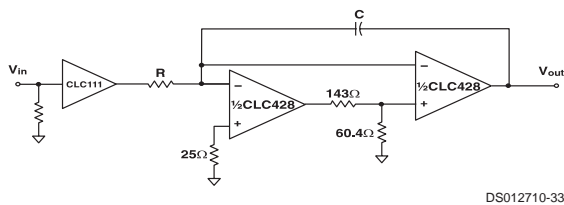

FIGURE 5.

A resistive divider made from the 143Ω and 60.4Ω resistors was chosen to reduce the loop-gain and stabilize the network. The CLC428 composite integrator provides integration over five decades of operation. R and C set the integrator's gain. Figure 6 shows the frequency and phase response of the circuit in Figure 5 with R = 44.2Ω and C = 360pF.

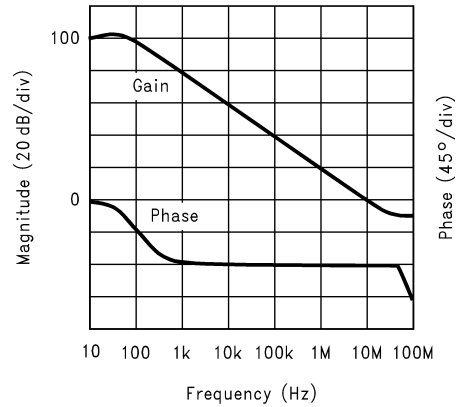

FIGURE 6.

### Positive Peak Detector

The CLC428's dual amplifiers can be used to implement a unity-gain peak detector circuit as shown in Figure 7.

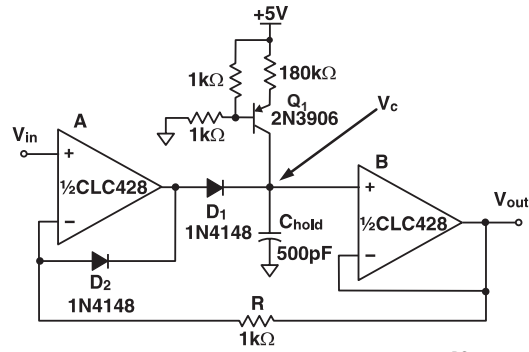

FIGURE 7.

The acquisition speed of this circuit is limited by the dynamic resistance of the diode when charging C<sub>hold</sub>. A plot of the circuit's performance is shown in Figure 8 with a 1MHz sinusoidal input.

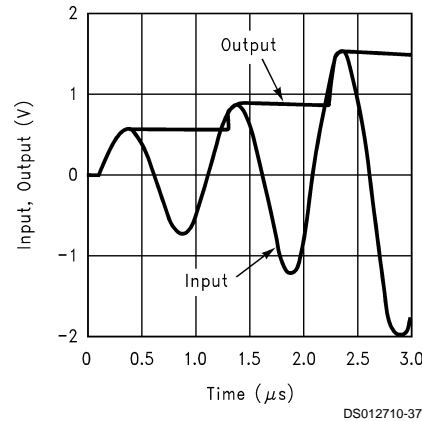

FIGURE 8.

## Application Division (Continued)

A current source, built around Q1, provides the necessary bias current for the second amplifier and prevents saturation when power is applied. The resistor, R, closes the loop while diode D2 prevents negative saturation when  $V_{in}$  is less than  $V_C$ . A MOS-type switch (not shown) can be used to reset the capacitor's voltage.

The maximum speed of detection is limited by the delay of the op amps and the diodes. The use of Schottky diodes will provide faster response.

### Adjustable or Bandpass Equalizer

A 'boost' equalizer can be made with the CLC428 by summing a bandpass response with the input signal, as shown in Figure 9.

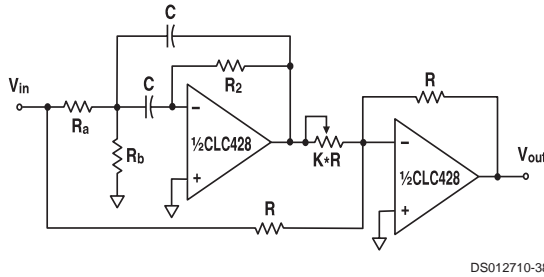

FIGURE 9.

The overall transfer function is shown in Eq. 5.

$$\frac{V_{out}}{V_{in}} = \left[ \frac{R_b}{K(R_a + R_b)} \right] \frac{s2Q\omega_o}{s^2 + s \frac{\omega_o}{Q} + \omega_o^2} - 1 \quad (5)$$

To build a boost circuit, use the design equations Eq. 6 and Eq. 7.

$$\frac{R_2 C}{2} = \frac{Q}{\omega_o} \quad (6)$$

$$2C(R_a \parallel R_b) = \frac{1}{Q\omega_o}$$

Select  $R_2$  and  $C$  using Eq. 6. Use reasonable values for high frequency circuits -  $R_2$  between  $10\Omega$  and  $5k\Omega$ ,  $C$  between  $10pF$  and  $2000pF$ . Use Eq. 7 to determine the parallel combination of  $R_a$  and  $R_b$ . Select  $R_a$  and  $R_b$  by either the  $10\Omega$  to  $5k\Omega$  criteria or by other requirements based on the impedance  $V_{in}$  is capable of driving. Finish the design by determining the value of  $K$  from Eq. 8.

$$\text{Peak Gain} = \frac{V_{out}}{V_{in}}(\omega_o) = \frac{R_2}{2KR_a} - 1 \quad (7)$$

Figure 10 shows an example of the response of the circuit of Figure 9, where  $f_o$  is  $2.3MHz$ . The component values are as follows:  $R_a = 2.1k\Omega$ ,  $R_2 = 68.5\Omega$ ,  $R_2 = 4.22k\Omega$ ,  $R = 500\Omega$ ,  $KR = 50\Omega$ ,  $C = 120pF$ .

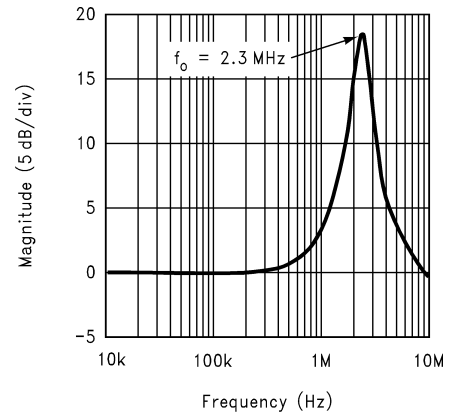
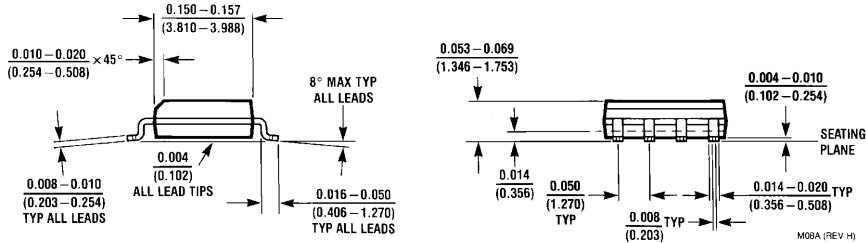
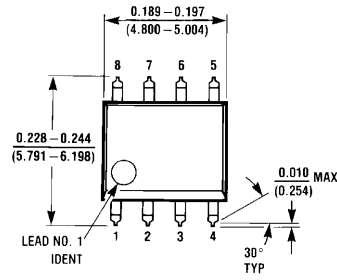
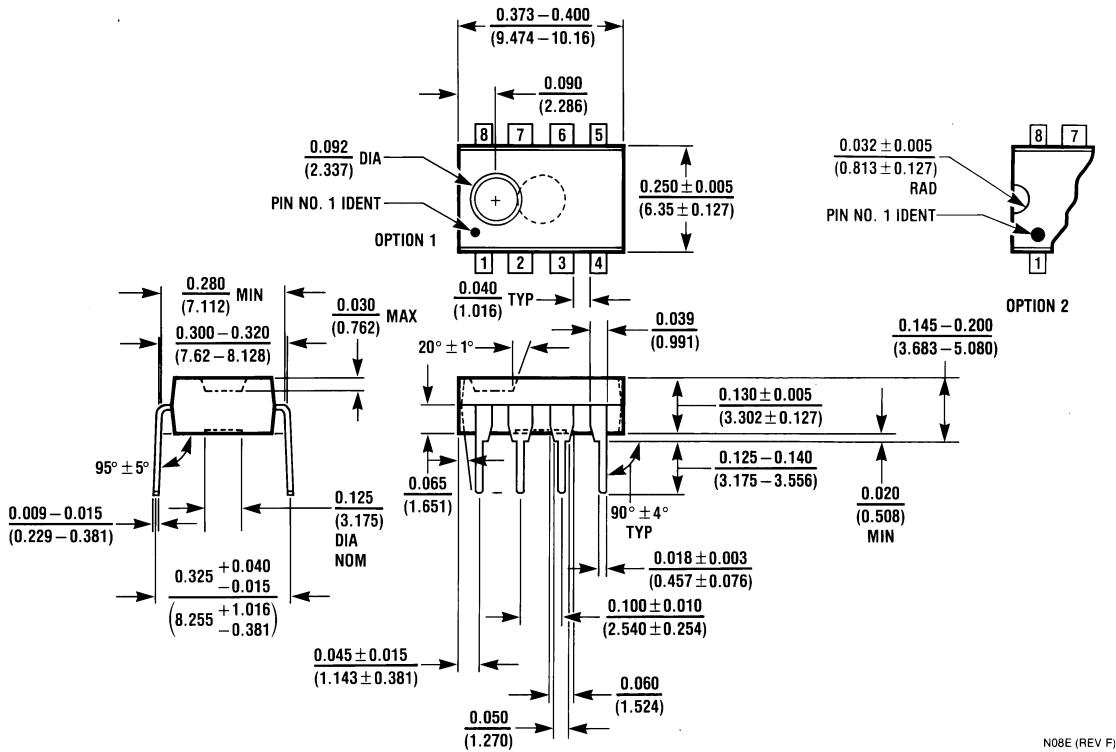

FIGURE 10.

**Physical Dimensions** inches (millimeters) unless otherwise noted



**8-Pin SOIC**  
NS Package Number M08A



**8-Pin MDIP**  
NS Package Number N08E

## Notes

### LIFE SUPPORT POLICY

NATIONAL'S PRODUCTS ARE NOT AUTHORIZED FOR USE AS CRITICAL COMPONENTS IN LIFE SUPPORT DEVICES OR SYSTEMS WITHOUT THE EXPRESS WRITTEN APPROVAL OF THE PRESIDENT AND GENERAL COUNSEL OF NATIONAL SEMICONDUCTOR CORPORATION. As used herein:

1. Life support devices or systems are devices or systems which, (a) are intended for surgical implant into the body, or (b) support or sustain life, and whose failure to perform when properly used in accordance with instructions for use provided in the labeling, can be reasonably expected to result in a significant injury to the user.
2. A critical component is any component of a life support device or system whose failure to perform can be reasonably expected to cause the failure of the life support device or system, or to affect its safety or effectiveness.



**National Semiconductor Corporation**  
Americas  
Email: support@nsc.com

[www.national.com](http://www.national.com)

**National Semiconductor Europe**  
Fax: +49 (0) 180-530 85 86  
Email: europe.support@nsc.com  
Deutsch Tel: +49 (0) 69 9508 6208  
English Tel: +44 (0) 870 24 0 2171  
Français Tel: +33 (0) 1 41 91 8790

**National Semiconductor Asia Pacific Customer Response Group**  
Tel: 65-2544466  
Fax: 65-2504466  
Email: ap.support@nsc.com

**National Semiconductor Japan Ltd.**  
Tel: 81-3-5639-7560  
Fax: 81-3-5639-7507

## IMPORTANT NOTICE

Texas Instruments Incorporated and its subsidiaries (TI) reserve the right to make corrections, modifications, enhancements, improvements, and other changes to its products and services at any time and to discontinue any product or service without notice. Customers should obtain the latest relevant information before placing orders and should verify that such information is current and complete. All products are sold subject to TI's terms and conditions of sale supplied at the time of order acknowledgment.

TI warrants performance of its hardware products to the specifications applicable at the time of sale in accordance with TI's standard warranty. Testing and other quality control techniques are used to the extent TI deems necessary to support this warranty. Except where mandated by government requirements, testing of all parameters of each product is not necessarily performed.

TI assumes no liability for applications assistance or customer product design. Customers are responsible for their products and applications using TI components. To minimize the risks associated with customer products and applications, customers should provide adequate design and operating safeguards.

TI does not warrant or represent that any license, either express or implied, is granted under any TI patent right, copyright, mask work right, or other TI intellectual property right relating to any combination, machine, or process in which TI products or services are used. Information published by TI regarding third-party products or services does not constitute a license from TI to use such products or services or a warranty or endorsement thereof. Use of such information may require a license from a third party under the patents or other intellectual property of the third party, or a license from TI under the patents or other intellectual property of TI.

Reproduction of TI information in TI data books or data sheets is permissible only if reproduction is without alteration and is accompanied by all associated warranties, conditions, limitations, and notices. Reproduction of this information with alteration is an unfair and deceptive business practice. TI is not responsible or liable for such altered documentation. Information of third parties may be subject to additional restrictions.

Resale of TI products or services with statements different from or beyond the parameters stated by TI for that product or service voids all express and any implied warranties for the associated TI product or service and is an unfair and deceptive business practice. TI is not responsible or liable for any such statements.

TI products are not authorized for use in safety-critical applications (such as life support) where a failure of the TI product would reasonably be expected to cause severe personal injury or death, unless officers of the parties have executed an agreement specifically governing such use. Buyers represent that they have all necessary expertise in the safety and regulatory ramifications of their applications, and acknowledge and agree that they are solely responsible for all legal, regulatory and safety-related requirements concerning their products and any use of TI products in such safety-critical applications, notwithstanding any applications-related information or support that may be provided by TI. Further, Buyers must fully indemnify TI and its representatives against any damages arising out of the use of TI products in such safety-critical applications.

TI products are neither designed nor intended for use in military/aerospace applications or environments unless the TI products are specifically designated by TI as military-grade or "enhanced plastic." Only products designated by TI as military-grade meet military specifications. Buyers acknowledge and agree that any such use of TI products which TI has not designated as military-grade is solely at the Buyer's risk, and that they are solely responsible for compliance with all legal and regulatory requirements in connection with such use.

TI products are neither designed nor intended for use in automotive applications or environments unless the specific TI products are designated by TI as compliant with ISO/TS 16949 requirements. Buyers acknowledge and agree that, if they use any non-designated products in automotive applications, TI will not be responsible for any failure to meet such requirements.

Following are URLs where you can obtain information on other Texas Instruments products and application solutions:

### Products

Audio	<a href="http://www.ti.com/audio">www.ti.com/audio</a>
Amplifiers	<a href="http://amplifier.ti.com">amplifier.ti.com</a>
Data Converters	<a href="http://dataconverter.ti.com">dataconverter.ti.com</a>
DLP® Products	<a href="http://www.dlp.com">www.dlp.com</a>
DSP	<a href="http://dsp.ti.com">dsp.ti.com</a>
Clocks and Timers	<a href="http://www.ti.com/clocks">www.ti.com/clocks</a>
Interface	<a href="http://interface.ti.com">interface.ti.com</a>
Logic	<a href="http://logic.ti.com">logic.ti.com</a>
Power Mgmt	<a href="http://power.ti.com">power.ti.com</a>
Microcontrollers	<a href="http://microcontroller.ti.com">microcontroller.ti.com</a>
RFID	<a href="http://www.ti-rfid.com">www.ti-rfid.com</a>
OMAP Mobile Processors	<a href="http://www.ti.com/omap">www.ti.com/omap</a>
Wireless Connectivity	<a href="http://www.ti.com/wirelessconnectivity">www.ti.com/wirelessconnectivity</a>

### Applications

Communications and Telecom	<a href="http://www.ti.com/communications">www.ti.com/communications</a>
Computers and Peripherals	<a href="http://www.ti.com/computers">www.ti.com/computers</a>
Consumer Electronics	<a href="http://www.ti.com/consumer-apps">www.ti.com/consumer-apps</a>
Energy and Lighting	<a href="http://www.ti.com/energy">www.ti.com/energy</a>
Industrial	<a href="http://www.ti.com/industrial">www.ti.com/industrial</a>
Medical	<a href="http://www.ti.com/medical">www.ti.com/medical</a>
Security	<a href="http://www.ti.com/security">www.ti.com/security</a>
Space, Avionics and Defense	<a href="http://www.ti.com/space-avionics-defense">www.ti.com/space-avionics-defense</a>
Transportation and Automotive	<a href="http://www.ti.com/automotive">www.ti.com/automotive</a>
Video and Imaging	<a href="http://www.ti.com/video">www.ti.com/video</a>

TI E2E Community Home Page

[e2e.ti.com](http://e2e.ti.com)

Mailing Address: Texas Instruments, Post Office Box 655303, Dallas, Texas 75265  
Copyright © 2011, Texas Instruments Incorporated