

CLC440

CLC440 High Speed, Low Power, Voltage Feedback Op Amp



Literature Number: SNOS826B

CLC440

High Speed, Low Power, Voltage Feedback Op Amp

General Description

The CLC440 is a wideband, low power, voltage feedback op amp that offers 750MHz unity-gain bandwidth, 1500V/ μ s slew rate, and 90mA output current. For video applications, the CLC440 sets new standards for voltage feedback monolithics by offering the impressive combination of 0.015% differential gain and 0.025° differential phase errors while dissipating a mere 70mW.

The CLC440 incorporates the proven properties of Comlinear's current feedback amplifiers (high bandwidth, fast slewing, etc.) into a "classical" voltage feedback architecture. This amplifier possesses truly differential and fully symmetrical inputs both having a high 900k Ω impedance with matched low input bias currents. Furthermore, since the CLC440 incorporates voltage feedback, a specific R_f is not required for stability. This flexibility in choosing R_f allows for numerous applications in wideband filtering and integration.

Unlike several other high speed voltage feedback op amps, the CLC440 operates with a wide range of dual or single supplies allowing for use in a multitude of applications with limited supply availability. The CLC440's low 3.5nV/ $\sqrt{\text{Hz}}$ (e_n) and 2.5pA/ $\sqrt{\text{Hz}}$ (i_n) noise sets a very low noise floor.

Features

- Unity-gain stable
- High unity-gain bandwidth: 750MHz
- Ultra low differential gain: 0.015%
- Very low differential phase: 0.025°
- Low power: 70mW
- Extremely fast slew rate: 1500V/ μ s
- High output current: 90mA

- Low noise: 3.5nV/ $\sqrt{\text{Hz}}$
- Dual $\pm 2.5\text{V}$ to $\pm 6\text{V}$ or single 5V to 12V supplies

Applications

- Professional video
- Graphics workstations
- Test equipment
- Video switching & routing
- Communications
- Medical imaging
- A/D drivers
- Photo diode transimpedance amplifiers
- Improved replacement for CLC420 or OPA620

Frequency Response ($A_v = +2\text{V/V}$)

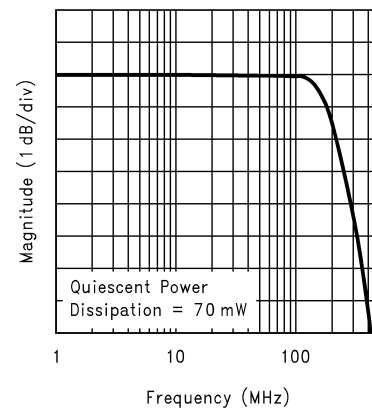

Generator Waveforms

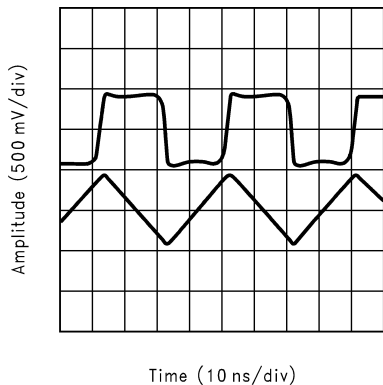

Connection Diagram

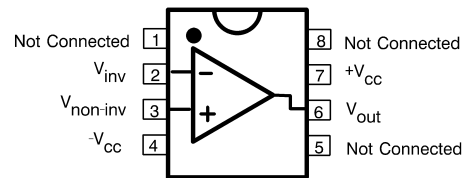

Pinout
DIP & SOIC

DS012714-26

Typical Application

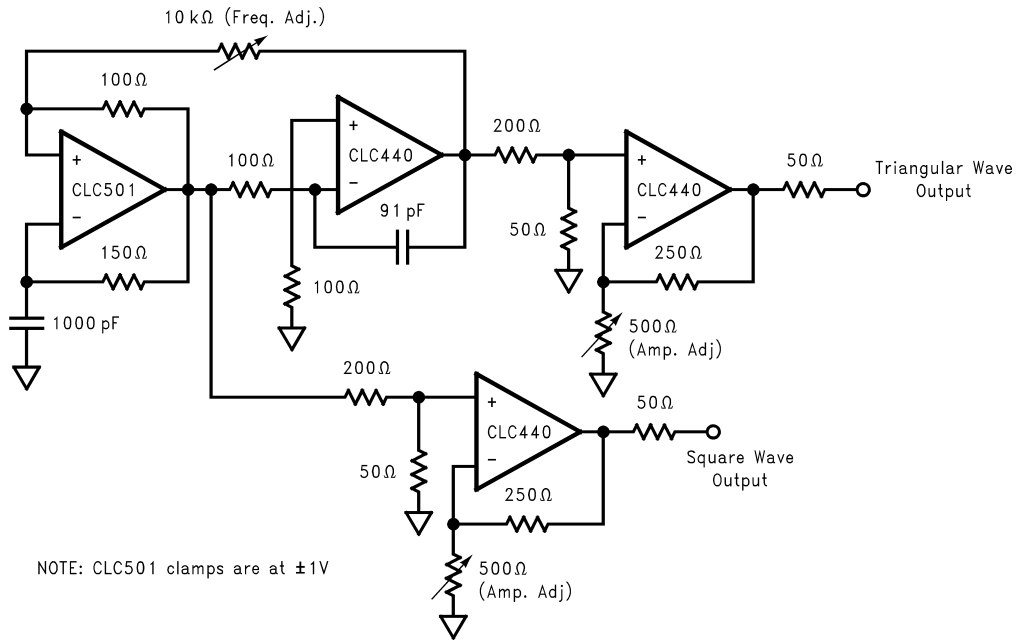

DS012714-2

Ordering Information

Package	Temperature Range Industrial	Part Number	Package Marking	NSC Drawing
8-pin plastic DIP	-40°C to +85°C	CLC440AJP	CLC440AJP	N08E
8-pin plastic SOIC	-40°C to +85°C	CLC440AJE	CLC440AJE	M08A

Absolute Maximum Ratings (Note 1)

If Military/Aerospace specified devices are required, please contact the National Semiconductor Sales Office/Distributors for availability and specifications.

Supply Voltage (V_{CC})	$\pm 6V$
I_{OUT} is short circuit protected to ground	
Common Mode Input Voltage	$\pm V_{CC}$
Maximum Junction Temperature	$+150^{\circ}C$
Storage Temperature Range	$-65^{\circ}C$ to $+150^{\circ}C$

Lead Temperature (soldering, 10 sec)

 $+300^{\circ}C$

ESD rating (human body model)

 $<1000V$ **Operating Ratings**

Thermal Resistance		
Package	(θ_{JC})	(θ_{JA})
MDIP	$70^{\circ}C/W$	$125^{\circ}C/W$
SOIC	$60^{\circ}C/W$	$140^{\circ}C/W$

Electrical Characteristics

$A_V = +2$, $R_f = R_g = 250\Omega$; $V_{CC} = \pm 5V$, $R_L = 100\Omega$ unless specified.

Symbol	Parameter	Conditions	Typ	Min/Max (Note 2)			Units
Ambient Temperature		CLC440IN	$+25^{\circ}C$	$+25^{\circ}C$	0 to $70^{\circ}C$	-40 to $85^{\circ}C$	
Frequency Domain Response							
	-3dB Bandwidth $A_V = +2$	$V_{OUT} < 0.2V_{PP}$	260	165	165	135	MHz
		$V_{OUT} < 4.0V_{PP}$	190	150	135	130	MHz
	-3dB Bandwidth $A_V = +1$	$V_{OUT} < 0.2V_{PP}$	750				MHz
	Gain Bandwidth Product	$V_{OUT} < 0.2V_{PP}$	230				MHz
	Gain Flatness	$V_{OUT} < 2.0V_{PP}$, DC to 75MHz	0.05	0.15	0.20	0.20	dB
	Linear Phase Deviation	$V_{OUT} < 2.0V_{PP}$, DC to 75MHz	0.8	1.2	1.5	1.5	deg
	Differential Gain	$R_L = 150\Omega$, 4.43MHz	0.015	0.03	0.04	0.04	%
	Differential Phase	$R_L = 150\Omega$, 4.43MHz	0.025	0.05	0.06	0.06	deg
Time Domain Response							
	Rise and Fall Time	2V step	1.5	2.0	2.2	2.5	ns
		4V step	3.2	4.2	4.5	5.0	ns
	Settling Time to $\pm 0.05\%$	2V step	10	14	16	16	ns
	Overshoot	4V step	7	13	13	13	%
	Slew Rate	4V step, $\pm 0.5V$ crossing	1500	900	750	600	V/ μs
Distortion And Noise Response							
	2nd Harmonic Distortion	$2V_{PP}$, 5MHz	-64	-59	-59	-59	dBc
		$2V_{PP}$, 20MHz	-52	-46	-46	-46	dBc
	3rd Harmonic Distortion	$2V_{PP}$, 5MHz	-70	-65	-64	-64	dBc
		$2V_{PP}$, 20MHz	-51	-45	-43	-43	dBc
	Equivalent Input Noise						
	Voltage	$>1MHz$	3.5	4.5	5.0	5.0	nV/\sqrt{Hz}
	Current	$>1MHz$	2.5	3.5	4.0	4.0	pA/\sqrt{Hz}
Static DC Performance							
	Input Offset Voltage (Note 3)		1.0	3.0	3.5	4.0	mV
	Average Drift		5.0	-	10	10	$\mu V/^{\circ}C$
	Input Bias Current (Note 3)		10	30	35	40	μA
	Average Drift		30	-	50	60	$nA/^{\circ}C$
	Input Offset Current (Note 3)		0.5	2.0	2.0	3.0	μA
	Average Drift		3.0	-	10	10	$nA/^{\circ}C$
	Power Supply Rejection Ratio	DC	65	58	58	58	dB
	Common Mode Rejection Ratio	DC	80	65	60	60	dB
	Supply Current (Note 3)	$R_L = \infty$	7.0	7.5	8.0	8.0	mA
Miscellaneous Performance							
	Input Resistance	Common-Mode	900	500	400	300	$k\Omega$

Electrical Characteristics (Continued)

$A_V = +2$, $R_f = R_g = 250\Omega$; $V_{CC} = \pm 5V$, $R_L = 100\Omega$ unless specified.

Symbol	Parameter	Conditions	Typ	Min/Max (Note 2)				Units
Miscellaneous Performance								
	Input Capacitance	Common-Mode	1.2	2.0	2.0	2.0	2.0	pF
		Differential-Mode	0.5	1.0	1.0	1.0	1.0	pF
	Input Voltage Range	Common-Mode	± 3.0	± 2.8	± 2.7	± 2.7	± 2.7	V
	Output Voltage Range	$R_L = 100\Omega$	± 2.5	± 2.3	± 2.2	± 2.2	± 2.2	V
	Output Voltage Range	$R_L = \infty$	± 3.0	± 2.8	± 2.7	± 2.7	± 2.7	V
	Output Current		± 80	± 72	± 65	± 45	± 45	mA

Note 1: "Absolute Maximum Ratings" are those values beyond which the safety of the device cannot be guaranteed. They are not meant to imply that the devices should be operated at these limits. The table of "Electrical Characteristics" specifies conditions of device operation.

Note 2: Min/max ratings are based on product characterization and simulation. Individual parameters are tested as noted. Outgoing quality levels are determined from tested parameters.

Note 3: AJ-level: spec. is 100% tested at +25°C.

Typical Performance Characteristics

Non-Inverting Frequency Response

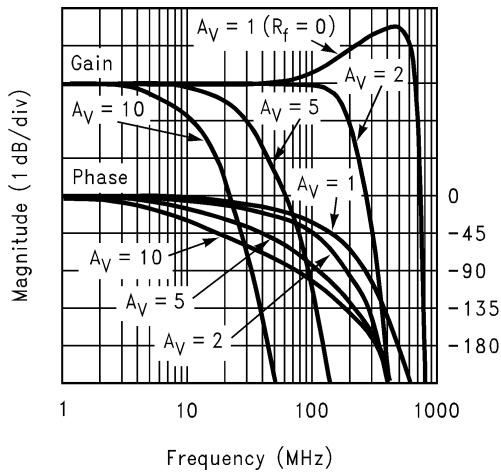

DS012714-3

Inverting Frequency Response

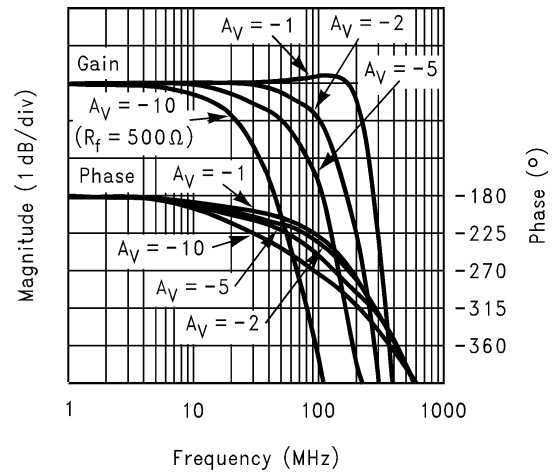

DS012714-4

Frequency Response vs. Load

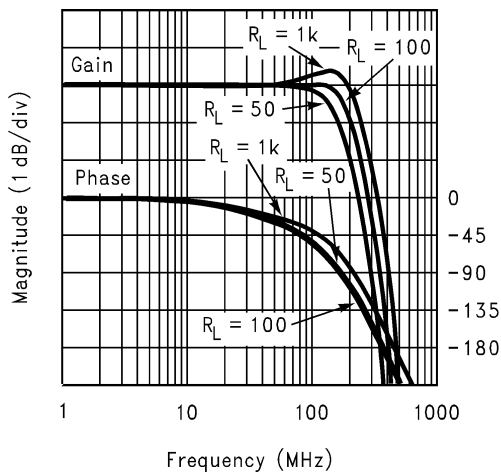

DS012714-5

Frequency Response vs. VOUT

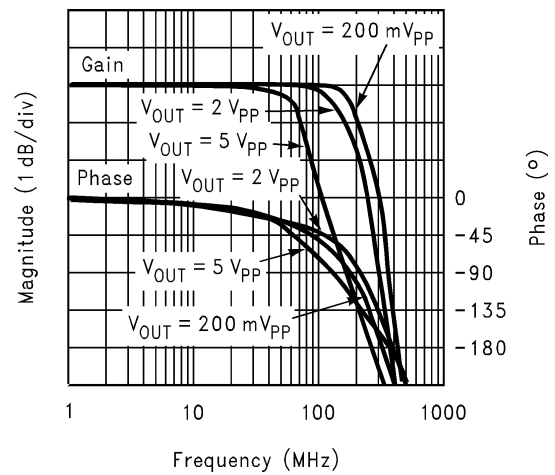

DS012714-6

Typical Performance Characteristics (Continued)

Frequency Response vs. Capacitive Load

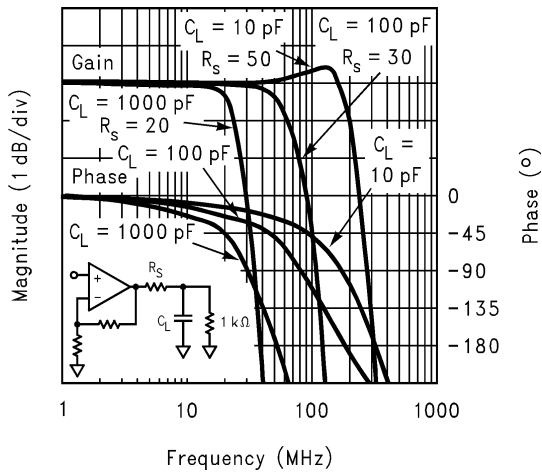

DS012714-7

Gain Flatness and Linear Phase

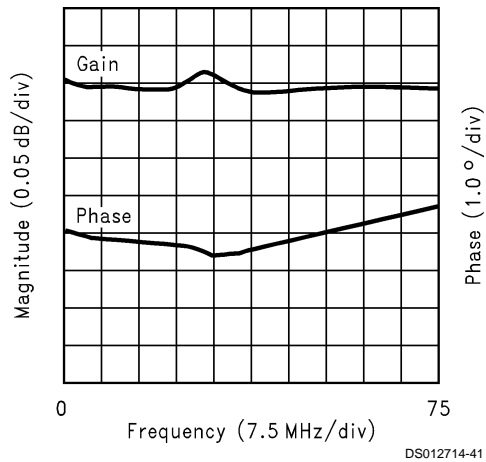

DS012714-41

Open Loop Gain and Phase

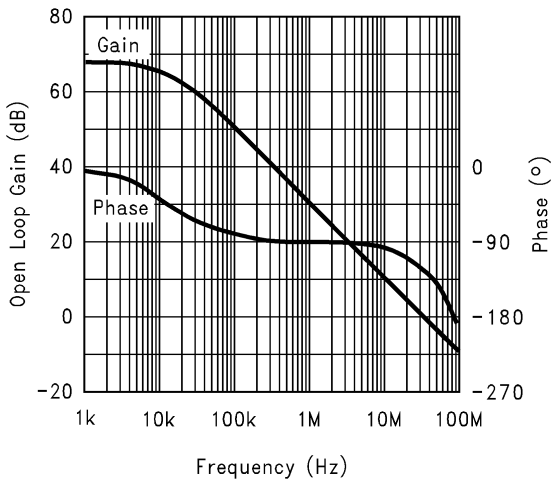

DS012714-8

BW vs. Gain for Transimpedance Configuration

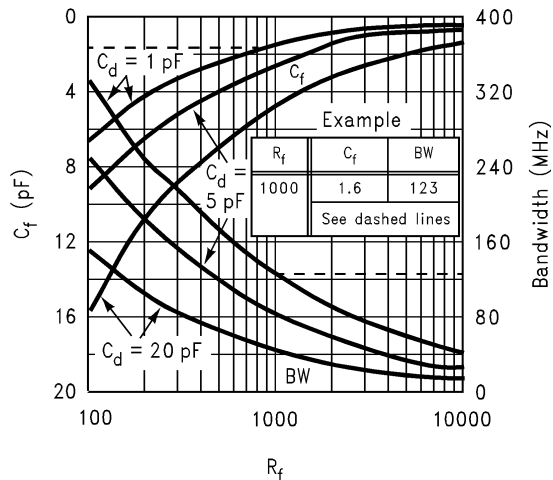

DS012714-9

Equivalent Input Noise

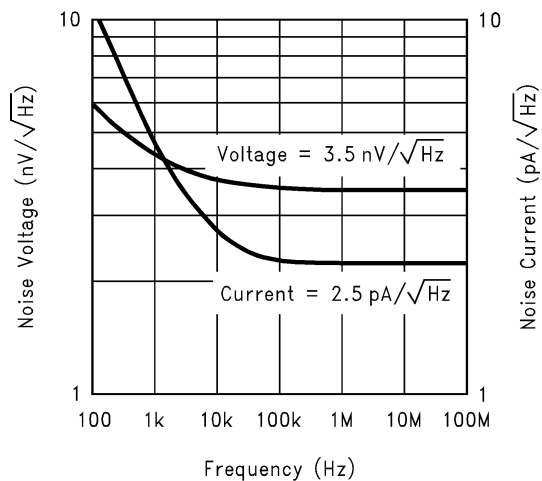

DS012714-10

Harmonic Distortion vs. Frequency

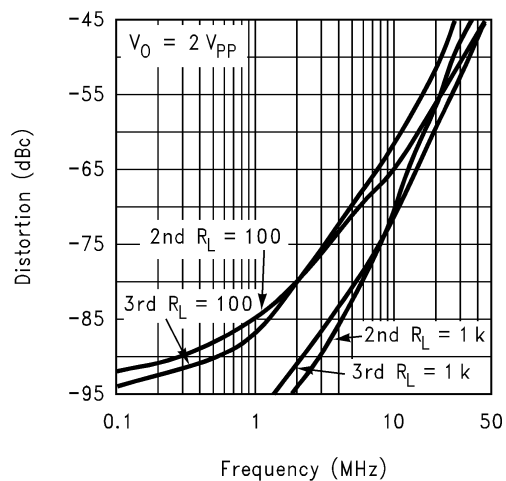

DS012714-11

Typical Performance Characteristics (Continued)

1dB Compression

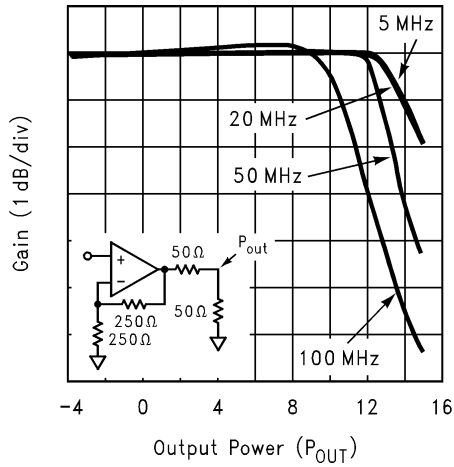

PSRR, CMRR, and Closed Loop R_{OUT}

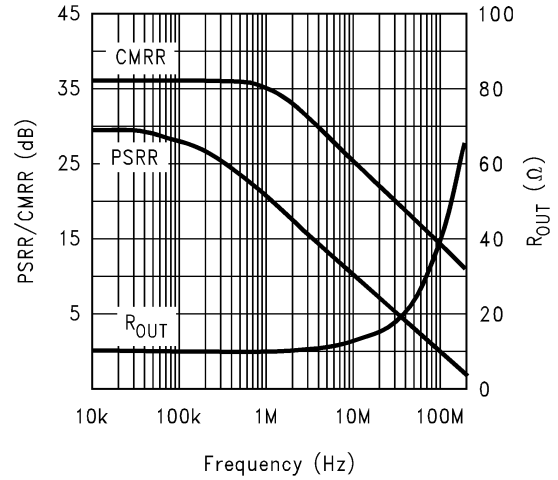

Input and Output VSWR

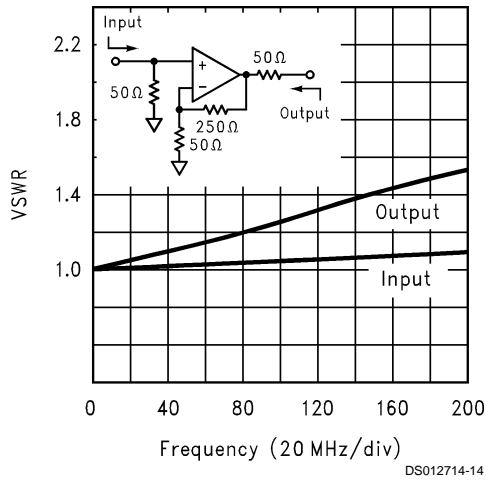

2-Tone, 3rd Order Intermodulation Intercept

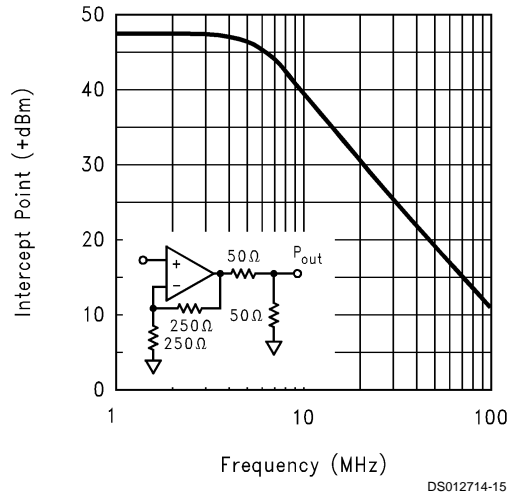

Differential Gain and Phase

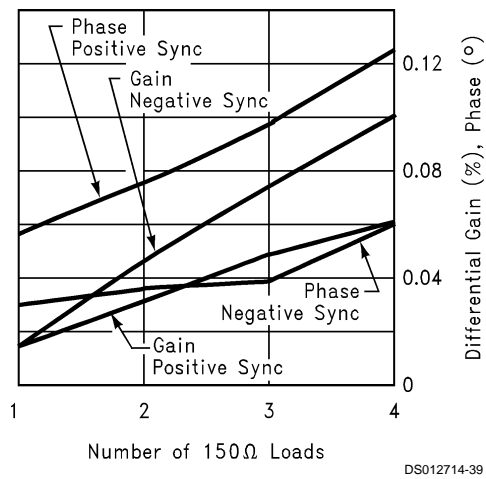

Pulse Response

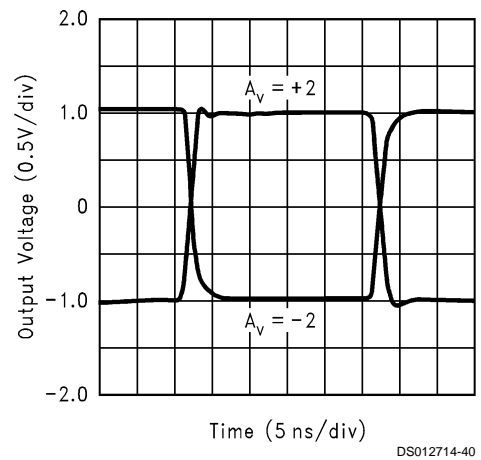

Typical Performance Characteristics (Continued)

Typical DC Errors vs. Temperature

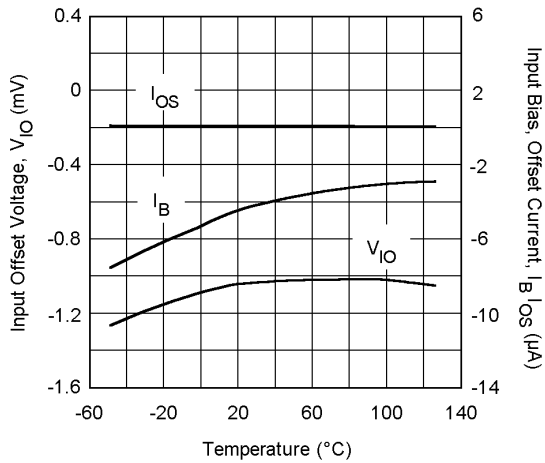

DS012714-45

0.05% Settling Time vs. Capacitive Load

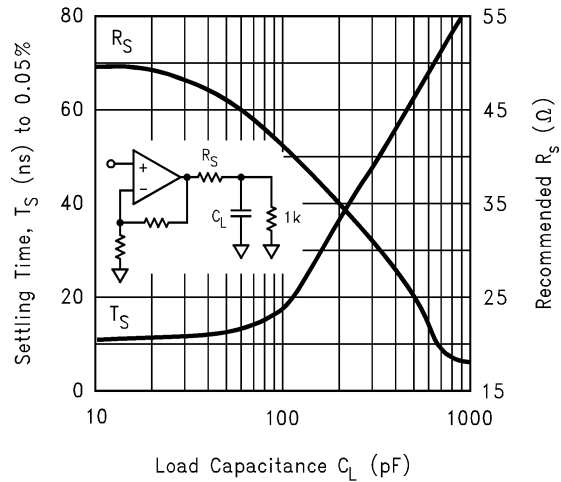

DS012714-16

Short Term Settling Time

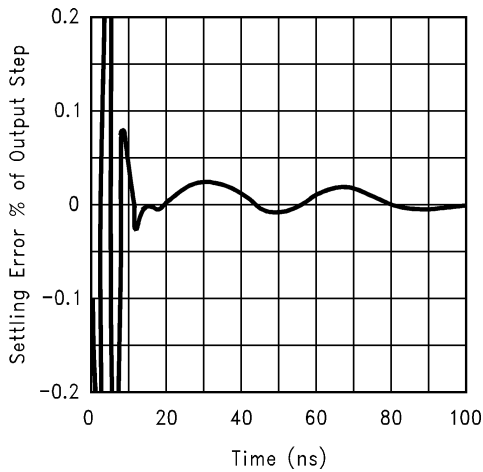

DS012714-21

Long Term Settling Time

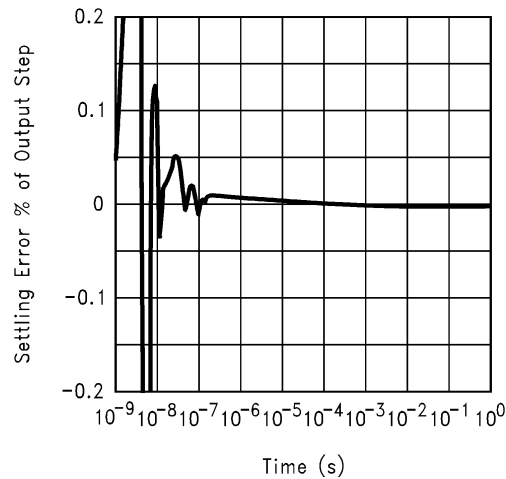

DS012714-22

IB and IOS vs. Common-Mode Voltage

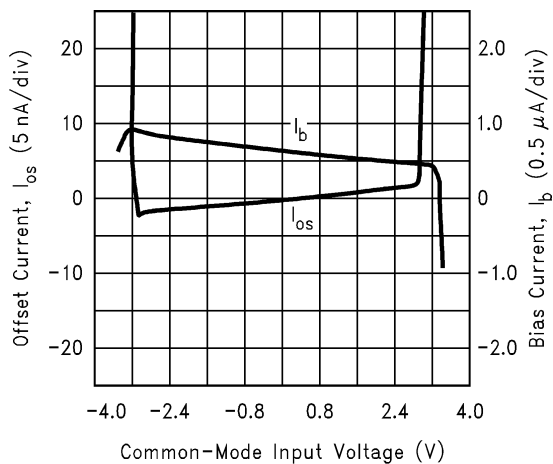

DS012714-23

Application Division

General Design Equations

The CLC440 is a unity gain stable voltage feedback amplifier. The matched input bias currents track well over temperature. This allows the DC offset to be minimized by matching the impedance seen by both inputs.

Gain

The non-inverting and inverting gain equations for the CLC440 are as follows:

$$\text{NON-INVERTING GAIN: } 1 + \frac{R_f}{R_g}$$

$$\text{INVERTING GAIN: } -\frac{R_f}{R_g}$$

Gain Bandwidth Product

The CLC440 is a voltage feedback amplifier, whose closed-loop bandwidth is approximately equal to the gain-bandwidth product (GBP) divided by the gain (A_V). For gains greater than 5, A_V sets the closed-loop bandwidth of the CLC440.

$$\text{CLOSE LOOP BANDWIDTH} = \frac{\text{GBP}}{A_V}$$

$$A_V = \frac{(R_f = R_g)}{R_g}$$

$$\text{GBP} = 230\text{MHz}$$

For gains less than 5, refer to the frequency response plots to determine maximum bandwidth.

Output Drive and Settling Time Performance

The CLC440 has large output current capability. The 90mA of output current makes the CLC440 an excellent choice for applications such as:

- Video Line Drivers
- Distribution Amplifiers

When driving a capacitive load or coaxial cable, include a series resistance R_s to back match or improve settling time. Refer to the "Settling Time vs. Capacitive Load" plot in the typical performance section to determine the recommended resistance for various capacitive loads.

When driving resistive loads of under 500Ω, settling time performance diminishes. This degradation occurs because a small change in voltage on the output causes a large change of current in the power supplies. This current creates ringing on the power supplies. A small resistor will dampen this effect if placed in series with 6.8μF bypass capacitor.

Noise Figure

Noise Figure (NF) is a measure of noise degradation caused by an amplifier.

$$\text{NF} = 10\text{LOG} \left[\frac{S_i/N_i}{S_o/N_o} \right] = 10\text{LOG} \left[\frac{e_{ni}^2}{e_t^2} \right]$$

where,

e_{ni} = Total Equivalent Input Noise Density Due to the Amplifier

e_t = Thermal Voltage Noise ($\sqrt{4kTR_{seq}}$)

Figure 1 shows the noise model for the non-inverting amplifier configuration. The model includes all of the following noise sources:

- Input voltage noise (e_n)
- Input current noise ($i_n = i_{n+} = i_{n-}$)
- Thermal Voltage Noise (e_t) associated with each external resistor

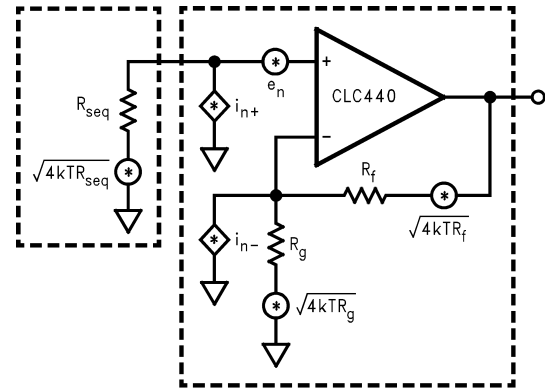

$$R_{seq} = R_s \text{ for Unterminated Systems}$$

$$R_{seq} = R_s \parallel R_T \text{ for Terminated Systems}$$

DS012714-30

FIGURE 1. Non-Inverting Amplifier Noise Model

The total equivalent input noise density is calculated by using the noise model shown. Equations 1 and 2 represent the noise equation and the resulting equation for noise figure.

$$e_{ni} = \sqrt{e_n^2 + i_n^2 \left(R_{seq}^2 + (R_f \parallel R_g)^2 \right) + 4kTR_{seq} + 4kT(R_f \parallel R_g)} \quad (1)$$

$$\text{NF} = 10\text{LOG} \left(\frac{e_n^2 + i_n^2 \left(R_{seq}^2 + (R_f \parallel R_g)^2 \right) + 4kTR_{seq} + 4kT(R_f \parallel R_g)}{4kTR_{seq}} \right) \quad (2)$$

The noise figure is related to the equivalent source resistance (R_{seq}) and the parallel combination of R_f and R_g . To minimize noise figure, the following steps are recommended:

- Minimize $R_f \parallel R_g$
- Choose the optimum R_s (R_{OPT})
- R_{OPT} is the point at which the NF curve reaches a minimum and is approximated by:

$$R_{OPT} \cong \frac{e_n}{i_n}$$

Figure 2 is a plot of NF vs. R_s with $R_f = 0$, $R_g = \infty$ ($A_V = +1$). The NF curves for both Unterminated and Terminated systems are shown. The Terminated curve assumes $R_s = R_T$. The table indicates the NF for various source resistances including $R_s = R_{OPT}$.

Application Division (Continued)

Layout Considerations

A proper printed circuit layout is essential for achieving high frequency performance. National provides evaluation boards for the CLC440 (CLC730055-DIP, CLC730060-SOIC) and suggests their use as a guide for high frequency layout and as an aid in device testing and characterization.

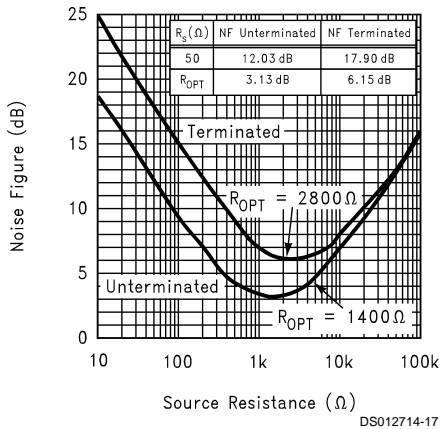

FIGURE 2. Noise Figure vs. Source Resistance

These boards were laid out for optimum, high-speed performance. The ground plane was removed near the input and output pins to reduce parasitic capacitance. And all trace lengths were minimized to reduce series inductances.

Supply bypassing is required for the amplifiers performance. The bypass capacitors provide a low impedance return current path at the supply pins. They also provide high frequency filtering on the power supply traces. 6.8 μ F tantalum, 0.01 μ F ceramic, and 500pF ceramic capacitors are recommended on both supplies. Place the 6.8 μ F capacitors within 0.75 inches of the power pins, and the 0.01 μ F and 500pF capacitors less than 0.1 inches from the power pins.

Dip sockets add parasitic capacitance and inductance which can cause peaking in the frequency response and overshoot in the time domain response. If sockets are necessary, flush-mount socket pins are recommended. The device holes in the 730055 evaluation board are sized for Cambion P/N 450-2598 socket pins, or their functional equivalent.

Transimpedance Amplifier

The low 2.5pA/ $\sqrt{\text{Hz}}$ input current noise and unity gain stability make the CLC440 an excellent choice for transimpedance applications. Figure 3 illustrates a low noise transimpedance amplifier that is commonly implemented with photo diodes. R_f sets the transimpedance gain. The photo diode current multiplied by R_f determines the output voltage.

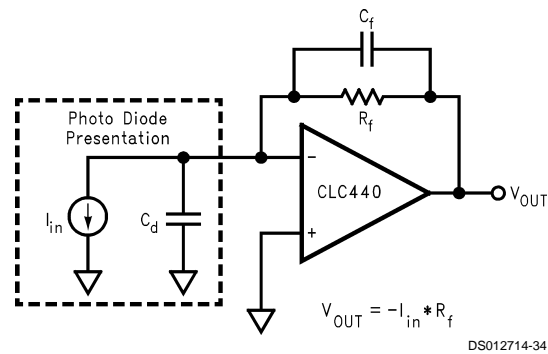

FIGURE 3. Transimpedance Amplifier Configuration

The capacitances are defined as:

- C_{in} = Internal Input Capacitance of the CLC440 (typ 1.2pF)
- C_d = Equivalent Diode Capacitance
- C_f = Feedback Capacitance

The transimpedance plot in the typical performance section provides the recommended C_f and expected bandwidth for different gains and diode capacitances. The feedback capacitances indicated on the plot give optimum gain flatness and stability. If a smaller capacitance is used, then peaking will occur. The frequency response shown in Figure 4 illustrates the influence of the feedback capacitance on gain flatness.

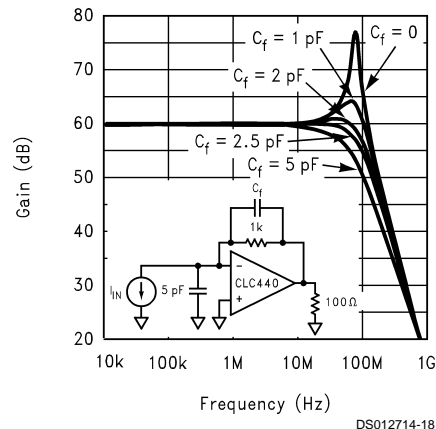

FIGURE 4. Transimpedance Amplifier Frequency Response

The total input current noise density (i_{ni}) for the basic transimpedance configuration is shown in Equation 3. The plot of current noise density versus feedback resistance is shown in Figure 5.

Application Division (Continued)

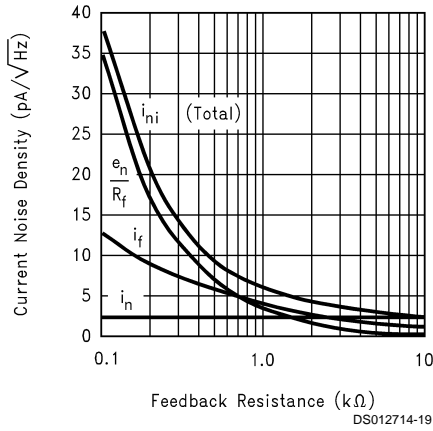
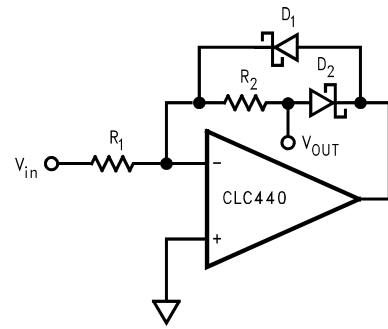

FIGURE 5. Current Noise Density vs. Feedback Resistance

$$i_{ni} = \sqrt{i_n + \left[\frac{e_n}{R_f} \right]^2 + \frac{4kT}{R_f}} \quad (3)$$

Rectifier

The large bandwidth of the CLC440 allows for high speed rectification. A common rectifier topology is shown in Figure 6. R_1 and R_2 set the gain of the rectifier. V_{OUT} for a 5MHz, 2V_{pp} sinusoidal input is shown in Figure 7.



DS012714-36

FIGURE 6. Rectifier Topology

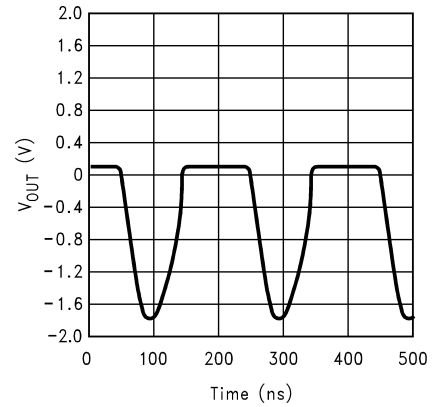
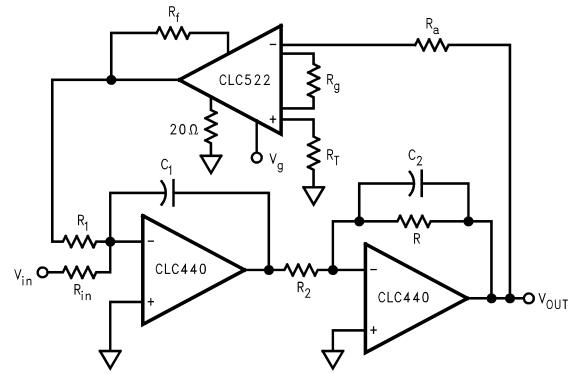

FIGURE 7. Rectifier Output

Tunable Low Pass Filter

The center frequency of the low pass filter (LPF) can be adjusted by varying the CLC522 gain control voltage, V_g .



$$\omega_o = \sqrt{\frac{k}{R_1 R_2 C_1 C_2}} \quad Q = \sqrt{k} \left(\frac{RC_2}{\sqrt{R_1 R_2 C_1 C_2}} \right) \quad R_g = \frac{V_{in(max)}}{1.8 \text{ mA}} \quad A_v(max) = k = 1.85 \frac{R_f}{R_g}$$

DS012714-38

FIGURE 8. Tunable Low Pass Filter

Physical Dimensions inches (millimeters) unless otherwise noted

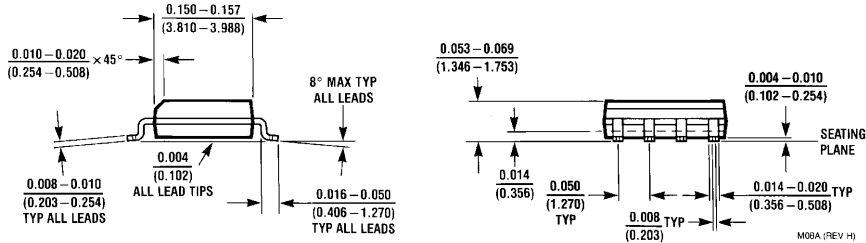
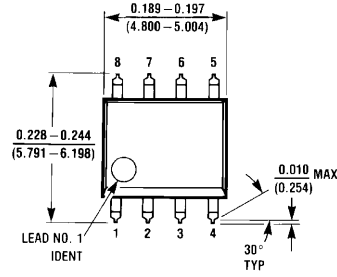

8-Pin SOIC
NS Package Number M08A

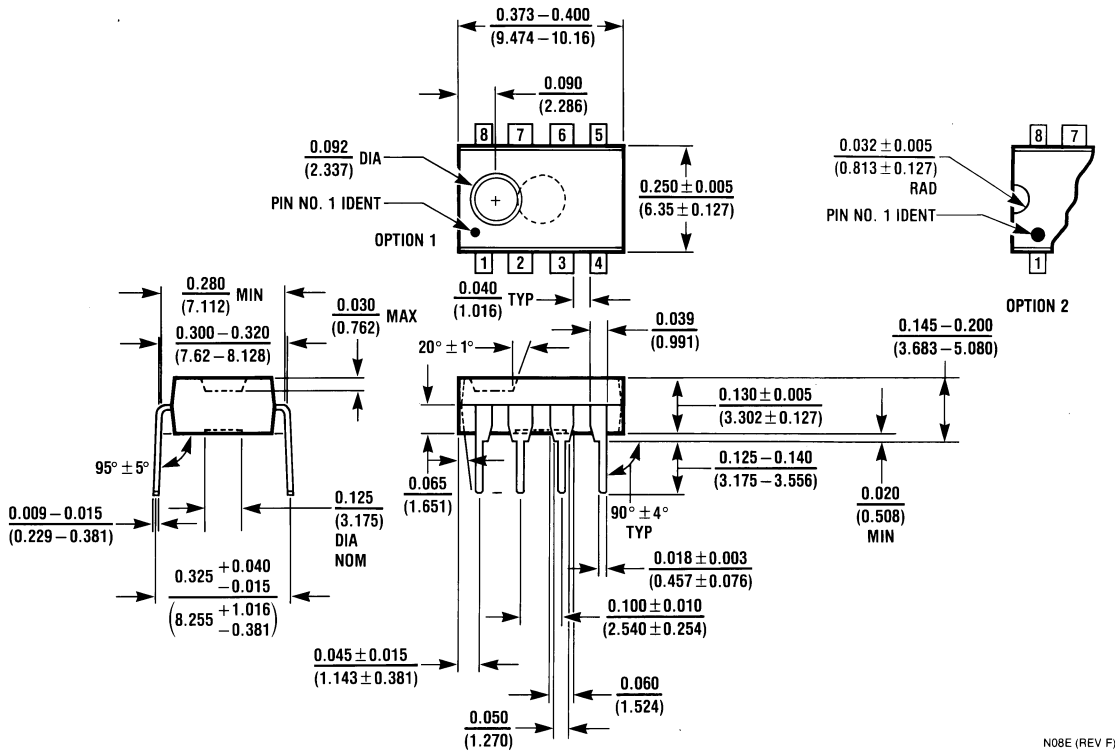

8-Pin MDIP
NS Package Number N08E

Notes

LIFE SUPPORT POLICY

NATIONAL'S PRODUCTS ARE NOT AUTHORIZED FOR USE AS CRITICAL COMPONENTS IN LIFE SUPPORT DEVICES OR SYSTEMS WITHOUT THE EXPRESS WRITTEN APPROVAL OF THE PRESIDENT AND GENERAL COUNSEL OF NATIONAL SEMICONDUCTOR CORPORATION. As used herein:

1. Life support devices or systems are devices or systems which, (a) are intended for surgical implant into the body, or (b) support or sustain life, and whose failure to perform when properly used in accordance with instructions for use provided in the labeling, can be reasonably expected to result in a significant injury to the user.
2. A critical component is any component of a life support device or system whose failure to perform can be reasonably expected to cause the failure of the life support device or system, or to affect its safety or effectiveness.



National Semiconductor Corporation
Americas
Tel: 1-800-272-9959
Fax: 1-800-737-7018
Email: support@nsc.com
www.national.com

National Semiconductor Europe
Fax: +49 (0) 180-530 85 86
Email: europe.support@nsc.com
Deutsch Tel: +49 (0) 69 9508 6208
English Tel: +44 (0) 870 24 0 2171
Français Tel: +33 (0) 1 41 91 8790

National Semiconductor Asia Pacific Customer Response Group
Tel: 65-2544466
Fax: 65-2504466
Email: ap.support@nsc.com

National Semiconductor Japan Ltd.
Tel: 81-3-5639-7560
Fax: 81-3-5639-7507

IMPORTANT NOTICE

Texas Instruments Incorporated and its subsidiaries (TI) reserve the right to make corrections, modifications, enhancements, improvements, and other changes to its products and services at any time and to discontinue any product or service without notice. Customers should obtain the latest relevant information before placing orders and should verify that such information is current and complete. All products are sold subject to TI's terms and conditions of sale supplied at the time of order acknowledgment.

TI warrants performance of its hardware products to the specifications applicable at the time of sale in accordance with TI's standard warranty. Testing and other quality control techniques are used to the extent TI deems necessary to support this warranty. Except where mandated by government requirements, testing of all parameters of each product is not necessarily performed.

TI assumes no liability for applications assistance or customer product design. Customers are responsible for their products and applications using TI components. To minimize the risks associated with customer products and applications, customers should provide adequate design and operating safeguards.

TI does not warrant or represent that any license, either express or implied, is granted under any TI patent right, copyright, mask work right, or other TI intellectual property right relating to any combination, machine, or process in which TI products or services are used. Information published by TI regarding third-party products or services does not constitute a license from TI to use such products or services or a warranty or endorsement thereof. Use of such information may require a license from a third party under the patents or other intellectual property of the third party, or a license from TI under the patents or other intellectual property of TI.

Reproduction of TI information in TI data books or data sheets is permissible only if reproduction is without alteration and is accompanied by all associated warranties, conditions, limitations, and notices. Reproduction of this information with alteration is an unfair and deceptive business practice. TI is not responsible or liable for such altered documentation. Information of third parties may be subject to additional restrictions.

Resale of TI products or services with statements different from or beyond the parameters stated by TI for that product or service voids all express and any implied warranties for the associated TI product or service and is an unfair and deceptive business practice. TI is not responsible or liable for any such statements.

TI products are not authorized for use in safety-critical applications (such as life support) where a failure of the TI product would reasonably be expected to cause severe personal injury or death, unless officers of the parties have executed an agreement specifically governing such use. Buyers represent that they have all necessary expertise in the safety and regulatory ramifications of their applications, and acknowledge and agree that they are solely responsible for all legal, regulatory and safety-related requirements concerning their products and any use of TI products in such safety-critical applications, notwithstanding any applications-related information or support that may be provided by TI. Further, Buyers must fully indemnify TI and its representatives against any damages arising out of the use of TI products in such safety-critical applications.

TI products are neither designed nor intended for use in military/aerospace applications or environments unless the TI products are specifically designated by TI as military-grade or "enhanced plastic." Only products designated by TI as military-grade meet military specifications. Buyers acknowledge and agree that any such use of TI products which TI has not designated as military-grade is solely at the Buyer's risk, and that they are solely responsible for compliance with all legal and regulatory requirements in connection with such use.

TI products are neither designed nor intended for use in automotive applications or environments unless the specific TI products are designated by TI as compliant with ISO/TS 16949 requirements. Buyers acknowledge and agree that, if they use any non-designated products in automotive applications, TI will not be responsible for any failure to meet such requirements.

Following are URLs where you can obtain information on other Texas Instruments products and application solutions:

Products

Audio	www.ti.com/audio
Amplifiers	amplifier.ti.com
Data Converters	dataconverter.ti.com
DLP® Products	www.dlp.com
DSP	dsp.ti.com
Clocks and Timers	www.ti.com/clocks
Interface	interface.ti.com
Logic	logic.ti.com
Power Mgmt	power.ti.com
Microcontrollers	microcontroller.ti.com
RFID	www.ti-rfid.com
OMAP Mobile Processors	www.ti.com/omap
Wireless Connectivity	www.ti.com/wirelessconnectivity

Applications

Communications and Telecom	www.ti.com/communications
Computers and Peripherals	www.ti.com/computers
Consumer Electronics	www.ti.com/consumer-apps
Energy and Lighting	www.ti.com/energy
Industrial	www.ti.com/industrial
Medical	www.ti.com/medical
Security	www.ti.com/security
Space, Avionics and Defense	www.ti.com/space-avionics-defense
Transportation and Automotive	www.ti.com/automotive
Video and Imaging	www.ti.com/video

TI E2E Community Home Page

e2e.ti.com

Mailing Address: Texas Instruments, Post Office Box 655303, Dallas, Texas 75265
Copyright © 2011, Texas Instruments Incorporated