

CLC415

CLC415 Quad, Wideband Monolithic Op Amp



Literature Number: SNOS856D

CLC415

Quad, Wideband Monolithic Op Amp

General Description

The CLC415 is a wideband, quad, monolithic operational amplifier designed for intermediate gain applications where power and cost per channel of are primary concern. Benefiting from **National's** current feedback architecture, the CLC415 offers a gain range of ± 1 to ± 10 while providing stable, oscillation free operation without external compensation, even at unity gain.

Operating from $\pm 5V$ supplies, the CLC415 consumes only 50mW of power per channel, yet maintains a 160MHz small-signal bandwidth and a 1500V/ μ s slew rate. High density applications requiring an integrated solution will enjoy the CLC415's 70dB channel isolation (input referred @ 5MHz).

With its exceptional differential gain and phase, typically 0.03% and 0.03° @ 3.58MHz, the CLC415 is designed to meet the performance and cost per channel requirements of high volume composite video applications. The CLC415's large-signal bandwidth, high slew rate and high drive capability are features well suited for RGB-video applications.

The CLC415 is a quad version of the high speed CLC406 while the CLC414 is a lower power quad version of the same. Both of these quads afford the designer lower power consumption and lower cost per channel with the additional benefit of requiring less board space per amplifier.

Constructed using an advanced, complementary bipolar process and **National's** proven current feedback architectures. The CLC415 is available in several versions to meet a variety of requirements.

Enhanced Solutions (Military/Aerospace)

SMD Number: 5962-93055

Space level versions also available.

For more information, visit <http://www.national.com/mil>

Features

- 160MHz small signal bandwidth
- 5mA quiescent current per amplifier
- 70dB channel isolation @ 5MHz
- 0.03%/0.03° differential gain/phase
- 12ns settling to 0.1%
- 1500V/ μ s slew rate
- 2.0ns rise and fall time ($2V_{PP}$)
- 60mA output current per amplifier

Applications

- Composite video distribution amps
- HDTV amplifiers
- RGB-video amplifiers
- CCD signal processing
- Active Filters
- Instrumentation differential amps
- Channelized EW

Small Signal Pulse Response

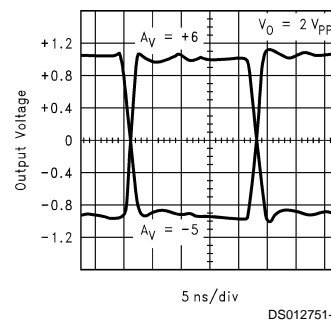

Non-Inverting Frequency Response

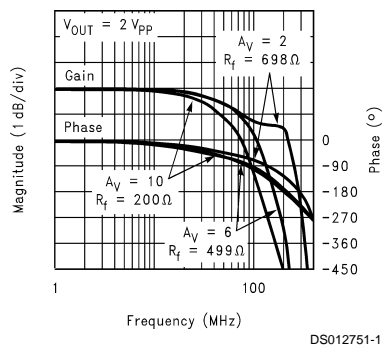

Connection Diagram

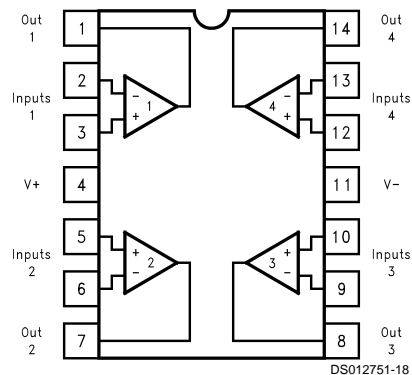

Ordering Information

Package	Temperature Range Industrial	Part Number	Package Marking	NSC Drawing
14-pin plastic DIP	-40°C to +85°C	CLC415AJP	CLC415AJP	N14A
14-pin plastic SOIC	-40°C to +85°C	CLC415AJE	CLC415AJE	M14A

Absolute Maximum Ratings (Note 1)

If Military/Aerospace specified devices are required, please contact the National Semiconductor Sales Office/Distributors for availability and specifications.

Supply Voltage (V_{CC})	$\pm 7V$
I_{OUT}	60mA
Output is short circuit protected to ground, but maximum reliability will be maintained if I_{OUT} does not exceed...	
Common Mode Input Voltage	$\pm V_{CC}$
Differential Input Voltage	$\pm 10V$
Maximum Junction Temperature	+150°C

Operating Temperature Range	-40°C to +85°C
Storage Temperature Range	-65°C to +150°C
Lead Temperature (Soldering 10 sec)	+300°C
ESD Rating (Human Body Model)	<1000V

Operating Ratings

Thermal Resistance			
Package	(θ_{JC})	(θ_{JA})	
MDIP	55°C/W	105°C/W	
SOIC	45°C/W	115°C/W	

Electrical Characteristics

($A_V = +6$, $V_{CC} = \pm 5V$, $R_L = 100\Omega$, $R_f = 500\Omega$; Unless Specified)

Symbol	Parameter	Conditions	Typ	Max/Min (Note 2)			Units
Ambient Temperature		CLC415AJ	+25°C	+25°C	-40°C	+85°C	
Frequency Domain Response							
SSBW	-3dB Bandwidth	$V_{OUT} < 2V_{PP}$	160	>120	>120	>90	MHz
LSBW		$V_{OUT} < 5V_{PP}$	120	>85	>90	>80	MHz
	Gain Flatness	$V_{OUT} < 2V_{PP}$					
GFPL	Peaking	DC to 25MHz	0	<0.2	<0.2	<0.2	dB
GFPH	Peaking	>25MHz	0	<0.5	<0.5	<0.5	dB
GFR	Rolloff	DC to 50MHz	0.2	<0.7	<0.7	<1.1	dB
LPD	Linear Phase Deviation	DC to 75MHz	0.5	<1.0	<1.0	<1.3	deg
DG1	Differential Gain ($A_V = +2$)	150 Ω Load, 3.58MHz	0.03	<0.08	<0.08	<0.08	%
DG2		150 Ω Load, 4.43MHz	0.03	<0.10	<0.10	<0.10	%
DP1	Differential Phase ($A_V = +2$)	150 Ω Load, 3.58MHz	0.03	<0.08	<0.08	<0.08	deg
DP2		150 Ω Load, 4.43MHz	0.03	<0.10	<0.10	<0.10	deg
XT	Crosstalk Input Referred	5MHz (All Hostile)	65	<60	<60	<59	dB
CXT	Crosstalk Input Referred	5MHz (Chan. to Chan.)	70	<63	<63	<62	dB
Time Domain Response							
TRS	Rise and Fall Time	2V Step	2.0	<3.0	<3.0	<4.0	ns
TRL		5V Step	3.0	<4.0	<3.6	<4.5	ns
TS	Settling Time to 0.1%	2V Step	12	<18	<18	<22	ns
OS	Overshoot	2V Step	8	<12	<12	<12	%
SR	Slew Rate		1500	>1200	>1200	>1000	V/ μ s
Distortion And Noise Response							
HD2	2nd harmonic distortion	$2V_{PP}$, 20MHz	-44	<-38	<-38	<-34	dBc
HD3	3rd harmonic distortion	$2V_{PP}$, 20MHz	-54	<-46	<-46	<-42	dBc
	Equivalent Input Noise						
VN	Non-Inverting Voltage	>1MHz	3.0	<3.6	<3.6	<4.0	nV/ \sqrt{Hz}
ICN	Inverting Current	>1MHz	11.5	<14	<14	<16	pA/ \sqrt{Hz}
NCN	Non-Inverting Current	>1MHz	2.0	<2.6	<2.6	<3.0	pA/ \sqrt{Hz}
SNF	Total Noise Floor	>1MHz	-157	<-155	<-155	<-154	dBm _{1Hz}
INV	Total Integrated Noise	>1MHz to 100MHz	37	<44	<44	<48	μ V
Static, DC Performance							
VIO	Input Offset Voltage(Note 3)		2	<9	<5	<10	mV

Electrical Characteristics (Continued)(A_V = +6, V_{CC} = ±5V, R_L = 100Ω, R_f = 500Ω; Unless Specified)

Symbol	Parameter	Conditions	Typ	Max/Min (Note 2)			Units
Static, DC Performance							
DVIO	Average Temperature Coefficient		20	<50	-	<50	μV/°C
IBN	Input Bias Current (Note 3)	Non Inverting	5	<25	<13	<13	μA
DIBN	Average Temperature Coefficient		30	<150	-	<50	nA/°C
IBI	Input Bias Current (Note 3)	Inverting	3	<18	<10	<15	μA
DIBI	Average Temperature Coefficient		20	<100	-	<50	nA/°C
PSRR	Power Supply Rejection Ratio		55	>47	>47	>45	dB
CMRR	Common Mode Rejection Ratio		50	>45	>45	>43	dB
ICC	Supply Current, All Channels	No Load	20	<27	<26	<24	mA
Miscellaneous Performance							
RIN	Non-Inverting Input Resistance		1300	>300	>600	>600	kΩ
CIN	Non-Inverting Input Capacitance		1.0	<2.0	<2.0	<2.0	pF
RO	Output Impedance	DC	0.2	<0.6	<0.3	<0.2	Ω
VO	Output Voltage Range	R _L = 100Ω	±2.6	±2.3	±2.5	±2.5	V
CMIR	Common Mode Input Range		±2.2	±1.4	±2.0	±2.0	V
IO	Output Current		60	50	50	50	mA

Note 1: "Absolute Maximum Ratings" are those values beyond which the safety of the device cannot be guaranteed. They are not meant to imply that the devices should be operated at these limits. The table of "Electrical Characteristics" specifies conditions of device operation.

Note 2: Max/min ratings are based on product characterization and simulation. Individual parameters are tested as noted. Outgoing quality levels are determined from tested parameters.

Note 3: AJ-level: spec. is 100% tested at +25°C.

Typical Performance Characteristics ($T_A = 25^\circ$, $A_V = +6$, $V_{CC} = \pm 5V$, $R_L = 100\Omega$, $R_f = 500\Omega$; Unless Specified).

Non-Inverting Frequency Response

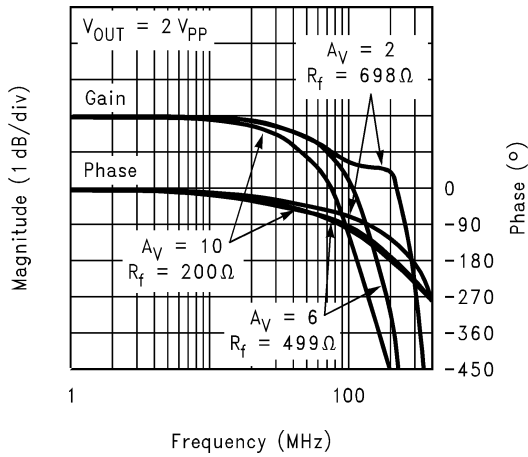

DS012751-1

Inverting Frequency Response

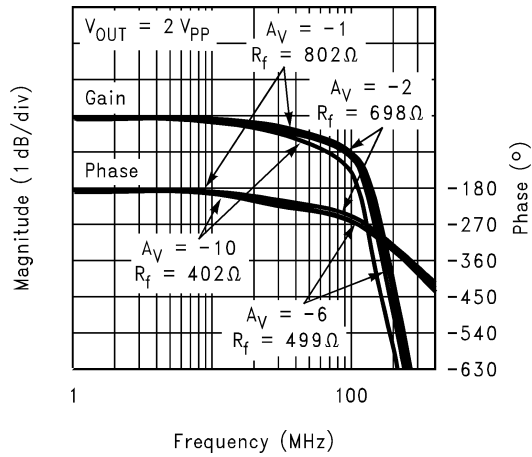

DS012751-2

Frequency Response for Various R_L S

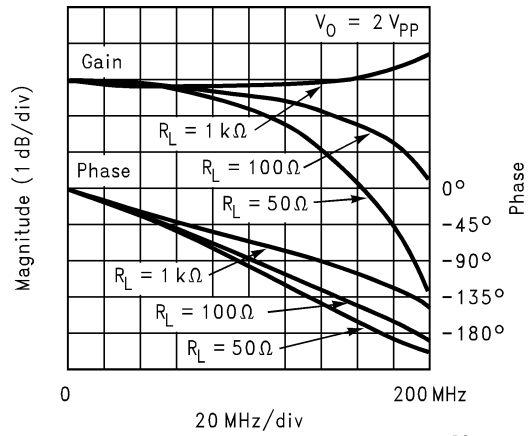

DS012751-3

Small Signal Pulse Response

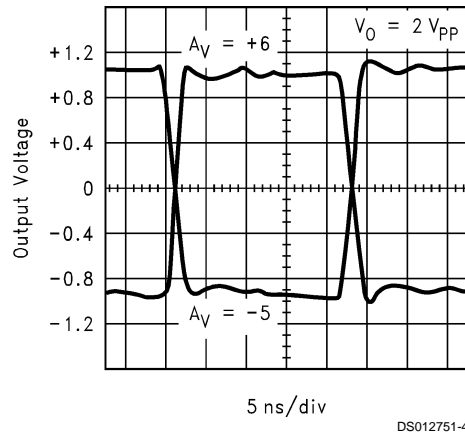

DS012751-4

Short-Term Settling Time

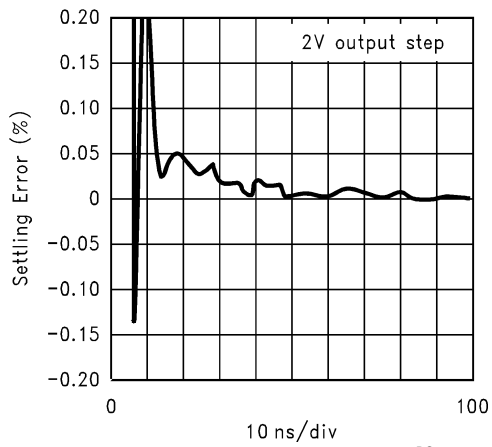

DS012751-5

Long-Term Settling Time

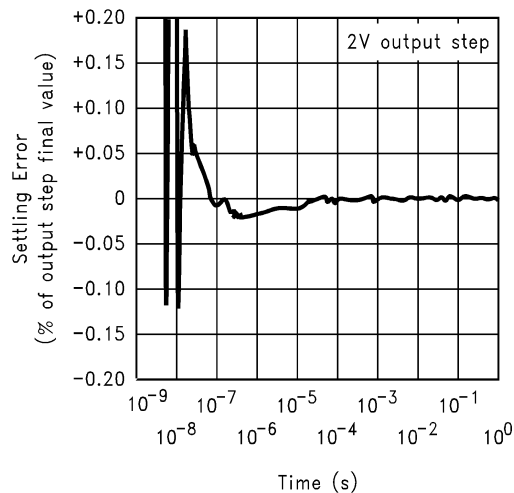

DS012751-6

Typical Performance Characteristics (TA = 25°, AV = +6, VCC = ±5V, RL = 100Ω, Rf = 500Ω; Unless Specified). (Continued)

2nd and 3rd Harmonic Distortion

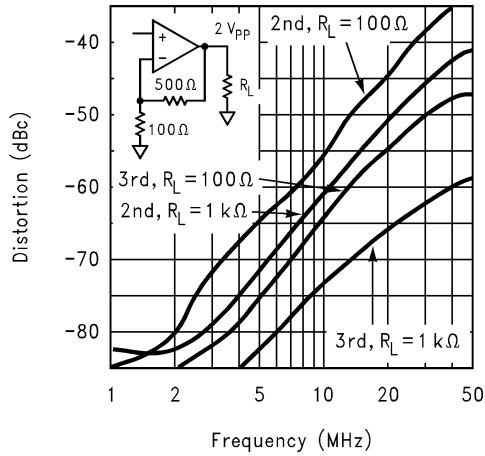

DS012751-7

2-Tone, 3rd Order, Spurious Levels

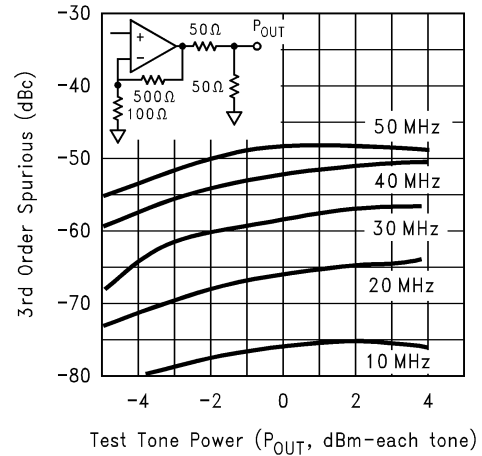

DS012751-8

Settling Time vs. Capacitive Load

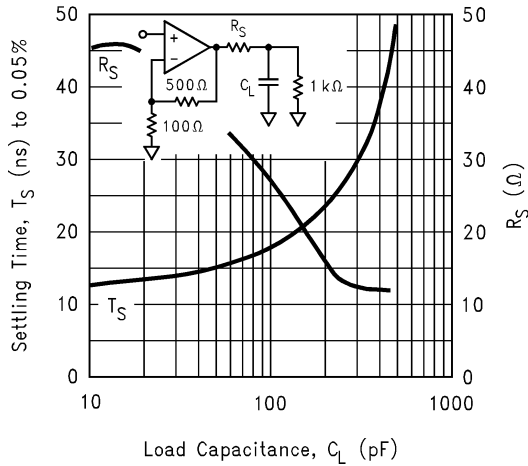

DS012751-9

All-Hostile Crosstalk Isolation

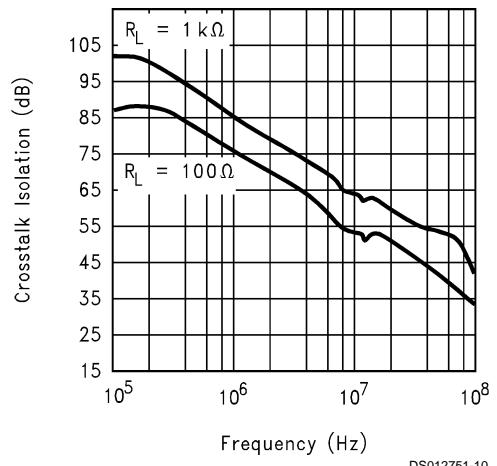

DS012751-10

Most Susceptible Channel-Channel Pulse Coupling

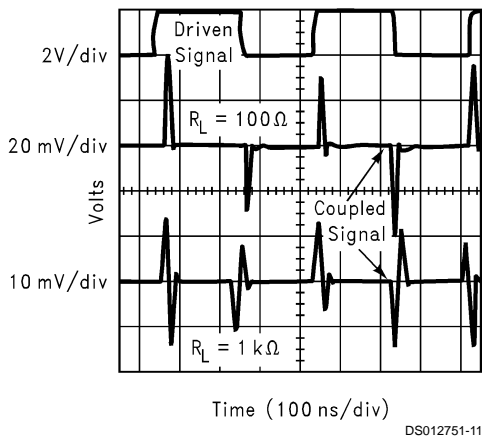

DS012751-11

Differential Gain and Phase (4.43 MHz, AV = +2)

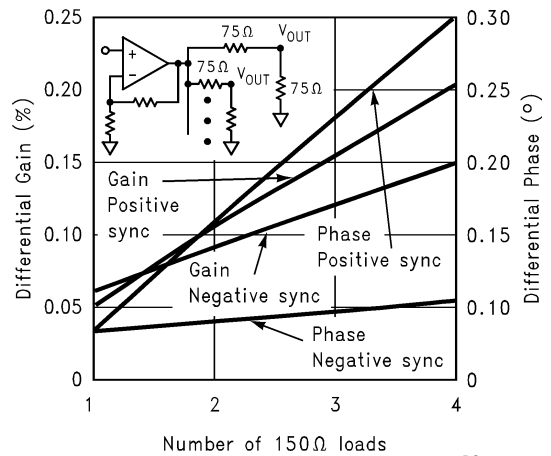

DS012751-12

Typical Performance Characteristics (TA = 25°, AV = +6, VCC = ±5V, RL = 100Ω, Rf = 500Ω; Unless Specified). (Continued)

Equivalent Input Noise

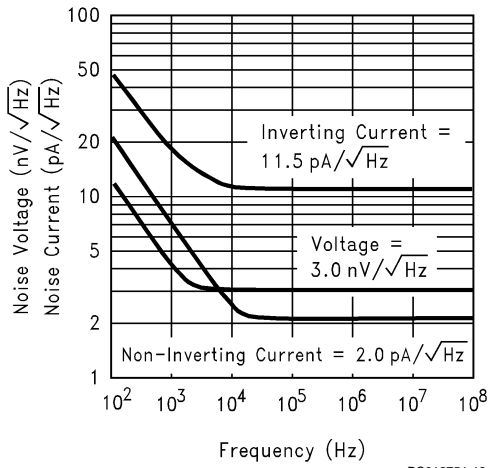

Open-Loop Transimpedance Gain, Z(s)

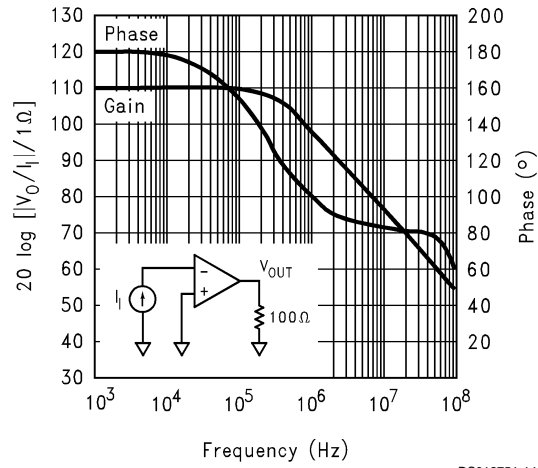

PSRR, CMRR, and Closed Loop R_O

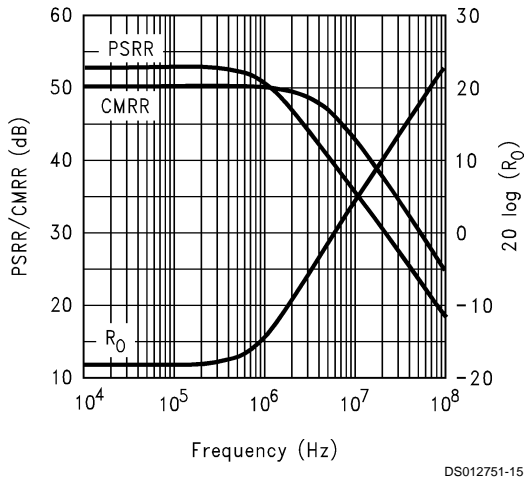

Application Division

Feedback Resistor

The CLC415 achieves its exceptional AC performance while requiring very low quiescent power by using the current feedback topology and an internal slew rate enhancement circuit. The loop gain and frequency response for a current feedback op amp is predominantly set by the feedback resistor value. The CLC415 is optimized for a gain of +6 to use a 500Ω feedback resistor (**use a 900Ω R_f for maximally flat response at a gain of +2**). Using lower values can lead to excessive ringing in the pulse response while higher value will limit the bandwidth.

Application Note OA-13 provides a more detailed discussion of choosing a feedback resistor. The equations found in this application note are to be considered a starting point for the determination of R_f at any gain. The value of input impedance for the CLC415 is approximately 60Ω. These equations do not account for parasitic capacitance at the inverting input nor across R_f. The plot found below entitled "Recommended R_f vs. Gain" offers values of R_f which will optimize the frequency response of the CLC415 over its ±1 to ±10 gain range. Unlike voltage feedback, current feedback op amps require a non-zero R_f for unity gain followers.

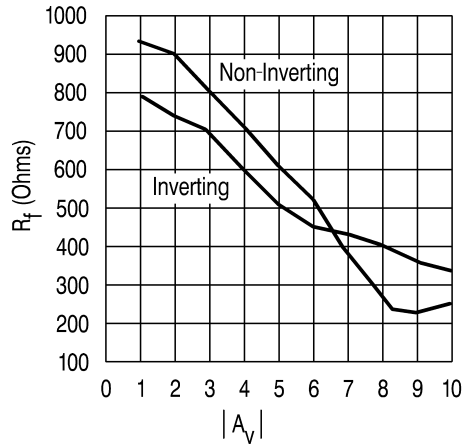

DS012751-19

FIGURE 1. Recommended R_f vs. Gain

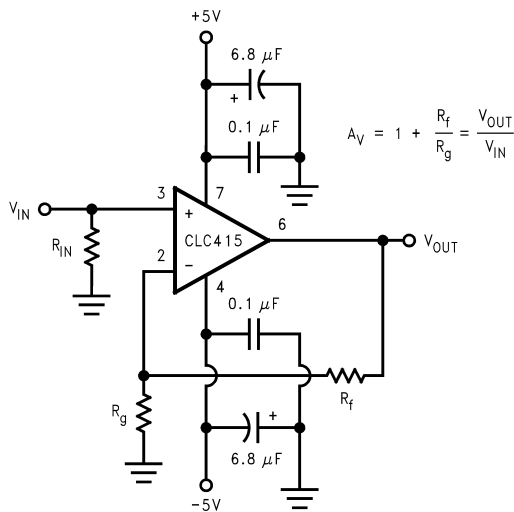

DS012751-16

FIGURE 2. Recommended Non-Inverting Gain Circuit

Non-Inverting Source Impedance

For best operation, the DC source impedance looking out of the non-inverting input should be less than 3kΩ but greater than 20Ω. Parasitic self oscillations may occur in the input transistors if the DC source impedance is out of this range. This impedance also acts as the gain for the non-inverting input bias and noise currents and therefore can become troublesome for high values of DC source impedance. The inverting configuration of Figure 3 shows a 25Ω resistor to ground on the non-inverting input which insures stability but does not provide bias current cancellation. The input bias currents are unrelated for a current feedback amplifier which eliminates the need for source impedance matching to achieve bias current cancellation.

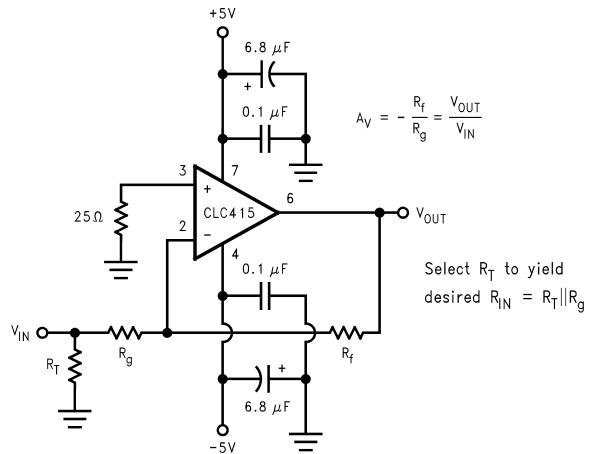

DS012751-17

FIGURE 3. Recommended Inverting Gain Circuit

DC Accuracy and Noise

Please refer to the application information section of the CLC406 for a discussion of output offset voltage and spot noise calculation.

Crosstalk

In any multi-channel integrated circuit there is an undesirable tendency for the signal in one channel to couple with and reproduce itself in the output of another channel. This effect is referred to as crosstalk. Crosstalk is expressed as channel separation or channel isolation which indicates the magnitude of this undesirable effect. This effect is measured by driving one or more channels and observing the output of the other undriven channel(s). The CLC415 plot page offers two different graphs detailing the effect of crosstalk over frequency. One plot entitled "All-Hostile Crosstalk Isolation" graphs all-hostile, input referred crosstalk. All-hostile crosstalk refers to the condition where three channels are driven simultaneously while observing the output of the undriven fourth channel. Input-referred implies that crosstalk is directly affected by gain and therefore a higher gain increases the crosstalk effect by a factor equal to that gain setting. The plot entitled "Most Susceptible Channel-to-Channel Pulse Coupling" describes the effect of crosstalk when one channel is driven with a 2V_{PP} pulse while the output of the most effected channel is observed.

Application Division (Continued)

Unused Amplifiers

It is recommended that any unused amplifiers in the quad package be connected as unity gain followers ($R_f=500\Omega$) with the non-inverting input tied to ground through a 50Ω resistor.

Slew Rate and Harmonic Distortion

Please see the application information for the CLC406.

Differential Gain and Phase

Differential gain and phase performance specifications are common to composite video distribution applications. These specifications refer to the change in small signal gain and phase of the color subcarrier frequency (4.43MHz for PAL composite video) as the amplifier output is swept over a range of DC voltages. Application Note OA-08 provides an additional discussion of differential gain and phase measurements.

Printed Circuit Layout

As with any high speed component, a careful attention to the board layout is necessary for optimum performance. Of par-

ticular importance is the careful control of parasitic capacitances on the output pin. As the output impedance plot shows, the closed loop output for the CLC415 eventually becomes inductive as the loop gain rolls off with increasing frequency. Direct capacitive loading on the output pin can quickly lead to peaking in the frequency response, overshoot in the pulse response, ringing or even sustained oscillations. The "Settling Time vs. Capacitive Load" plot should be used as a starting point for the selection of a series output resistor when a capacitive load must be driven. A quad amplifier will require careful attention to signal routing in order to minimize the effects of crosstalk. Signal coupling through the power supplies can be reduced with bypass capacitors placed close to the device supply pins.

Evaluation Board

Evaluation PC boards (part number CLC730024 for through-hole and 730031 for SOIC) for the CLC415 are available.

Physical Dimensions inches (millimeters) unless otherwise noted

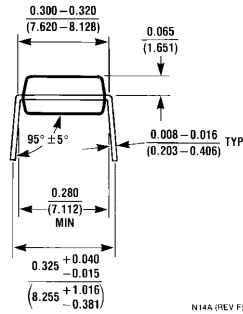
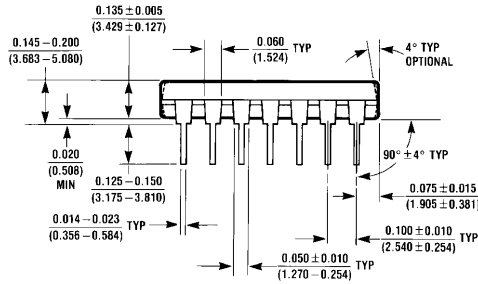
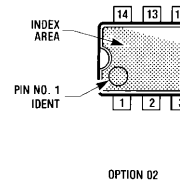
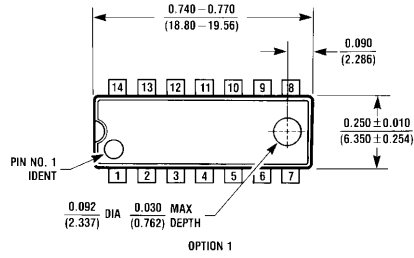

N14A (REV F)

**14-Pin MDIP
NS Package Number N14A**

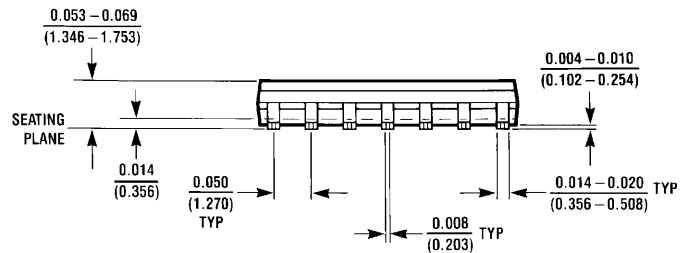
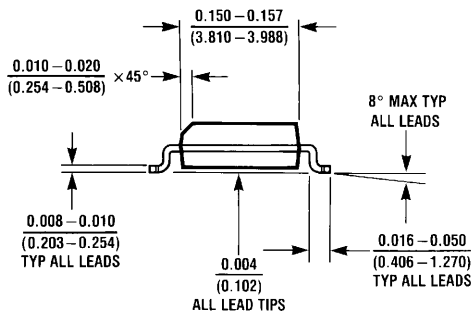
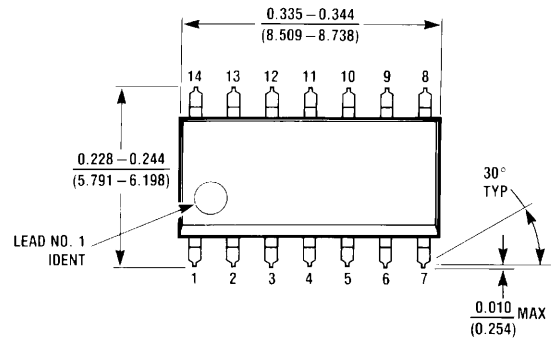

M14A (REV H)

**14-Pin SOIC
NS Package Number M14A**

Notes

LIFE SUPPORT POLICY

NATIONAL'S PRODUCTS ARE NOT AUTHORIZED FOR USE AS CRITICAL COMPONENTS IN LIFE SUPPORT DEVICES OR SYSTEMS WITHOUT THE EXPRESS WRITTEN APPROVAL OF THE PRESIDENT AND GENERAL COUNSEL OF NATIONAL SEMICONDUCTOR CORPORATION. As used herein:

1. Life support devices or systems are devices or systems which, (a) are intended for surgical implant into the body, or (b) support or sustain life, and whose failure to perform when properly used in accordance with instructions for use provided in the labeling, can be reasonably expected to result in a significant injury to the user.
2. A critical component is any component of a life support device or system whose failure to perform can be reasonably expected to cause the failure of the life support device or system, or to affect its safety or effectiveness.



National Semiconductor Corporation
Americas
Email: support@nsc.com

www.national.com

National Semiconductor Europe

Fax: +49 (0) 180-530 85 86
Email: europe.support@nsc.com
Deutsch Tel: +49 (0) 69 9508 6208
English Tel: +44 (0) 870 24 0 2171
Français Tel: +33 (0) 1 41 91 8790

National Semiconductor Asia Pacific Customer Response Group

Tel: 65-2544466
Fax: 65-2504466
Email: ap.support@nsc.com

National Semiconductor Japan Ltd.

Tel: 81-3-5639-7560
Fax: 81-3-5639-7507

IMPORTANT NOTICE

Texas Instruments Incorporated and its subsidiaries (TI) reserve the right to make corrections, modifications, enhancements, improvements, and other changes to its products and services at any time and to discontinue any product or service without notice. Customers should obtain the latest relevant information before placing orders and should verify that such information is current and complete. All products are sold subject to TI's terms and conditions of sale supplied at the time of order acknowledgment.

TI warrants performance of its hardware products to the specifications applicable at the time of sale in accordance with TI's standard warranty. Testing and other quality control techniques are used to the extent TI deems necessary to support this warranty. Except where mandated by government requirements, testing of all parameters of each product is not necessarily performed.

TI assumes no liability for applications assistance or customer product design. Customers are responsible for their products and applications using TI components. To minimize the risks associated with customer products and applications, customers should provide adequate design and operating safeguards.

TI does not warrant or represent that any license, either express or implied, is granted under any TI patent right, copyright, mask work right, or other TI intellectual property right relating to any combination, machine, or process in which TI products or services are used. Information published by TI regarding third-party products or services does not constitute a license from TI to use such products or services or a warranty or endorsement thereof. Use of such information may require a license from a third party under the patents or other intellectual property of the third party, or a license from TI under the patents or other intellectual property of TI.

Reproduction of TI information in TI data books or data sheets is permissible only if reproduction is without alteration and is accompanied by all associated warranties, conditions, limitations, and notices. Reproduction of this information with alteration is an unfair and deceptive business practice. TI is not responsible or liable for such altered documentation. Information of third parties may be subject to additional restrictions.

Resale of TI products or services with statements different from or beyond the parameters stated by TI for that product or service voids all express and any implied warranties for the associated TI product or service and is an unfair and deceptive business practice. TI is not responsible or liable for any such statements.

TI products are not authorized for use in safety-critical applications (such as life support) where a failure of the TI product would reasonably be expected to cause severe personal injury or death, unless officers of the parties have executed an agreement specifically governing such use. Buyers represent that they have all necessary expertise in the safety and regulatory ramifications of their applications, and acknowledge and agree that they are solely responsible for all legal, regulatory and safety-related requirements concerning their products and any use of TI products in such safety-critical applications, notwithstanding any applications-related information or support that may be provided by TI. Further, Buyers must fully indemnify TI and its representatives against any damages arising out of the use of TI products in such safety-critical applications.

TI products are neither designed nor intended for use in military/aerospace applications or environments unless the TI products are specifically designated by TI as military-grade or "enhanced plastic." Only products designated by TI as military-grade meet military specifications. Buyers acknowledge and agree that any such use of TI products which TI has not designated as military-grade is solely at the Buyer's risk, and that they are solely responsible for compliance with all legal and regulatory requirements in connection with such use.

TI products are neither designed nor intended for use in automotive applications or environments unless the specific TI products are designated by TI as compliant with ISO/TS 16949 requirements. Buyers acknowledge and agree that, if they use any non-designated products in automotive applications, TI will not be responsible for any failure to meet such requirements.

Following are URLs where you can obtain information on other Texas Instruments products and application solutions:

Products

Audio	www.ti.com/audio
Amplifiers	amplifier.ti.com
Data Converters	dataconverter.ti.com
DLP® Products	www.dlp.com
DSP	dsp.ti.com
Clocks and Timers	www.ti.com/clocks
Interface	interface.ti.com
Logic	logic.ti.com
Power Mgmt	power.ti.com
Microcontrollers	microcontroller.ti.com
RFID	www.ti-rfid.com
OMAP Mobile Processors	www.ti.com/omap
Wireless Connectivity	www.ti.com/wirelessconnectivity

Applications

Communications and Telecom	www.ti.com/communications
Computers and Peripherals	www.ti.com/computers
Consumer Electronics	www.ti.com/consumer-apps
Energy and Lighting	www.ti.com/energy
Industrial	www.ti.com/industrial
Medical	www.ti.com/medical
Security	www.ti.com/security
Space, Avionics and Defense	www.ti.com/space-avionics-defense
Transportation and Automotive	www.ti.com/automotive
Video and Imaging	www.ti.com/video

TI E2E Community Home Page

e2e.ti.com

Mailing Address: Texas Instruments, Post Office Box 655303, Dallas, Texas 75265
Copyright © 2011, Texas Instruments Incorporated