

CLC420

CLC420 High Speed, Voltage Feedback Op Amp



Literature Number: SNOS857F

CLC420

High Speed, Voltage Feedback Op Amp

General Description

The CLC420 is an operational amplifier designed for applications requiring matched inputs, integration or transimpedance amplification. Utilizing voltage feedback architecture, the CLC420 offers a 300MHz bandwidth, a 1100V/ μ s slew rate and a 4mA supply current (power consumption of 40mW, \pm 5V supplies).

Applications such as differential amplifiers will benefit from 70dB common mode rejection ratio and an input offset current of 0.2 μ A. With its unity-gain stability, 2pA/ \sqrt Hz current noise and 3 μ A of input bias current, the CLC420 is designed to meet the needs of filter applications and log amplifiers. The low input offset current and current noise, combined with a settling time of 18ns to 0.01% make the CLC420 ideal for D/A converters, pin diode receivers and photo multipliers amplifiers. All applications will find 70dB power supply rejection ratio attractive.

Features

- 300MHz small signal bandwidth
- 1100V/ μ s slew rate
- Unity-gain stability
- Low distortion, -60dBc at 20MHz
- 0.01% settling in 18ns
- 0.2 μ A input offset current
- 2pA/ \sqrt Hz current noise

Applications

- Active filters/integrators
- Differential amplifiers
- Pin diode receivers
- Log amplifiers
- D/A converters
- Photo multiplier amplifiers

Non-Inverting Frequency Response

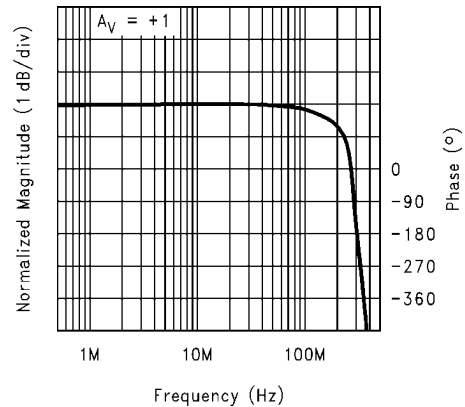

1275219

Connection Diagram

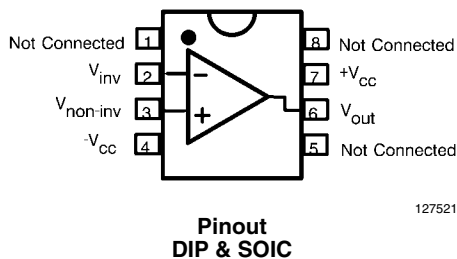

1275218

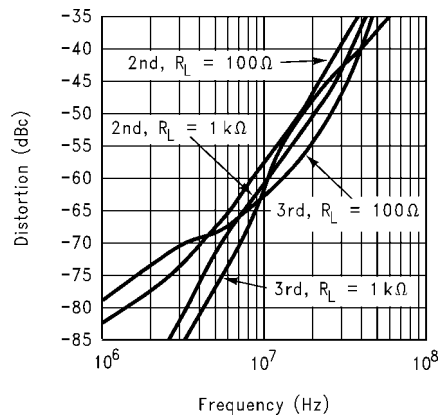

1275220

2nd and 3rd Harmonic Distortion

Ordering Information

Package	Temperature Range Industrial	Part Number	Package Marking	NSC Drawing
8-pin plastic DIP	-40°C to +85°C	CLC420AJP	CLC420AJP	N08E
8-pin plastic SOIC	-40°C to +85°C	CLC420AJE	CLC420AJE	M08A
		CLC420AJE-TR13	CLC420AJE	

Absolute Maximum Ratings (Note 1)

If Military/Aerospace specified devices are required, please contact the National Semiconductor Sales Office/Distributors for availability and specifications.

Supply Voltage (V_{CC}) $\pm 7V$

I_{OUT} 70mA

(is short circuit protected to ground, but maximum reliability will be maintained if I_{OUT} does not exceed 70mA, except A8D, B8D which should not exceed 35mA over the military temperature range)..

Common Mode Input Voltage $\pm V_{CC}$

Differential Input Voltage 10V

Junction Temperature $+150^{\circ}C$

Operating Temperature Range $-40^{\circ}C$ to $+85^{\circ}C$

Storage Temperature Range $-65^{\circ}C$ to $+150^{\circ}C$

Lead Solder Duration ($+300^{\circ}C$) 10 sec

Operating Ratings

Thermal Resistance

Package (θ_{JC}) (θ_{JA})

MDIP $65^{\circ}C/W$ $120^{\circ}C/W$

SOIC $60^{\circ}C/W$ $140^{\circ}C/W$

Electrical Characteristics

$A_V = +1$, $V_{CC} = \pm 5V$, $R_L = 100\Omega$, $R_f = 0\Omega$; unless specified

Symbol	Parameter	Conditions	Typ	Max/Min (Note 2)			Units
Ambient Temperature		CLC420AJ	$+25^{\circ}C$	$-40^{\circ}C$	$+25^{\circ}C$	$+85^{\circ}C$	
Frequency Domain Response							
SSBW	-3dB Bandwidth	$V_{OUT} < 0.4V_{PP}$	300	>200	>200	>130	MHz
LSBW		$V_{OUT} < 5V_{PP}$	40	>20	>25	>20	MHz
SSBWI	$A_V = -1$, $R_f = 500\Omega$	$V_{OUT} < 0.4V_{PP}$	100	>65	>65	>45	MHz
LSBWI	$A_V = -1$, $R_f = 500\Omega$	$V_{OUT} < 5V_{PP}$	60	>30	>35	>30	MHz
	Gain Flatness	$V_{OUT} < 0.4V_{PP}$					
GFPL	Peaking	0.1MHz to 100MHz	0	<1	<0.6	<0.6	dB
GFPH	Peaking	>100MHz	0	<5	<3	<3	dB
GFR	Rolloff	0.1MHz to 100MHz	0.2	<1	<1	<2	dB
GFRI	Rolloff, $A_V = -1$, $R_f = 500\Omega$	0.1MHz to 30MHz	0.2	<1.4	<1.4	<1.6	dB
LPD	Linear Phase Deviation	0.1MHz to 100MHz	0.9	<1.8	<1.8	<2.5	deg
Time Domain Response							
TRS	Rise and Fall Time	0.4V Step	1.2	<2	<2	<3	ns
TRL		5V Step	1.4	<25	<20	<20	ns
TRSI	Rise and Fall Time, $A_V = -1$, $R_f = 500\Omega$	0.4V Step	3.5	<5.5	<5.5	<7.8	ns
TRLI		5V Step	6	<10	<9.5	<10	ns
TSS	Settling Time to $\pm 0.1\%$	2V Step	12	<18	<18	<18	ns
TSP	$\pm 0.01\%$	2V Step	18	<25	<25	<25	ns
OS	Overshoot	0.4V Step	8	<35	<25	<25	%
SR	Slew Rate, $A_V = +2$	5V Step	1100	>600	>750	>600	V/ μ s
SRI	Slew Rate, $A_V = -1$, $R_f = 500\Omega$	5V Step	750	>430	>500	>430	V/ μ s
Distortion And Noise Response							
HD2	2nd Harmonic Distortion	$2V_{PP}$, 20MHz	-50	<-40	<-40	<-40	dBc
HD3	3rd Harmonic Distortion	$2V_{PP}$, 20MHz	-53	<-45	<-45	<-40	dBc
HD2	2nd Harmonic Distortion	$A_V = -1$ $2V_{PP}$, 20MHz, $R_f = 500\Omega$	-51	<-40	<-40	<-40	dBc
HD3	3rd harmonic distortion	$A_V = -1$, $R_f = 500\Omega$ $2V_{PP}$, 20MHz, $R_f = 500\Omega$	-51	<-40	<-40	<-35	dBc
	Input Referred Noise						
VN	Voltage	1MHz to 200MHz	4.2	<5.3	<5.3	<6	nV/ \sqrt{Hz}
ICN	Current	1MHz to 200MHz	2	<2.9	<2.6	<2.3	pA/ \sqrt{Hz}

Symbol	Parameter	Conditions	Typ	Max/Min (Note 2)			Units
Static DC Performance							
VIO	Input Offset Voltage (Note 3)		1	<3.2	<2	<3.5	mV
DVIO	Average Temperature Coefficient		8	<15	-	<15	$\mu\text{V}/^\circ\text{C}$
IB	Input Bias Current (Note 3)		3	<20	<10	<10	μA
DIB	Average Temperature Coefficient		45	<120	-	<60	$\text{nA}/^\circ\text{C}$
IIO	Input Offset Current (Note 3)		0.2	<2.6	<1	<2	μA
DIIO	Average Temperature Coefficient		2	<20	-	<10	$\text{nA}/^\circ\text{C}$
AOL	Open Loop Gain (Note 3)		65	>52	>56	>56	μA
PSRR	Power Supply Rejection Ratio		70	>55	>60	>60	dB
CMRR	Common Mode Rejection Ratio		80	>60	>65	>65	dB
ICC	Supply Current (Note 3)	No Load, Quiescent	4	<5	<5	<5	mA
Miscellaneous Performance							
RIND	Differential Mode Input	Resistance	2	>0.5	>1	>1	$\text{M}\Omega$
CIND		Capacitance	1	<2	<2	<2	pF
RINC	Common Mode Input	Resistance	1	>0.25	>0.5	>0.5	$\text{M}\Omega$
CINC		Capacitance	1	<2	<2	<2	pF
RO	Output Impedance	At DC	0.02	<0.3	<0.2	<0.2	Ω
VO	Output Voltage Range	No Load	± 3.6	± 2.8	± 3	± 3	V
VOL	Output Voltage Range	$R_L = 100\Omega$	± 2.9	± 2.5	± 2.5	± 2.5	V
CMIR	Common Mode Input Range	For Rated Performance	± 3.2	± 2.5	± 2.8	± 2.8	V
IO	Output Current		± 60	± 30	± 50	± 50	mA

Note 1: "Absolute Maximum Ratings" are those values beyond which the safety of the device cannot be guaranteed. They are not meant to imply that the devices should be operated at these limits. The table of "Electrical Characteristics" specifies conditions of device operation.

Note 2: Max/min ratings are based on product characterization and simulation. Individual parameters are tested as noted. Outgoing quality levels are determined from tested parameters.

Note 3: AJ-level: spec. is 100% tested at $+25^\circ\text{C}$.

Typical Performance Characteristics

Non-Inverting Frequency Response

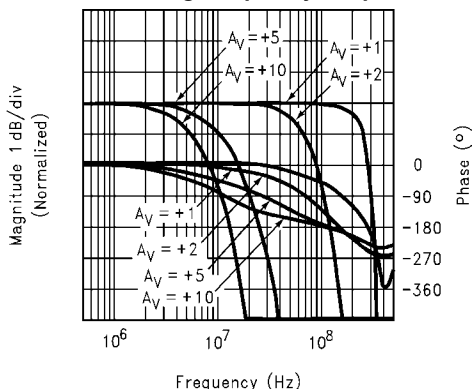

1275201

Inverting Frequency Response

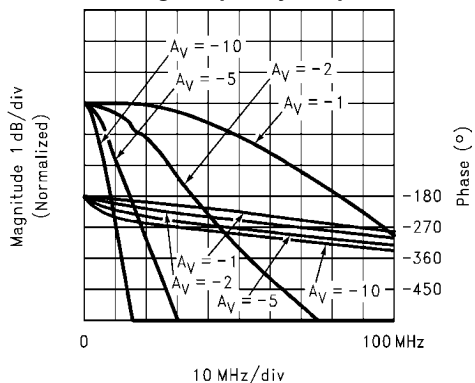

1275202

Frequency Response for Various RL S

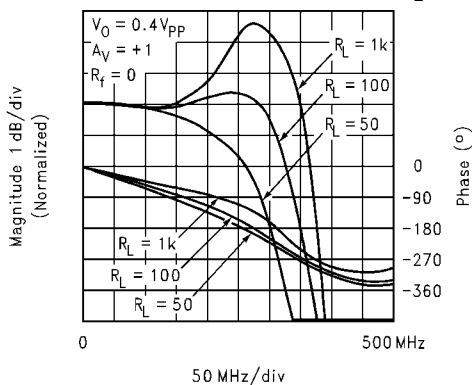

1275203

Open Loop Gain and Phase

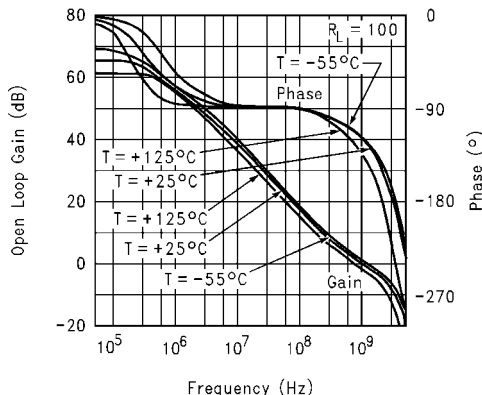

1275204

Bandwidth vs. Gain, Transimpedance Configuration

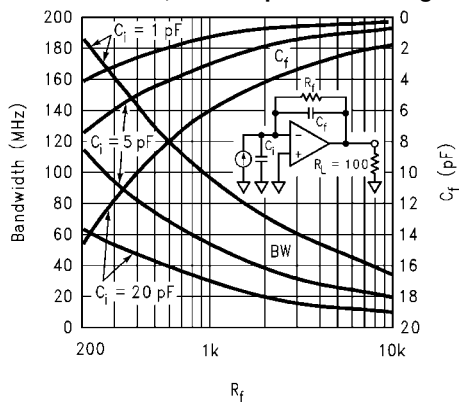

1275205

2nd and 3rd Harmonic Distortion

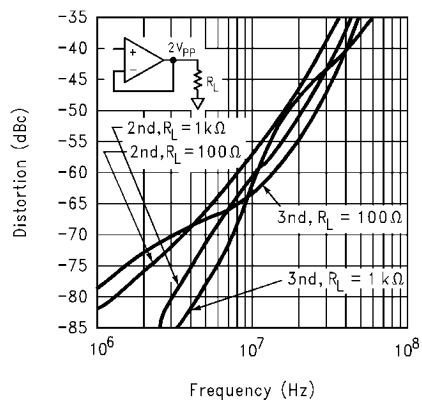

1275206

2-Tone, 3rd Order Intermodulation Intercept

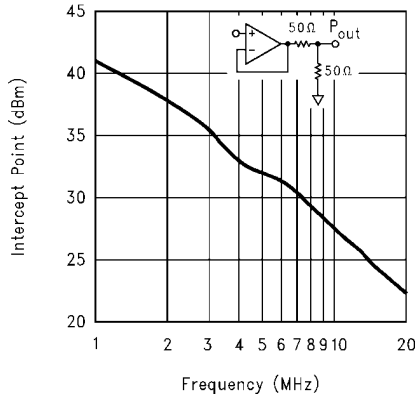

1275207

Equivalent Input Noise

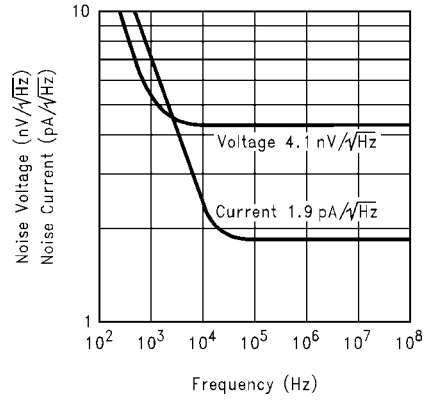

1275208

PSRR, CMRR, and Closed Loop R_O

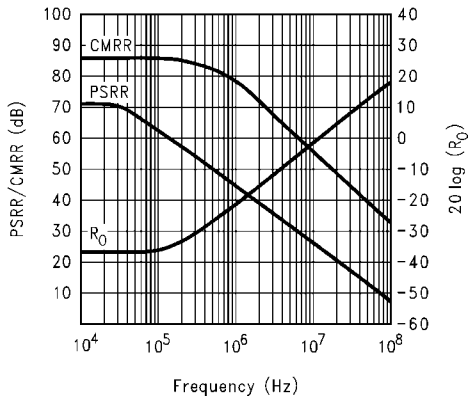

1275209

Pulse Response

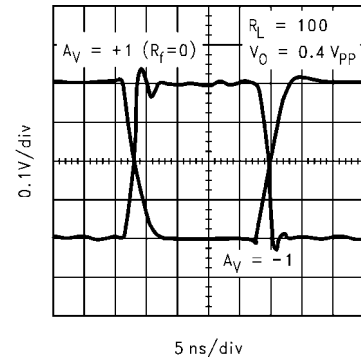

1275210

Settling Time

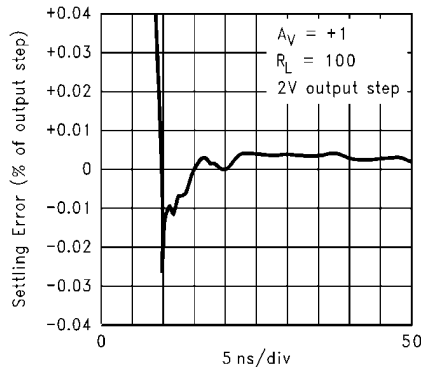

1275211

Long-Term Settling Time

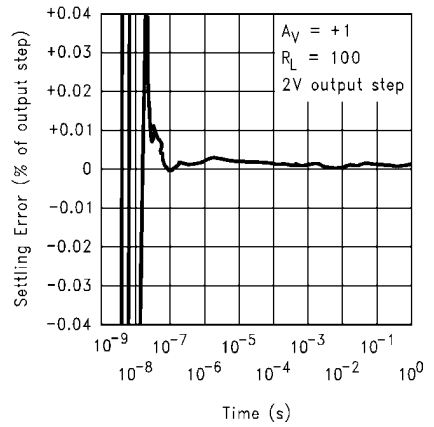

1275212

Settling Time vs. Capacitive Load

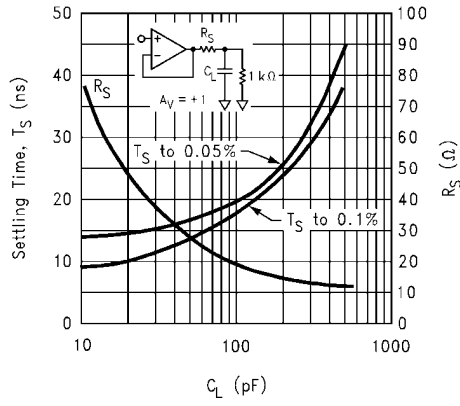

1275213

Settling Time vs. Gain

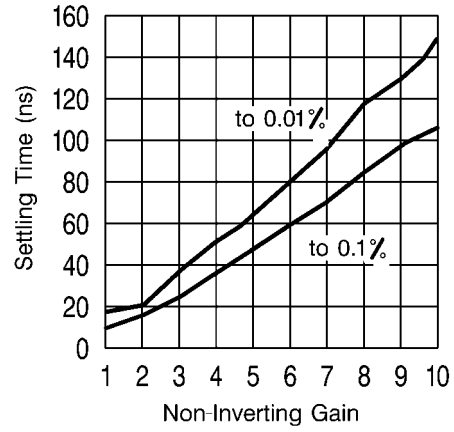

1275214

I_B and I_{OS} vs. Common-Mode Voltage

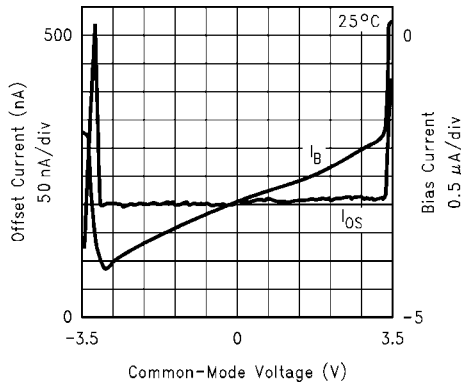

1275215

Application Division

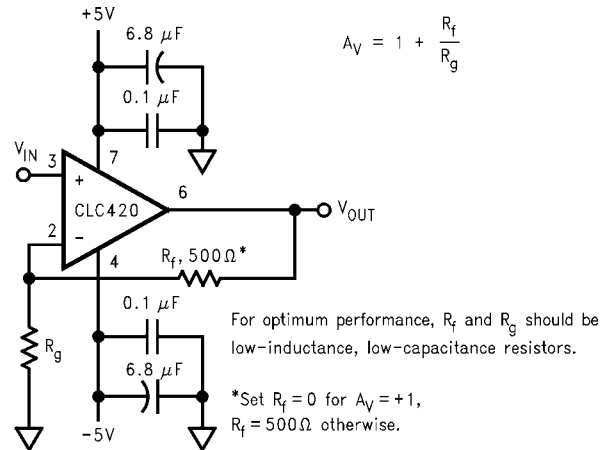

1275216

FIGURE 1. Recommended Non-Inverting Gain Circuit

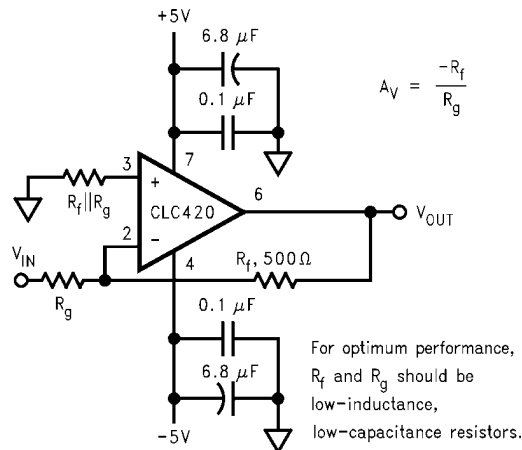

1275217

FIGURE 2. Recommended Inverting Gain Circuit

Description

The CLC420 is a high speed, slew boosted, voltage feedback amplifier with unity-gain stability. These features along with matched inputs, low input bias and noise currents, and excellent CMRR render the CLC420 very attractive for active filters, differential amplifiers, log amplifiers, and transimpedance amplifiers.

DC accuracy

Unlike current feedback amplifiers, voltage-feedback amplifiers have matched inputs. This means that the non inverting and inverting input bias current are well matched and track over temperature, etc. As a result, by matching the resistance looking out of the two inputs, these errors can be reduced to a small offset current term.

Gain bandwidth product

Since the CLC420 is a voltage feedback op amp, closed loop bandwidth is approximately equal to the gain bandwidth product (typically 100MHz) divided by the noise gain of the circuit (for noise gains greater than 5). At lower noise gains, higher

order amplifier poles contribute to higher closed loop bandwidth. At low gains use the frequency response performance plots given in the data sheet.

Another point to remember is that the closed loop bandwidth is determined by the noise gain, not the signal gain of the circuit. Noise gain is the reciprocal of the attenuation in the feedback network enclosing the op amp. For example, a CLC420 setup as a non-inverting amplifier with a closed loop gain of +1 (a noise gain of 1) has a 300MHz bandwidth. When used as an inverting amplifier with a gain of -1 (a noise gain of 2), the bandwidth is less, typically only 100MHz.

Full-power bandwidth, and slew-rate

The CLC420 combines exceptional full power bandwidths (40MHz, $V_0 = 5V_{pp}$, $A_V = +1$) and slew rates (1100V/μs, $A_V = +1$) with low (40mW) power consumption. These attractive results are achieved by using slew boosting circuitry to keep the slew rates high while consuming very little power.

In non slew boosted amplifiers, full power bandwidth can be easily determined from slew rate measurements, but in slew

boosting amplifiers, such as the CLC420, you can't. For this reason we provide data for both.

Slew rate is also different for inverting and non-inverting configurations. This occurs because common-mode signal voltages are present in non-inverting circuits but absent in inverting circuits. Once again data is provided for both.

Transimpedance amplifier circuits

Low inverting, input current noise ($2\text{pA}/\sqrt{\text{Hz}}$) makes the CLC420 ideal for high sensitivity transimpedance amplifier circuits for applications such as pin diode optical receivers, and detectors in receiver IFs. However, feedback resistors $4\text{k}\Omega$ or greater are required if feedback resistor noise current is going to be less than the input current noise contribution of the op amp.

With feedback resistors this large, shunt capacitance on the inverting input of the op amp (from the pin diode, etc.) will unacceptably degrade phase margin causing frequency response peaking or oscillations a small valued capacitor shunting the feedback resistor solves this problem (Note: This approach does not work for a current-feedback op amp configured for transimpedance applications). To determine the value of this capacitor, refer to the "Transimpedance BW vs. R_f and C_i " plot.

For example, let's assume an optical transimpedance receiver is being developed. Total capacitance from the inverting input to ground, including the photodiode and strays is 5pF .

A $5\text{k}\Omega$ feedback resistor value has been determined to provide best dynamic range based on the response of the photodiode and the range of incident optical powers, etc. From the "Transimpedance BW vs. R_f and C_i " plot, using $C_i = 5\text{pF}$ it is determined from the two curves labeled $C_i = 5\text{pF}$, that $C_i = 1.5\text{pF}$ provides optimal compensation (no more than 0.5dB frequency response peaking) and a -3dB bandwidth of approximately 27MHz .

Printed circuit layout

As with any high frequency device, a good PCB layout will enhance performance. Ground plane construction and good power supply bypassing close to the package are critical to achieving full performance. The amplifier is sensitive to stray capacitance to ground at the output and inverting input: Node connections should be small with minimal coupling to the ground plane.

Parasitic or load capacitance directly on the output (pin 6) will introduce additional phase shift in the loop degrading the loop phase margin and leading to frequency response peaking. A small series resistor before this capacitance, if present, effectively decouples this effect. The graphs on the preceding page, "Settling Time vs. C_L ", illustrates the required resistor value and resulting performance vs. capacitance.

Evaluation PC boards (part no. 730013 for through-hole and CLC730027 for SOIC) are available for the CLC420.

Notes

Notes

For more National Semiconductor product information and proven design tools, visit the following Web sites at:

Products		Design Support	
Amplifiers	www.national.com/amplifiers	WEBENCH® Tools	www.national.com/webench
Audio	www.national.com/audio	App Notes	www.national.com/appnotes
Clock and Timing	www.national.com/timing	Reference Designs	www.national.com/refdesigns
Data Converters	www.national.com/adc	Samples	www.national.com/samples
Interface	www.national.com/interface	Eval Boards	www.national.com/evalboards
LVDS	www.national.com/lvds	Packaging	www.national.com/packaging
Power Management	www.national.com/power	Green Compliance	www.national.com/quality/green
Switching Regulators	www.national.com/switchers	Distributors	www.national.com/contacts
LDOs	www.national.com/ldo	Quality and Reliability	www.national.com/quality
LED Lighting	www.national.com/led	Feedback/Support	www.national.com/feedback
Voltage Reference	www.national.com/vref	Design Made Easy	www.national.com/easy
PowerWise® Solutions	www.national.com/powerwise	Solutions	www.national.com/solutions
Serial Digital Interface (SDI)	www.national.com/sdi	Mil/Aero	www.national.com/milaero
Temperature Sensors	www.national.com/tempensors	SolarMagic™	www.national.com/solarmagic
Wireless (PLL/VCO)	www.national.com/wireless	PowerWise® Design University	www.national.com/training

THE CONTENTS OF THIS DOCUMENT ARE PROVIDED IN CONNECTION WITH NATIONAL SEMICONDUCTOR CORPORATION ("NATIONAL") PRODUCTS. NATIONAL MAKES NO REPRESENTATIONS OR WARRANTIES WITH RESPECT TO THE ACCURACY OR COMPLETENESS OF THE CONTENTS OF THIS PUBLICATION AND RESERVES THE RIGHT TO MAKE CHANGES TO SPECIFICATIONS AND PRODUCT DESCRIPTIONS AT ANY TIME WITHOUT NOTICE. NO LICENSE, WHETHER EXPRESS, IMPLIED, ARISING BY ESTOPPEL OR OTHERWISE, TO ANY INTELLECTUAL PROPERTY RIGHTS IS GRANTED BY THIS DOCUMENT.

TESTING AND OTHER QUALITY CONTROLS ARE USED TO THE EXTENT NATIONAL DEEMS NECESSARY TO SUPPORT NATIONAL'S PRODUCT WARRANTY. EXCEPT WHERE MANDATED BY GOVERNMENT REQUIREMENTS, TESTING OF ALL PARAMETERS OF EACH PRODUCT IS NOT NECESSARILY PERFORMED. NATIONAL ASSUMES NO LIABILITY FOR APPLICATIONS ASSISTANCE OR BUYER PRODUCT DESIGN. BUYERS ARE RESPONSIBLE FOR THEIR PRODUCTS AND APPLICATIONS USING NATIONAL COMPONENTS. PRIOR TO USING OR DISTRIBUTING ANY PRODUCTS THAT INCLUDE NATIONAL COMPONENTS, BUYERS SHOULD PROVIDE ADEQUATE DESIGN, TESTING AND OPERATING SAFEGUARDS.

EXCEPT AS PROVIDED IN NATIONAL'S TERMS AND CONDITIONS OF SALE FOR SUCH PRODUCTS, NATIONAL ASSUMES NO LIABILITY WHATSOEVER, AND NATIONAL DISCLAIMS ANY EXPRESS OR IMPLIED WARRANTY RELATING TO THE SALE AND/OR USE OF NATIONAL PRODUCTS INCLUDING LIABILITY OR WARRANTIES RELATING TO FITNESS FOR A PARTICULAR PURPOSE, MERCHANTABILITY, OR INFRINGEMENT OF ANY PATENT, COPYRIGHT OR OTHER INTELLECTUAL PROPERTY RIGHT.

LIFE SUPPORT POLICY

NATIONAL'S PRODUCTS ARE NOT AUTHORIZED FOR USE AS CRITICAL COMPONENTS IN LIFE SUPPORT DEVICES OR SYSTEMS WITHOUT THE EXPRESS PRIOR WRITTEN APPROVAL OF THE CHIEF EXECUTIVE OFFICER AND GENERAL COUNSEL OF NATIONAL SEMICONDUCTOR CORPORATION. As used herein:

Life support devices or systems are devices which (a) are intended for surgical implant into the body, or (b) support or sustain life and whose failure to perform when properly used in accordance with instructions for use provided in the labeling can be reasonably expected to result in a significant injury to the user. A critical component is any component in a life support device or system whose failure to perform can be reasonably expected to cause the failure of the life support device or system or to affect its safety or effectiveness.

National Semiconductor and the National Semiconductor logo are registered trademarks of National Semiconductor Corporation. All other brand or product names may be trademarks or registered trademarks of their respective holders.

Copyright© 2009 National Semiconductor Corporation

For the most current product information visit us at www.national.com



**National Semiconductor
Americas Technical
Support Center**
Email: support@nsc.com
Tel: 1-800-272-9959

**National Semiconductor Europe
Technical Support Center**
Email: europe.support@nsc.com

**National Semiconductor Asia
Pacific Technical Support Center**
Email: ap.support@nsc.com

**National Semiconductor Japan
Technical Support Center**
Email: jpn.feedback@nsc.com

IMPORTANT NOTICE

Texas Instruments Incorporated and its subsidiaries (TI) reserve the right to make corrections, modifications, enhancements, improvements, and other changes to its products and services at any time and to discontinue any product or service without notice. Customers should obtain the latest relevant information before placing orders and should verify that such information is current and complete. All products are sold subject to TI's terms and conditions of sale supplied at the time of order acknowledgment.

TI warrants performance of its hardware products to the specifications applicable at the time of sale in accordance with TI's standard warranty. Testing and other quality control techniques are used to the extent TI deems necessary to support this warranty. Except where mandated by government requirements, testing of all parameters of each product is not necessarily performed.

TI assumes no liability for applications assistance or customer product design. Customers are responsible for their products and applications using TI components. To minimize the risks associated with customer products and applications, customers should provide adequate design and operating safeguards.

TI does not warrant or represent that any license, either express or implied, is granted under any TI patent right, copyright, mask work right, or other TI intellectual property right relating to any combination, machine, or process in which TI products or services are used. Information published by TI regarding third-party products or services does not constitute a license from TI to use such products or services or a warranty or endorsement thereof. Use of such information may require a license from a third party under the patents or other intellectual property of the third party, or a license from TI under the patents or other intellectual property of TI.

Reproduction of TI information in TI data books or data sheets is permissible only if reproduction is without alteration and is accompanied by all associated warranties, conditions, limitations, and notices. Reproduction of this information with alteration is an unfair and deceptive business practice. TI is not responsible or liable for such altered documentation. Information of third parties may be subject to additional restrictions.

Resale of TI products or services with statements different from or beyond the parameters stated by TI for that product or service voids all express and any implied warranties for the associated TI product or service and is an unfair and deceptive business practice. TI is not responsible or liable for any such statements.

TI products are not authorized for use in safety-critical applications (such as life support) where a failure of the TI product would reasonably be expected to cause severe personal injury or death, unless officers of the parties have executed an agreement specifically governing such use. Buyers represent that they have all necessary expertise in the safety and regulatory ramifications of their applications, and acknowledge and agree that they are solely responsible for all legal, regulatory and safety-related requirements concerning their products and any use of TI products in such safety-critical applications, notwithstanding any applications-related information or support that may be provided by TI. Further, Buyers must fully indemnify TI and its representatives against any damages arising out of the use of TI products in such safety-critical applications.

TI products are neither designed nor intended for use in military/aerospace applications or environments unless the TI products are specifically designated by TI as military-grade or "enhanced plastic." Only products designated by TI as military-grade meet military specifications. Buyers acknowledge and agree that any such use of TI products which TI has not designated as military-grade is solely at the Buyer's risk, and that they are solely responsible for compliance with all legal and regulatory requirements in connection with such use.

TI products are neither designed nor intended for use in automotive applications or environments unless the specific TI products are designated by TI as compliant with ISO/TS 16949 requirements. Buyers acknowledge and agree that, if they use any non-designated products in automotive applications, TI will not be responsible for any failure to meet such requirements.

Following are URLs where you can obtain information on other Texas Instruments products and application solutions:

Products

Audio	www.ti.com/audio
Amplifiers	amplifier.ti.com
Data Converters	dataconverter.ti.com
DLP® Products	www.dlp.com
DSP	dsp.ti.com
Clocks and Timers	www.ti.com/clocks
Interface	interface.ti.com
Logic	logic.ti.com
Power Mgmt	power.ti.com
Microcontrollers	microcontroller.ti.com
RFID	www.ti-rfid.com
OMAP Mobile Processors	www.ti.com/omap
Wireless Connectivity	www.ti.com/wirelessconnectivity

Applications

Communications and Telecom	www.ti.com/communications
Computers and Peripherals	www.ti.com/computers
Consumer Electronics	www.ti.com/consumer-apps
Energy and Lighting	www.ti.com/energy
Industrial	www.ti.com/industrial
Medical	www.ti.com/medical
Security	www.ti.com/security
Space, Avionics and Defense	www.ti.com/space-avionics-defense
Transportation and Automotive	www.ti.com/automotive
Video and Imaging	www.ti.com/video

TI E2E Community Home Page

e2e.ti.com

Mailing Address: Texas Instruments, Post Office Box 655303, Dallas, Texas 75265
Copyright © 2011, Texas Instruments Incorporated