

CLC505

CLC505 High Speed, Programmable Supply Current, Monolithic Op Amp



Literature Number: SNOS860C

CLC505

High Speed, Programmable Supply Current, Monolithic Op Amp

General Description

The CLC505 is a monolithic, high speed op amp with a unique combination of high performance, low power consumption, and flexibility of application. The supply current is programmable over a 10 to 1 continuous range with a single resistor, R_p . This feature enables the amplifier to be used in a wide variety of high performance applications. Typical performance at any supply current is exceptional:

Parameter	Supply Current (I_{CC})			Units
	9mA	3.4mA	1mA	
-3dB Bandwidth	150	100	50	MHz
Settling Time	12	14	35	nsec
Slew Rate	1700	1200	800	V/ μ sec
Output Current	45	25	7	mA

The CLC505's combination of high performance, low power consumption, and large signal performance makes the CLC505 ideal for a wide variety of remote site equipment applications, such as battery powered test instrumentation and communications gear. Some other power applications are video switching matrices, ATE, and phased-array radar systems.

The CLC505 has been designed for ease of use and has been specified to ensure design confidence and final system predictability. The product performance is specified for 1mA, 3mA and 9mA supply current. The CLC505 is available in 8-pin Dip SOIC packages offered for the industrial temperature range.

Enhanced Solutions (Military/Aerospace)

SMD Number: contact factory

Space level versions also available.

For more information, visit <http://www.national.com/mil>

Features

- 10mW power consumption with 50MHz BW
- Single resistor programming of supply current
- 3.4mA I_{CC} provides 100MHz bandwidth and 14ns settling (0.05%)
- Fast disable capability
- 0.04% differential gain at $I_{CC} = 3.4mA$
- 0.06% differential phase at $I_{CC} = 3.4mA$

Applications

- Low power battery applications
- Remote site instrumentation
- Mobile communications gear
- Video switching matrix
- Phased-array radar

Large-Signal Pulse Response

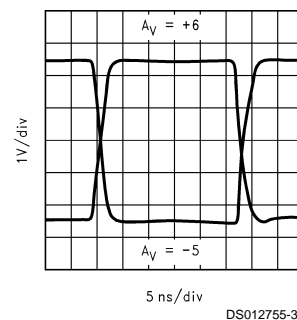

Connection Diagram

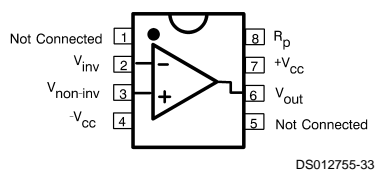

Pinout
DIP & SOIC

Ordering Information

Package	Temperature Range Industrial	Part Number	Package Marking	NSC Drawing
8-pin plastic DIP	-40°C to +85°C	CLC505AJP	CLC505AJP	N08E
8-pin plastic SOIC	-40°C to +85°C	CLC505AJE	CLC505AJE	M08A

Absolute Maximum Ratings (Note 1)

If Military/Aerospace specified devices are required, please contact the National Semiconductor Sales Office/Distributors for availability and specifications.

Supply Voltage (V_{CC}) $\pm 7V$

I_{OUT}
Output is short circuit protected to ground, but maximum reliability will be maintained if I_{OUT} does not exceed...

60mA

Common Mode Input Voltage $\pm V_{CC}$

Differential Input Voltage 10V

Junction Temperature +150°C
Operating Temperature -40°C to +85°C
Storage Temperature Range -65°C to +150°C
Lead Solder Duration (+300°C) 10 sec
ESD rating (human body model) 2000V

Operating Ratings

Thermal Resistance (SOIC)
 θ_{JC} 60°C/W
 θ_{JA} 140°C/W

Electrical Characteristics

$A_V = +6$, $V_{CC} = \pm 5V$, $R_f = 1000\Omega$, $C_p = 100pF$; unless specified

Symbol	Parameter	Conditions	Typ	Max/Min Ratings (Note 2)			Units
Ambient Temperature		CLC505AJ	+25°C	-40°C	+25°C	+85°C	
Frequency Domain Response							
SSBW	-3dB Bandwidth	$V_{OUT} < 2V_{PP}$	150	>115	>115	>100	MHz
LSBW	-3dB Large Signal	$V_{OUT} < 5V_{PP}$	135	>95	>95	>80	MHz
	Gain Flatness	$V_{OUT} < 2V_{PP}$					
GFPL	Peaking	<25/20/10MHz (Note 7)	0	<0.4	<0.3	<0.4	dB
GFPH	Peaking	>25/20/10MHz (Note 7)	0	<0.6	<0.5	<0.6	dB
GFR	Rolloff	<50/40/20MHz (Note 7)	0.2	<1.0	<1.0	<1.3	dB
LPD	Linear Phase Deviation	DC to 50/40/20MHz (Note 7)	0.6	<1.0	<1.0	<1.2	deg
Time Domain Response							
TRS	Rise and Fall Time	2V Step	2.3	<3.0	<3.0	<3.5	ns
TRL		5V Step	2.6	<3.7	<3.7	<4.4	ns
TSP	Settling time to 0.1/0.05/0.05% (Note 7)	2V Step	12	<16	<16	<16	ns
OS	Overshoot	2V Step	5	<15	<12	<15	%
SR	Slew Rate ($A_V + 2$)		1700	>1000	>1200	>1200	V/ μ s
Distortion And Noise Response							
HD2	2nd Harmonic Distortion	$2V_{PP}, 20/10/5MHz$ (Note 7)	-50	<-40	<-45	<-45	dBc
HD3	3rd Harmonic Distortion	$2V_{PP}, 20/10/5MHz$ (Note 7)	-65	<-55	<-55	<-55	dBc
	Equivalent Input Noise						
SNF	Noise Floor	>1MHz	-156	<-154	<-154	<-153	dBm (1Hz)
INV	Integrated Noise	1MHz to 200/200/100MHz (Note 7)	50	<65	<65	<70	μ V
DG	Differential Gain (Note 6)		0.04	-	-	-	%
DP	Differential Phase (Note 6)		0.06	-	-	-	deg
Static, DC Performance							
VIO	Input Offset Voltage (Note 3)		2	< ± 12.8	< ± 8.0	< ± 14	mV
DVIO	Average Temperature Coefficient		30	< ± 50	-	< ± 50	μ V/°C
IBN	Input Bias Current (Note 3)	Non Inverting	8	< ± 36	< ± 18	< ± 18	μ A
DIBN	Average Temperature Coefficient		80	< ± 225	-	< ± 100	nA/°C
IBI	Input Bias Current (Note 3)	Inverting	10	< ± 60	< ± 38	< ± 40	μ A
DIBI	Average Temperature Coefficient		80	< ± 275	-	< ± 125	nA/°C
PSRR	Power Supply Rejection Ratio		50	>45	>48	>45	dB
CMRR	Common Mode Rejection Ratio		50	>45	>48	>45	dB

Electrical Characteristics (Continued)
 $A_V = +6$, $V_{CC} = \pm 5V$, $R_f = 1000\Omega$, $C_p = 100\text{pF}$; unless specified

Symbol	Parameter	Conditions	Typ	Max/Min Ratings (Note 2)			Units
Static, DC Performance							
ICC	Supply Current (Note 3)	No Load, Quiescent	9	<11	<11	<12	mA
Miscellaneous Performance							
RIN	Non-Inverting Input	Resistance	1200	>400	>800	>1600	k Ω
CIN		Capacitance	1	<2	<2	<2	pF
RO	Output Impedence	At DC	0.2	<1.2	<0.3	<0.2	ohm
VO	Output Voltage Range	No Load	± 3.3	> ± 2.8	> ± 3.0	> ± 3.0	V
CMIR	Common Mode Input Range	For Rated Performance	± 2.2	> ± 1.5	> ± 1.8	> ± 2.0	V
IO	Output Current	-40°C to +85°C	± 45	> ± 20	> ± 36	> ± 36	mA

Electrical Characteristics
 $A_V = +6$, $V_{CC} = \pm 5V$, $R_f = 1000\Omega$, $C_p = 100\text{pF}$; unless specified

Symbol	SUPPLY CURRENT I_{CC} (TYP) = 3.4mA $R_p = 100k\Omega$, $R_L = 500\Omega$				SUPPLY CURRENT I_{CC} (TYP) = 1mA $R_p = 300k\Omega$, $R_L = 1000\Omega$				Units
	Typ	Max & Min Ratings			Typ	Max & Min Ratings			
	+25°C	-40°C	+25°C	+85°C	+25°C	-40°C	+25°C	+85°C	
SSBW	100	>80	>80	>65	50	>30	>35	>30	MHz
LSBW	80	>50	>50	>40	33	-1	>20	>18	MHz
GFPL	0	<0.3	<0.2	<0.3	0	<0.2	<0.1	<0.2	dB
GFPH	0	<0.5	<0.4	<0.5	0	<0.3	<0.2	<0.3	dB
GFR	0.2	<1.0	<1.0	<1.3	0.5	<1.0	<1.0	<1.3	dB
LPD	0.5	<1.0	<1.0	<1.2	0.2	<0.5	<0.5	<1.0	deg
TRS	3.5	<4.4	<4.4	<5.4	7	<12	<10	<12	ns
TRL	4.4	<7.0	<7.0	<8.8	9	-1	<18	<20	ns
TSP	14	<22	<22	<22	35	<70	<60	<60	ns
OS	2	<12	<10	<12	0	<8	<5	<8	%
SR	1200	>700	>800	>800	800	>500	>600	>600	V/ μ s
HD2	-55	<-40	<-45	<-45	-55	<-40	<-45	<-45	dBc
HD3	-65	<-55	<-55	<-55	-65	<-55	<-55	<-55	dBc
SNF	-155	<-153	<-153	<-152	-152	<-150	<-150	<-149	dBm (1Hz)
INV	56	<70	<70	<80	55	<70	<70	<80	μ V
DG	0.04	-	-	-	0.1	-	-	-	%
DP	0.06	-	-	-	0.1	-	-	-	deg
VIO	3	< ± 11.8	< ± 7.0	< ± 13	3	< ± 13.0	< ± 7.0	< ± 14.5	mV
DVIO	40	< ± 60	-	< ± 60	50	< ± 75	-	< ± 75	μ V/°C
IBN	2	< ± 12	< ± 6	< ± 6	1	< ± 5.0	< ± 2.5	< ± 2.5	μ A
DIBN	30	< ± 75	-	< ± 50	10	< ± 32	-	< ± 30	nA/°C
IBI	4	< ± 22	< ± 14	< ± 15	2	< ± 10.0	< ± 7.0	< ± 8.0	μ A
DIBI	40	< ± 100	-	< ± 60	20	< ± 38	-	< ± 35	nA/°C
PSRR	50	>45	>48	>45	50	>45	>48	>45	dB
CMRR	50	>45	>48	>45	50	>45	>48	>45	dB
ICC	3.4	<3.8	<3.8	<4.2	1.0	<1.4	<1.3	<1.4	mA
RIN	3000	>1000	>2000	>4000	7500	>2500	>5000	>10000	k Ω
CIN	1	<2	<2	<2	1	<2	<2	<2	pF
RO	0.2	<1.6	<0.5	<0.2	0.5	<3.0	<1.0	<0.5	Ω
VO	± 3.3	> ± 2.8	> ± 2.7	> ± 3.0	± 3.3	> ± 2.5	> ± 3.0	> ± 3.0	V
CMIR	± 2.2	> ± 1.5	> ± 1.8	> ± 2.0	± 2.2	> ± 1.5	> ± 1.8	> ± 2.0	V

Electrical Characteristics (Continued)

$A_V = +6$, $V_{CC} = \pm 5V$, $R_f = 1000\Omega$, $C_p = 100pF$; unless specified

	SUPPLY CURRENT I_{CC} (TYP) = 3.4mA $R_p = 100k\Omega$, $R_L = 500\Omega$				SUPPLY CURRENT I_{CC} (TYP) = 1mA $R_p = 300k\Omega$, $R_L = 1000\Omega$				
IO	± 25	$> \pm 10$	$> \pm 18$	$> \pm 18$	± 7	$> \pm 3.0$	$> \pm 5$	$> \pm 5$	mA
IO	± 25	$> \pm 9$	$> \pm 18$	$> \pm 18$	± 7	$> \pm 2.5$	$> \pm 5$	$> \pm 5$	mA

Note 1: "Absolute Maximum Ratings" are those values beyond which the safety of the device cannot be guaranteed. They are not meant to imply that the devices should be operated at these limits. The table of "Electrical Characteristics" specifies conditions of device operation.

Note 2: Max/min ratings are based on product characterization and simulation. Individual parameters are tested as noted. Outgoing quality levels are determined from tested parameters.

Note 3: AJ-level: spec. is 100% tested at $+25^\circ C = 3.4mA$ & parameter is 100% @ $25^\circ C$ in die form @ $I_{CC} = 1mA, 3.4mA$ and $9mA$.

Note 4: Not applicable due to output current limitations.

Note 5: See Text on the back page of data sheet.

Note 6: Differential gain and phase is characterized with a $1V_{PP}$ equivalent video signal, $0-100 IRE_{PP}$, $40IRE_{PP}$, and $0IRE = 0V$ at the load resistor and $3.58 MHz$.

Note 7: xx/yy/zz MHz indicates that the CLC505 is specified at xxMHz for $I_{CC} = 9mA$, yyMHz for $I_{CC} = 3.4mA$, and zzMHz for $I_{CC} = 1 mA$.

Conditions are different for the three supply currents:

I_{CC}	R_L	R_{OUT}	A_V
9mA	75Ω	75Ω	+2
3.4mA	500Ω	0Ω	+6
1mA	1000Ω	0Ω	+6

Typical Performance Characteristics ($T_A = 25^\circ C$, $A_V = +6$, $V_{CC} = \pm 5V$, $R_f = 1000\Omega$, $V_H = +3V$, $C_p = 100pF$)

$I_{CC} 9mA$, $R_L 250\Omega$

Non-Inverting Gain Circuit

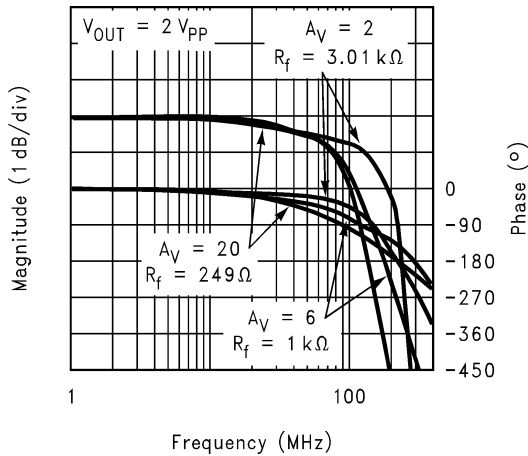

$I_{CC} 3.4mA$, $R_L 500\Omega$

Non-Inverting Gain Circuit

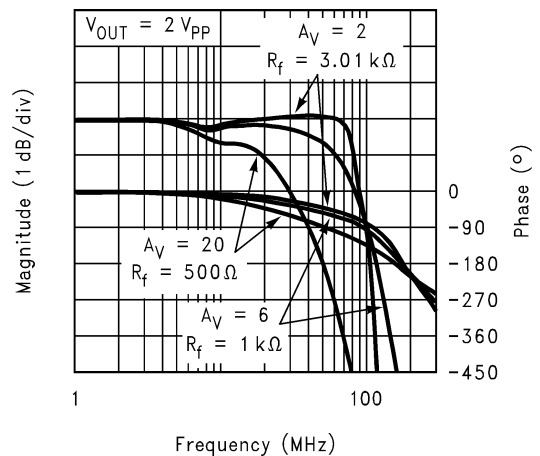

Typical Performance Characteristics ($T_A = 25^\circ\text{C}$, $A_V = +6$, $V_{CC} = \pm 5\text{V}$, $R_f = 1000\Omega$, $V_H = +3\text{V}$, $C_p = 100\text{pF}$) (Continued)

**$I_{CC} 1\text{mA}$, $R_L 1000\Omega$
Non-Inverting Gain Circuit**

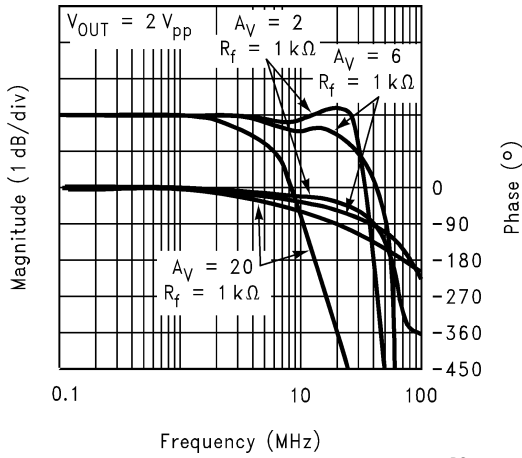

DS012755-3

Inverting Frequency Response

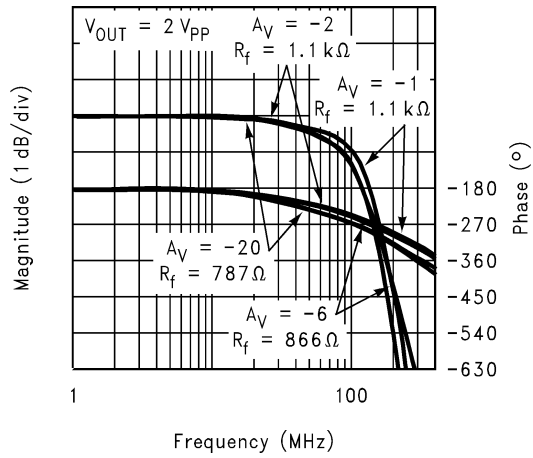

DS012755-4

Inverting Frequency Response

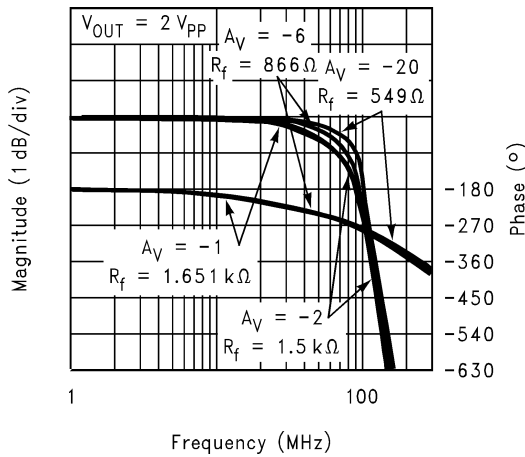

DS012755-5

Inverting Frequency Response

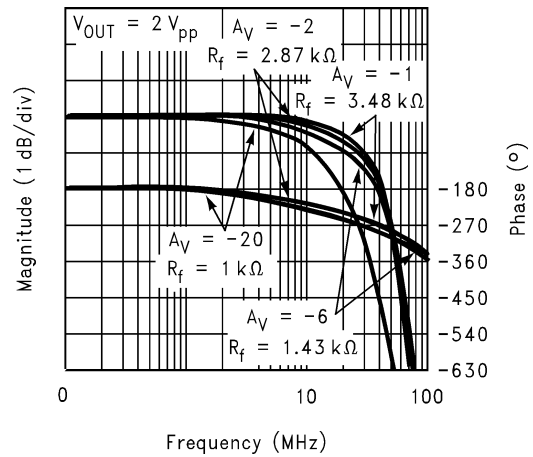

DS012755-6

Large Signal Frequency Response

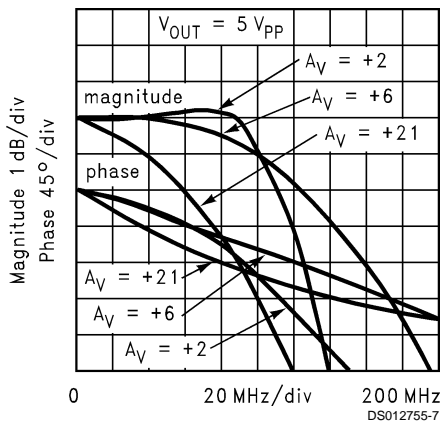

DS012755-7

Large Signal Frequency Response

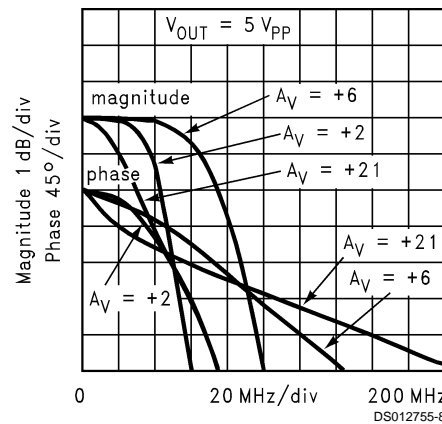

DS012755-8

Typical Performance Characteristics ($T_A = 25^\circ\text{C}$, $A_V = +6$, $V_{CC} = \pm 5\text{V}$, $R_f = 1000\Omega$, $V_H = +3\text{V}$, $C_p = 100\text{pF}$) (Continued)

Large Signal Frequency Response

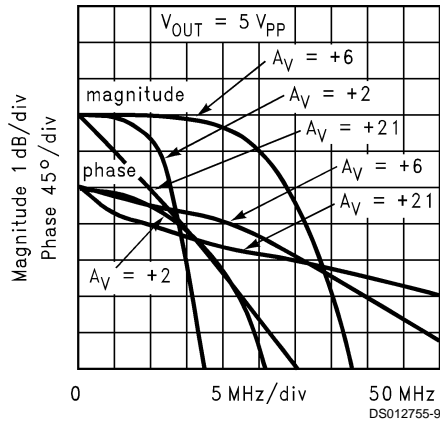

Equivalent Input Noise

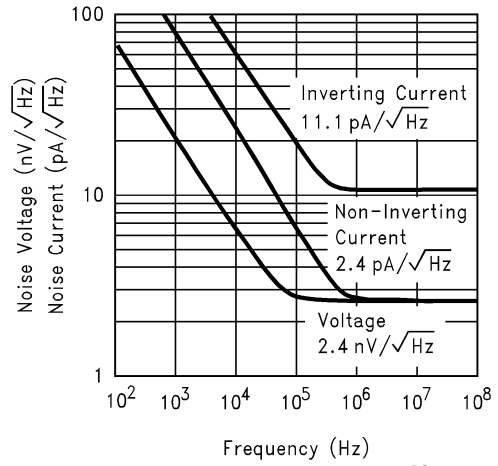

Equivalent Input Noise

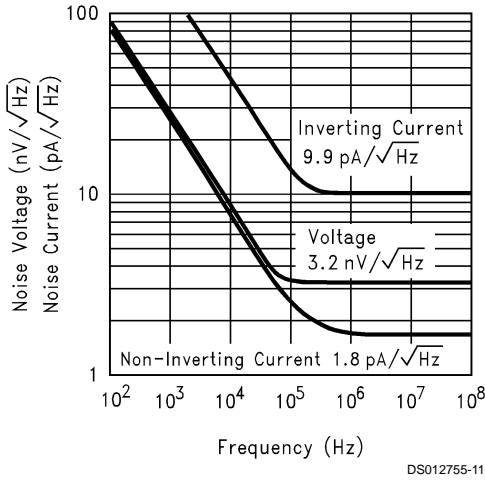

Equivalent Input Noise

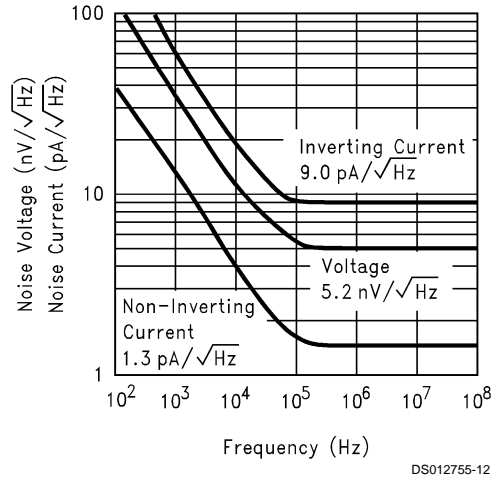

CMRR and PSRR

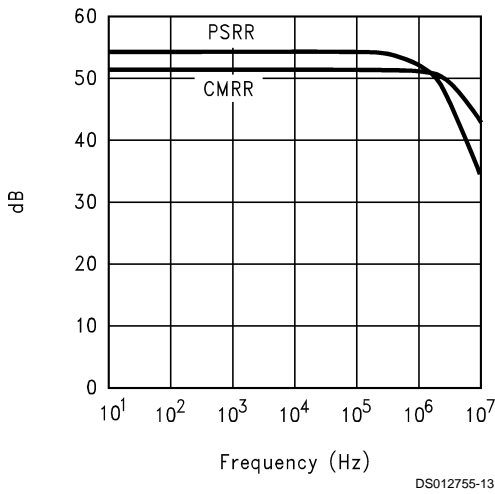

CMRR and PSRR

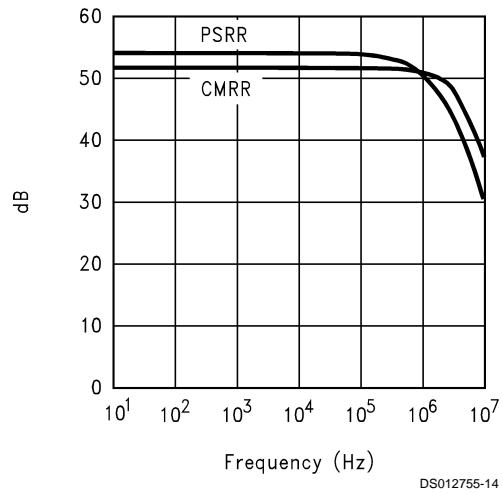

Typical Performance Characteristics ($T_A = 25^\circ\text{C}$, $A_V = +6$, $V_{CC} = \pm 5\text{V}$, $R_f = 1000\Omega$, $V_H = +3\text{V}$, $C_p = 100\text{pF}$) (Continued)

CMRR and PSRR

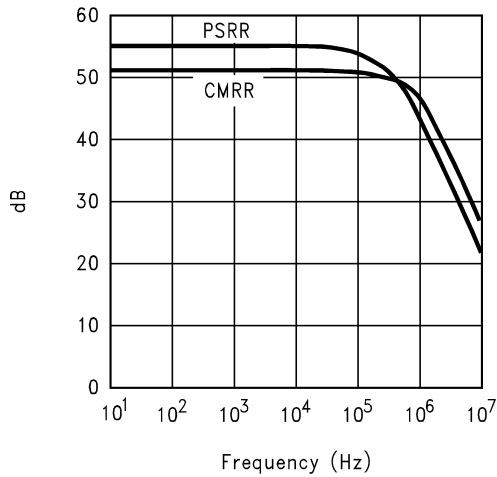

DS012755-15

**$I_{CC} 9\text{mA}$, $R_L 250\Omega$
2nd Harmonic Distortion**

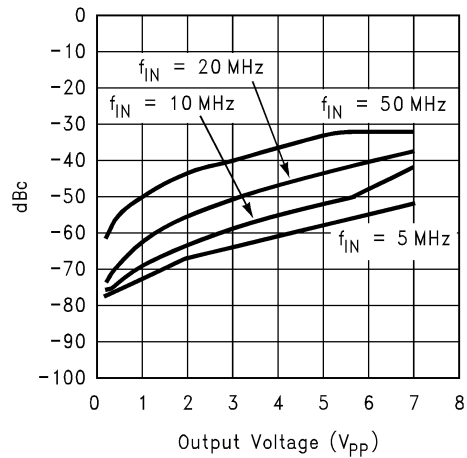

DS012755-16

**$I_{CC} 34\text{mA}$, $R_L 500\Omega$
2nd Harmonic Distortion**

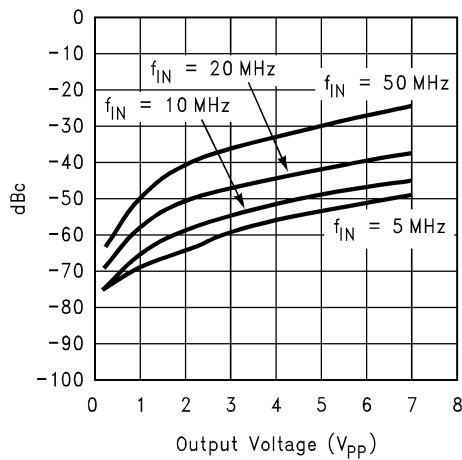

DS012755-17

**$I_{CC} 1\text{mA}$, $R_L 1000\Omega$
2nd Harmonic Distortion**

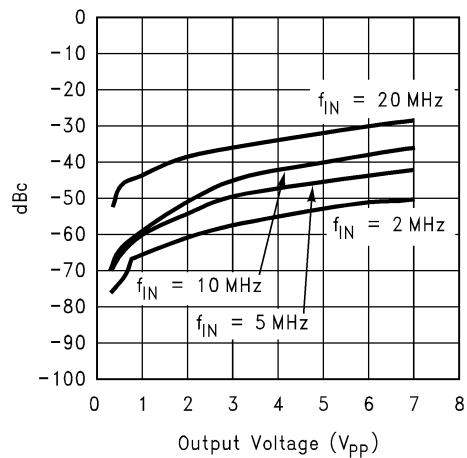

DS012755-18

3rd Harmonic Distortion

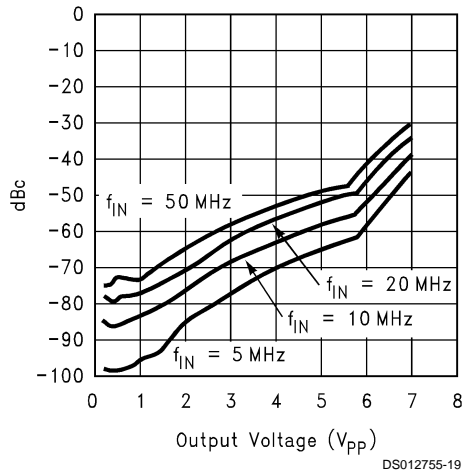

DS012755-19

3rd Harmonic Distortion

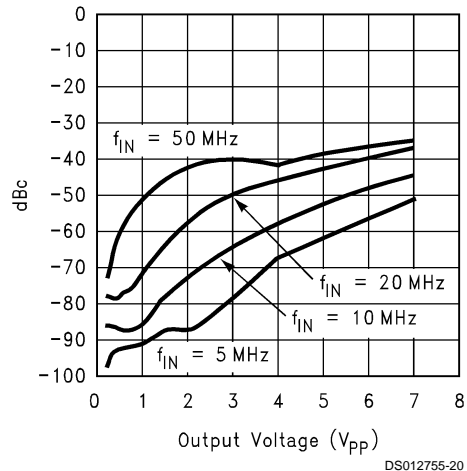

DS012755-20

Typical Performance Characteristics ($T_A = 25^\circ\text{C}$, $A_V = +6$, $V_{CC} = \pm 5\text{V}$, $R_f = 1000\Omega$, $V_H = +3\text{V}$, $C_p = 100\text{pF}$) (Continued)

3rd Harmonic Distortion

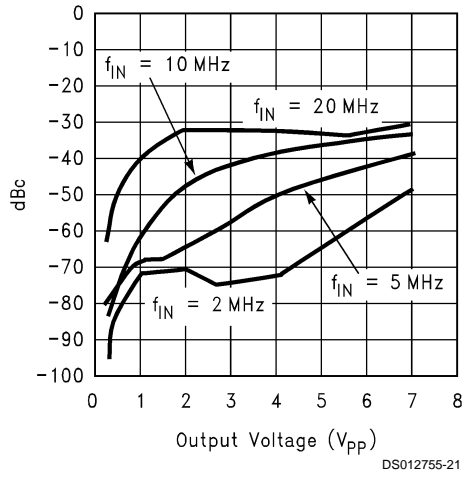

Bandwidth vs. Load Capacitance

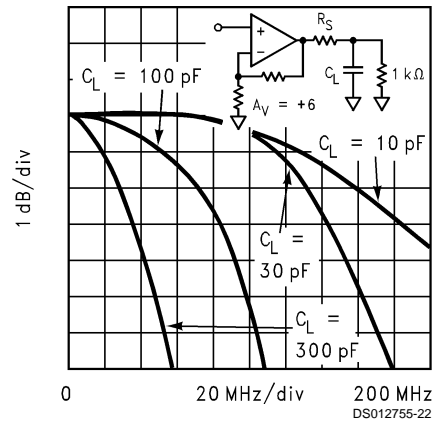

Bandwidth vs. Load Capacitance

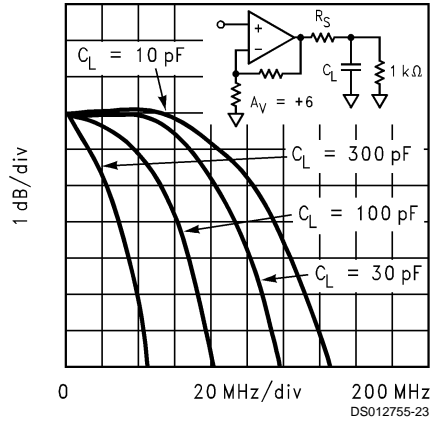

Bandwidth vs. Load Capacitance

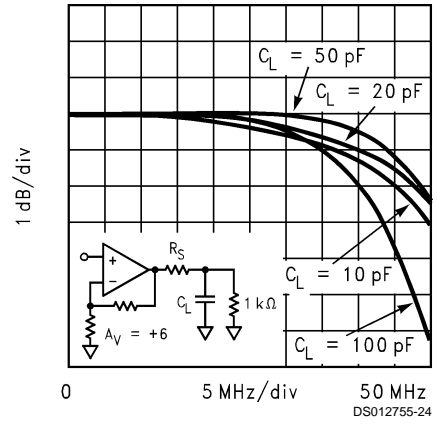

Recommended R_S vs. Load Capacitance

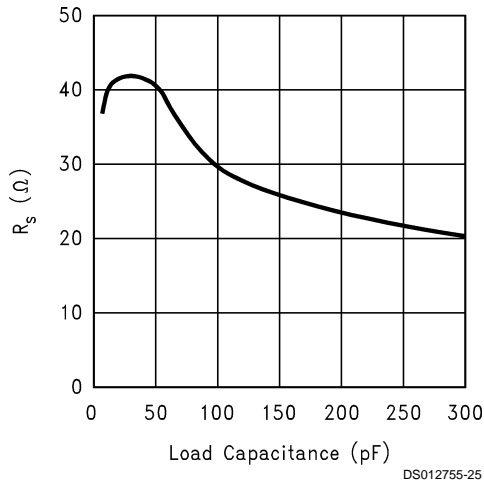

Recommended R_S vs. Load Capacitance

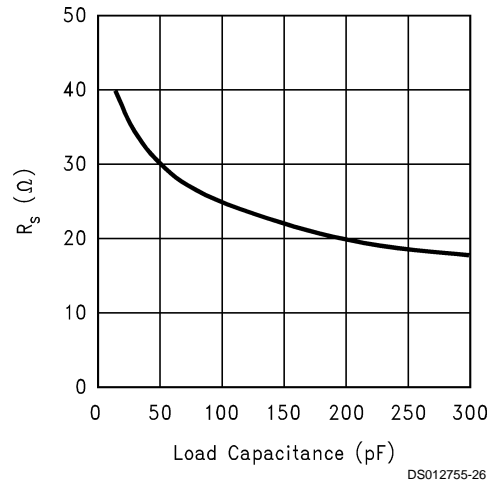

Typical Performance Characteristics ($T_A = 25^\circ\text{C}$, $A_V = +6$, $V_{CC} = \pm 5\text{V}$, $R_f = 1000\Omega$, $V_H = +3\text{V}$, $C_p = 100\text{pF}$) (Continued)

Recommended R_S vs. Load Capacitance

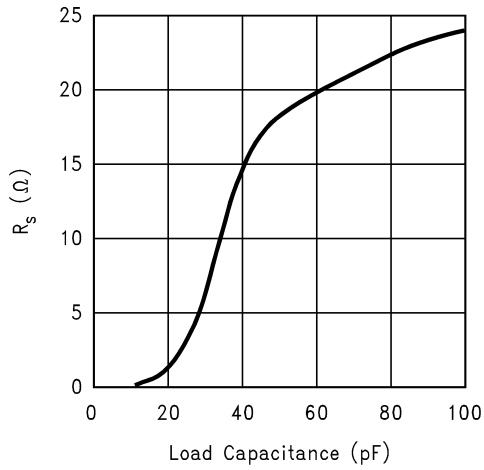

DS012755-27

Settling Time

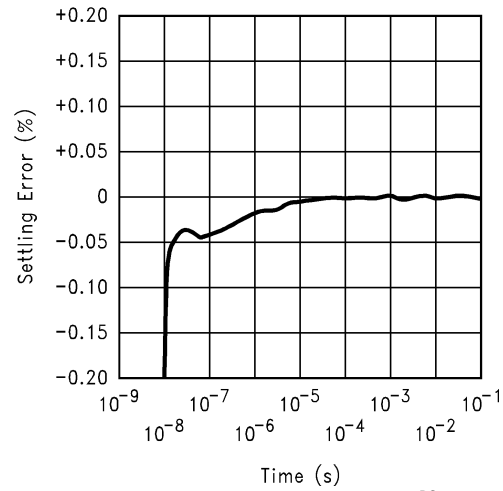

DS012755-28

Settling Time

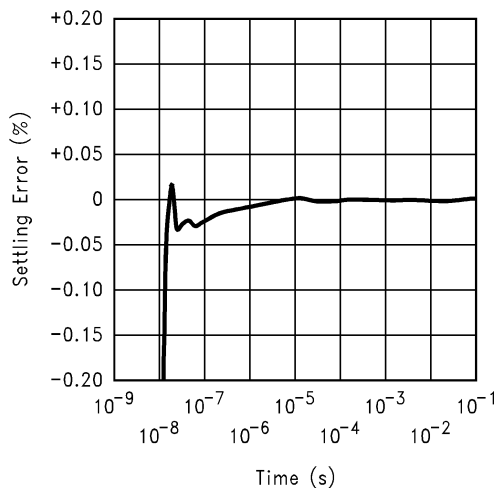

DS012755-29

Settling Time

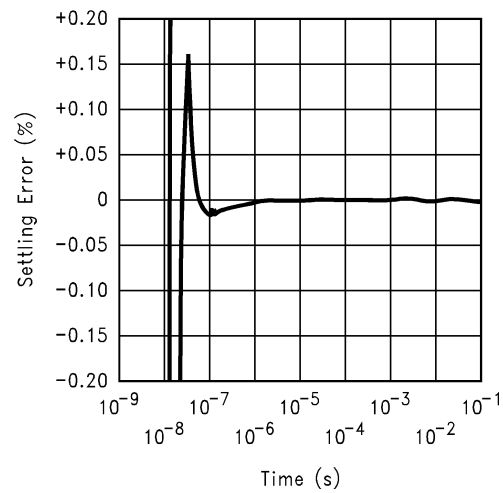

DS012755-30

**$I_{CC} 9\text{mA}$, $R_L 250\Omega$
Small-Signal Pulse Response**

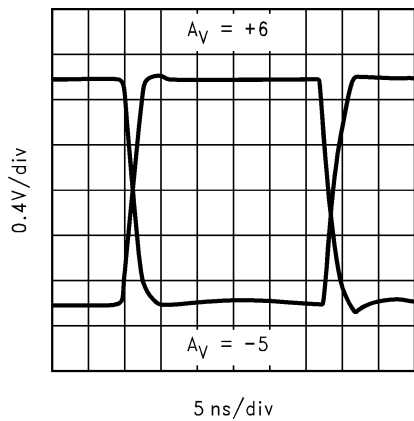

DS012755-34

**$I_{CC} 34\text{mA}$, $R_L 500\Omega$
Small-Signal Pulse Response**

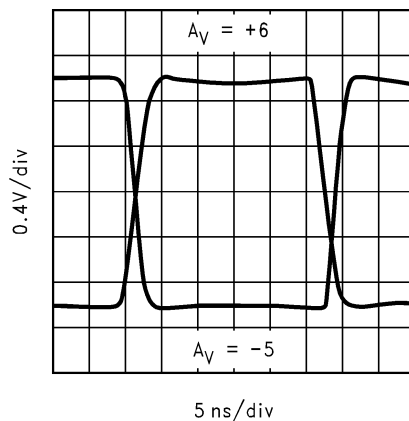

DS012755-35

Typical Performance Characteristics ($T_A = 25^\circ\text{C}$, $A_V = +6$, $V_{CC} = \pm 5\text{V}$, $R_f = 1000\Omega$, $V_H = +3\text{V}$, $C_p = 100\text{pF}$) (Continued)

$I_{CC} 1\text{mA}$, $R_L 1000\Omega$
Small-Signal Pulse Response

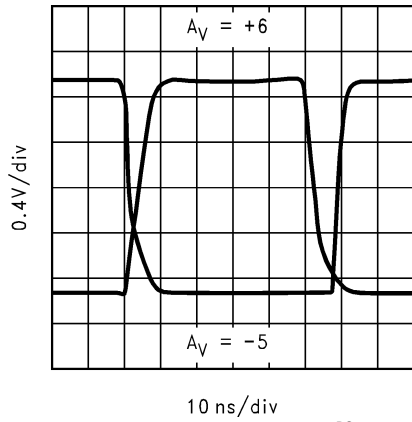

DS012755-36

Large-Signal Pulse Response

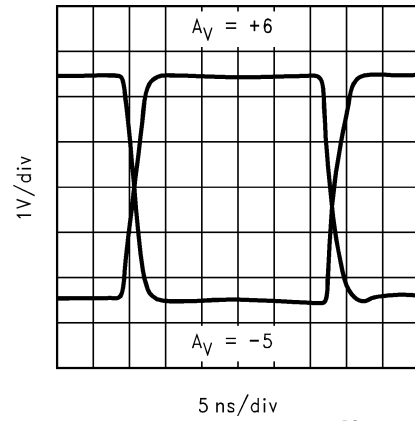

DS012755-37

Large-Signal Pulse Response

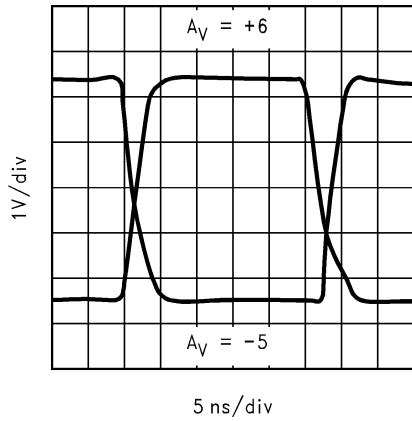

DS012755-38

Large-Signal Pulse Response

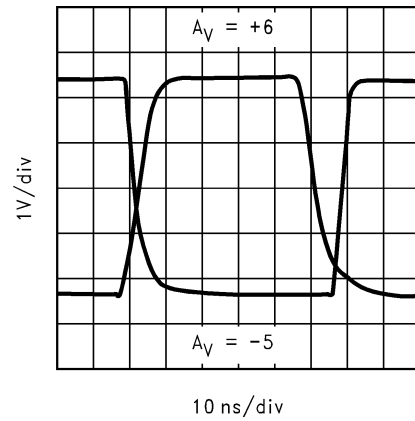

DS012755-39

I_{CC} vs. R_P

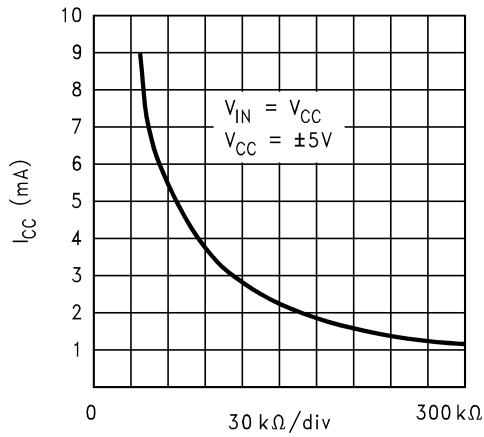

DS012755-40

I_{CC} vs. I_P

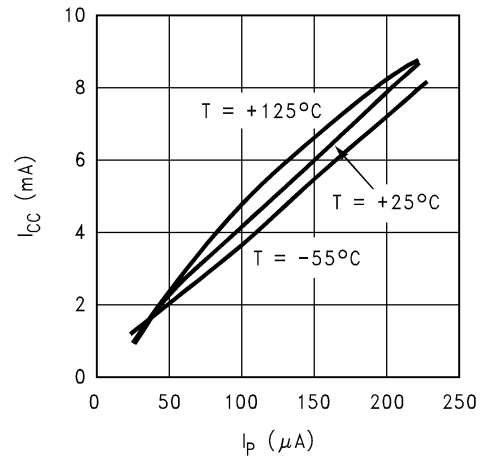

DS012755-41

Typical Performance Characteristics ($T_A = 25^\circ\text{C}$, $A_V = +6$, $V_{CC} = \pm 5\text{V}$, $R_f = 1000\Omega$, $V_H = +3\text{V}$, $C_p = 100\text{pF}$) (Continued)

Bandwidth vs. I_{CC}

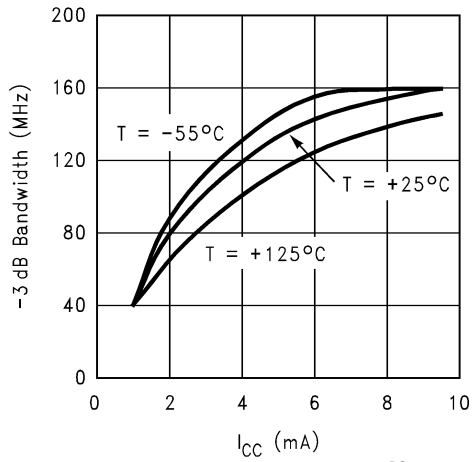

Maximum Output Current vs. I_{CC}

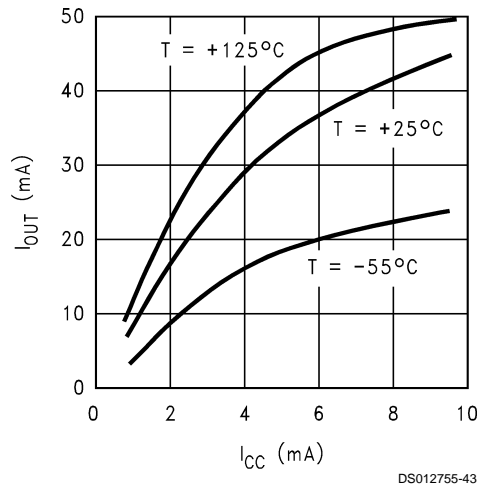

Offset Voltage vs. I_{CC}

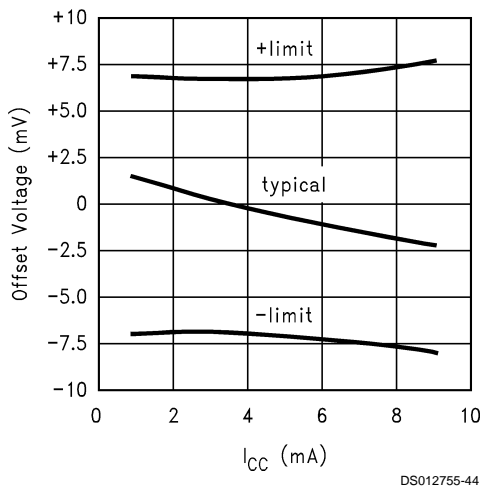

Slew Rate vs. I_{CC}

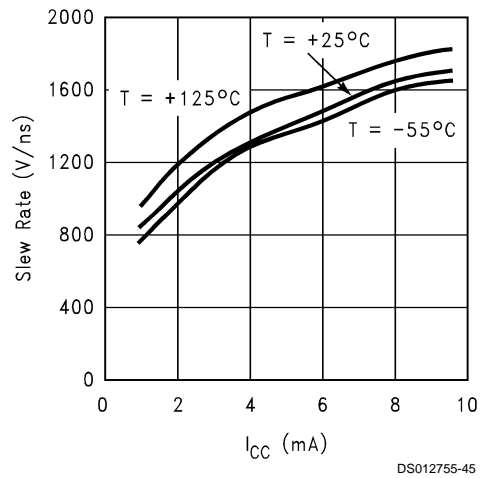

Non-Inverting Bias Current vs. I_{CC}

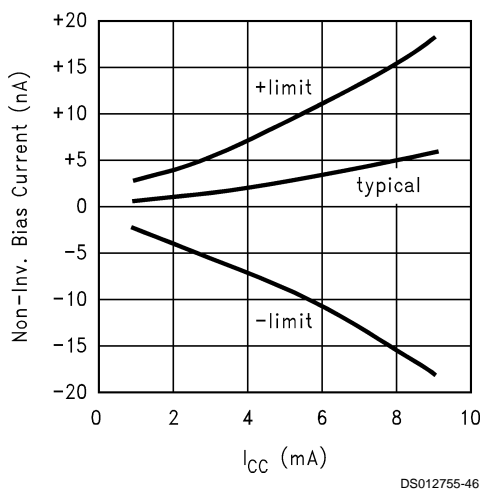

Inverting Bias Current vs. I_{CC}

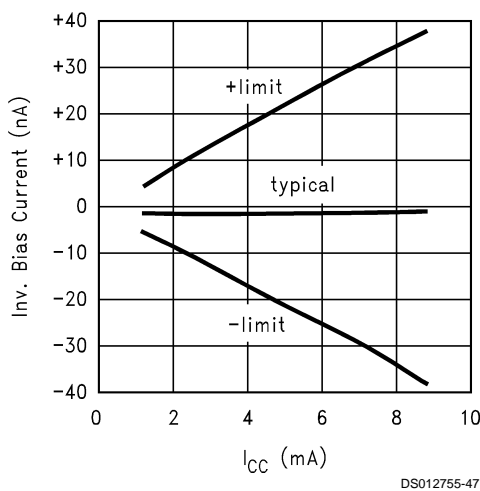

Typical Performance Characteristics ($T_A = 25^\circ\text{C}$, $A_V = +6$, $V_{CC} = \pm 5\text{V}$, $R_f = 1000\Omega$, $V_H = +3\text{V}$, $C_p = 100\text{pF}$) (Continued)

Differential Gain and Phase vs. Load

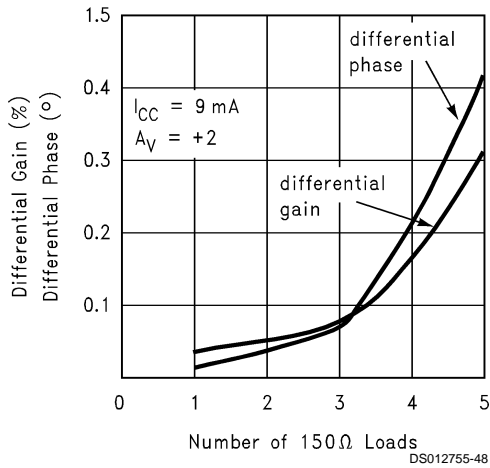

Application Information

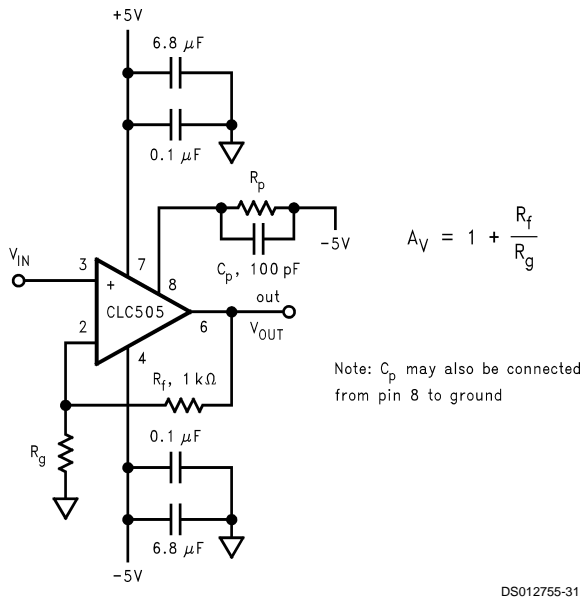

FIGURE 1. Recommended Non-Inverting Gain Circuit

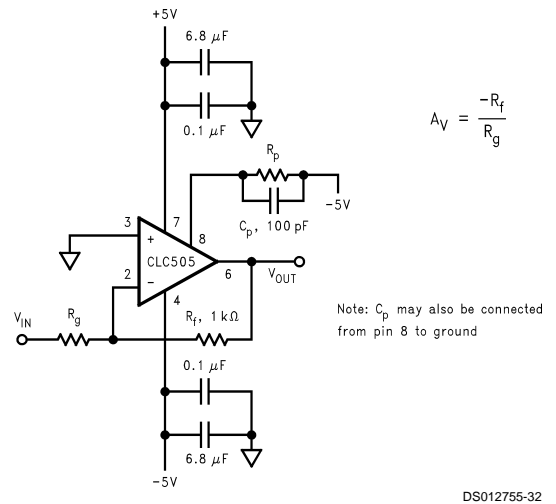

FIGURE 2. Recommended Inverting Gain Circuit

Description

The CLC505 is a programmable-supply current, current-feedback operational amplifier. Supply current and consequently dynamic performance can be easily adjusted by selecting the value of a single external resistor (R_p).

Application Information (Continued)

Selecting an Operating Point

The operating point is determined by the supply current, which in turn is determined by current (I_p) flowing out of pin 8. As the supply current is reduced the following effects will be observed:

Specification	Effect as I_{CC} Decreases
Bandwidth	Decreases
Rise Time	increases
Output Drive	Decreases
Input Bias Current	Decreases
Input Impedance	Increases (see source impedance discussion)

Both the specification pages and the plot pages illustrate these effects to help make the supply current vs. performance tradeoff. Performance is specified and tested at $I_{CC} = 1\text{mA}$, 3.4mA , and 9mA as indicated in the datasheet. (Note some test conditions and especially the load resistance are different for the three supply current settings.) The performance plots show typical performance for all three supply currents levels.

When making the supply current vs. performance tradeoff, it is first a good idea to see if one of the standard operating points ($I_{CC} = 9\text{mA}$, 3.4mA , or 1mA) fits the application. If it does, performance guaranteed on the specification pages will apply directly to your application. In addition, the value of R_p may be obtained directly from the specification page.

The following discussion will assist in selecting I_{CC} for applications that cannot operate at one of the specified supply current settings.

Use the typical performance plots for critical specifications to select the best I_{CC} . Now interpolate between the values of I_{CC} in the plots & specification tables to estimate the max/min values in the application.

From the selected value of I_{CC} the "programming current" (I_p) may be easily calculated:

$$I_p = I_{CC}/39$$

The plot of I_{CC} vs I_p in the plot pages shows this relationship graphically. Knowing I_p leads to a direct calculation of R_p .

$$R_p = [(+V_{CC} - 1.6V) - V_n] / I_p$$

$$R_p = 8.4 / I_p \text{ (for } +V_{CC} = +5V \text{ and } V_n = -5V)$$

V_n is the voltage externally applied to R_p . (Throughout the data sheet and in most applications, V_n and $-V_{CC}$ are $-5V$.) The term $(+V_{CC} - 1.6V)$ is the voltage at pin 8.

Now standard V_{CC} , V_{EE} and R_p does not have to be connected to $-V_{CC}$. In applications where non-standard supply voltages are used or when there is a need to power down the op amp via digital logic control. The value of R_p is adjusted accordingly.

First, an operating point needs to be determined from the plots & specifications as discussed above. From this, I_p is obtained. I_p , in concert with the available V_n determines R_p .

Example

An application requires that $V_{CC} = \pm 3V$ and performance in the 1mA operating point range. The required I_p can therefore be determined as follows:

$$I_p = 26\mu\text{A}$$

R_p is connected from pin 8 to $-V_{CC}$ and $V_{CC} = \pm 3V$. Now calculate R_p under new conditions:

$$R_p = [(+V_{CC} - 1.6V) - (-V_{CC})] / I_p$$

$$R_p = [(+3V - 1.6V) - (-3V)] / 26\mu\text{A}$$

$$R_p = 169\text{k}\Omega$$

The CLC505 will have performance similar to $R_p = 300\text{k}\Omega$ shown on the datasheet, but with 40% less power dissipation due to the reduced supply voltages. (The op amp will also have a more restricted common-mode range and output swing.) This calculation is approximate and a prudent design would include substantial performance margin for max/min limits.

Dynamic Shutdown Capability

The CLC505 may be powered on and off very quickly by controlling the voltage applied to R_p . If R_p is connected between pin 8 and the output of a CMOS gate powered from $\pm 5V$ supplies, the gate can be used to turn the amplifier on and off. This is shown in *Figure 3* below:

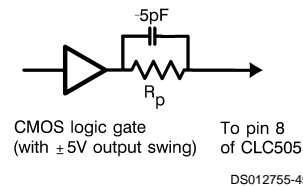

FIGURE 3. Dynamic Control of Power Consumption

When the gate output is switched from high to low, the CLC505 will turn on. In the off state, the supply current typically reduces to 0.2mA or less. The speed with which the CLC505 turns on or off is limited by the capacitance at pin 8. To improve switching time, a speed up capacitor from the gate output to pin 8 is recommended. The value of this capacitor will depend on the total capacitance connected to pin 8 and is best established experimentally. Turn-on and turn-off times of 100ns to 200ns are achievable with ordinary CMOS gates.

Example:

An open collector logic device is used to dynamically control the power dissipation of the circuit. Here, the desired connection for R_p is from pin 8 to the open collector logic device.

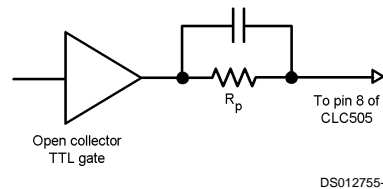

FIGURE 4. Controlling Power on State with TTL Logic

When the logic gate goes low, the CLC505 is turned on. Performance desired is that given for $I_{CC} = 3.4\text{mA}$ under standard conditions. From the I_{CC} vs. I_p plot, $I_p = 84\mu\text{A}$. Then calculating R_p :

$$R_p = [(+V_{CC} - 1.6V) - (V_n)] / I_p$$

$$R_p = [(+5V - 1.6V) - (0)] / 84\mu\text{A}$$

$$R_p = 40\text{k}\Omega$$

Application Information (Continued)

Slew Rate

The rapid turn on and off ability of the CLC505 is not recommended for signal isolation applications (such as multiplexing). While the power dissipation of the amplifier drops in the off state, the amplifier may still have some gain at low frequencies. Causing feed through in multiplex application.

The performance desired is that given for $I_{CC} = 3.4\text{mA}$ under standard conditions. From the I_{CC} vs. I_p plot, $I_p = 84\mu\text{A}$. Is obtained now calculating R_p :

Slew rate limiting is a nonlinear response which occurs in amplifiers when the output voltage swing cannot change as rapidly as the applied input signal. The CLC505 has been designed to avoid slew rate limiting in most circuit configurations. The large signal ($5V_{PP}$) bandwidth of 80MHz at $I_{CC} = 3.4\text{mA}$, is only slightly less than the 100MHz small signal bandwidth. The result is a low distortion, linear system for both small and large signals over the required system frequency range.

The CLC505 reaches slew rate limits only for small non-inverting gains. In other words, slew rate limiting is constrained by common mode voltage swings at the input. The large signal frequency response plot at a gain of +2 was a break in the response, which indicates that a slew rate limit has been reached. Note also that the frequency response plots at a gain of +21 for large and small signal responses are nearly identical.

Differential Gain and Phase

Differential gain and phase are measurements useful primarily in composite video channels. They are measured by monitoring the gain and phase changes of a high frequency carrier (3.58MHz typically) as the output of the amplifier is swept over a range of DC voltages.

Specifications for the CLC505 include differential gain and phase. Test signals based on a $1V_{PP}$ video level. Test conditions used are the following:

DC sweep range: 0 to 100 IRE units (black to white)

Carrier: 3.58MHz at 40 IRE units peak to peak

The amplifier conditions are significantly different for the three values of supply current specified. At $I_{CC} = 9\text{mA}$, the amplifier is specified for a gain of +2 and 150Ω load (for a backmatched 75Ω system). IRE amplitudes at $I_{CC} = 9\text{mA}$, are referred to the 75Ω load resistor.

At $I_{CC} = 1\text{mA}$ and $I_{CC} = 3.4\text{mA}$, the CLC505 is less capable of driving a 150Ω load due to output current limitations. For this reason lighter loads are used and the termination resistor is omitted. The gain and load resistance for $I_{CC} = 3.4\text{mA}$ are $A_V = +6$ and $R_L = 500\Omega$ and for $I_{CC} = 1\text{mA}$; $A_V = +6$ and $R_L = 1\text{k}\Omega$.

Source Impedance

For best results, source impedance in the non-inverting circuit configuration (see *Figure 1*) should be kept below $5\text{k}\Omega$. Above $5\text{k}\Omega$ it is possible for oscillation to occur, depending on other circuit board parasitics. For high signal source impedances, a resistor with a value of less than $5\text{k}\Omega$ may be used to terminate the non-inverting input to ground.

Feedback Resistor

In current-feedback op amps, the value of the feedback resistor plays a major role in determining amplifier dynamics. It is important to select the correct value. The CLC505 provides optimum performance with a $1\text{k}\Omega$ feedback resistor. Selection of an incorrect value can lead to severe rolloff in frequency response, (if the resistor value is too large) or peaking or oscillation, (if the value is too low.)

Printed Circuit Layout

As with any high frequency device, a good PCB layout will enhance performance. Ground plane construction and good power supply bypassing close to the package are critical to achieving full performance. In the non-inverting configuration, the amplifier is sensitive to stray capacitance to ground at the inverting input. Hence, the inverting node connections should be small with minimal coupling to the ground plane. Shunt capacitance across the feedback resistor should not be used to compensate for this effect.

Precision buffered resistors (PRP8351 series from Precision Resistive Products) with low parasitic reactances were used to develop the data sheet specifications. Precision carbon composition resistors will also yield excellent results. Standard spirally-trimmed RN55D metal film resistors will work with a slight decrease in bandwidth due to their reactive nature at high frequencies.

Evaluation PC boards (part number 730013 for through-hole and 730027 for SOIC) for the CLC505 are available.

Physical Dimensions inches (millimeters) unless otherwise noted

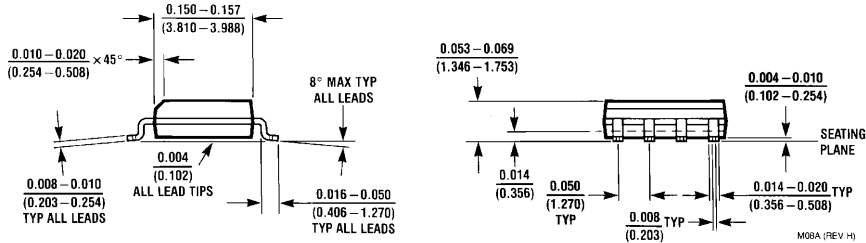
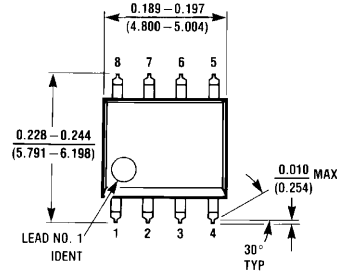

8-Pin SOIC
NS Package Number M08A

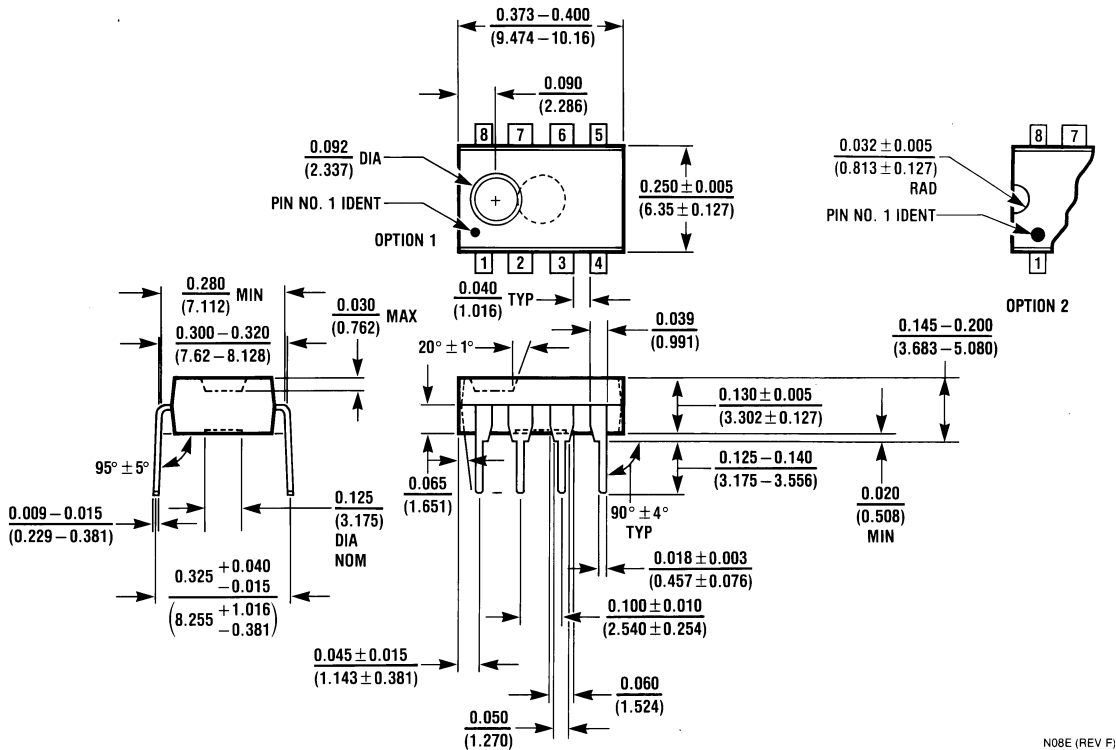

8-Pin MDIP
NS Package Number N08E

Notes

LIFE SUPPORT POLICY

NATIONAL'S PRODUCTS ARE NOT AUTHORIZED FOR USE AS CRITICAL COMPONENTS IN LIFE SUPPORT DEVICES OR SYSTEMS WITHOUT THE EXPRESS WRITTEN APPROVAL OF THE PRESIDENT AND GENERAL COUNSEL OF NATIONAL SEMICONDUCTOR CORPORATION. As used herein:

1. Life support devices or systems are devices or systems which, (a) are intended for surgical implant into the body, or (b) support or sustain life, and whose failure to perform when properly used in accordance with instructions for use provided in the labeling, can be reasonably expected to result in a significant injury to the user.
2. A critical component is any component of a life support device or system whose failure to perform can be reasonably expected to cause the failure of the life support device or system, or to affect its safety or effectiveness.



National Semiconductor Corporation
Americas
Tel: 1-800-272-9959
Fax: 1-800-737-7018
Email: support@nsc.com
www.national.com

National Semiconductor Europe
Fax: +49 (0) 180-530 85 86
Email: europe.support@nsc.com
Deutsch Tel: +49 (0) 69 9508 6208
English Tel: +44 (0) 870 24 0 2171
Français Tel: +33 (0) 1 41 91 8790

National Semiconductor Asia Pacific Customer Response Group
Tel: 65-2544466
Fax: 65-2504466
Email: ap.support@nsc.com

National Semiconductor Japan Ltd.
Tel: 81-3-5639-7560
Fax: 81-3-5639-7507

IMPORTANT NOTICE

Texas Instruments Incorporated and its subsidiaries (TI) reserve the right to make corrections, modifications, enhancements, improvements, and other changes to its products and services at any time and to discontinue any product or service without notice. Customers should obtain the latest relevant information before placing orders and should verify that such information is current and complete. All products are sold subject to TI's terms and conditions of sale supplied at the time of order acknowledgment.

TI warrants performance of its hardware products to the specifications applicable at the time of sale in accordance with TI's standard warranty. Testing and other quality control techniques are used to the extent TI deems necessary to support this warranty. Except where mandated by government requirements, testing of all parameters of each product is not necessarily performed.

TI assumes no liability for applications assistance or customer product design. Customers are responsible for their products and applications using TI components. To minimize the risks associated with customer products and applications, customers should provide adequate design and operating safeguards.

TI does not warrant or represent that any license, either express or implied, is granted under any TI patent right, copyright, mask work right, or other TI intellectual property right relating to any combination, machine, or process in which TI products or services are used. Information published by TI regarding third-party products or services does not constitute a license from TI to use such products or services or a warranty or endorsement thereof. Use of such information may require a license from a third party under the patents or other intellectual property of the third party, or a license from TI under the patents or other intellectual property of TI.

Reproduction of TI information in TI data books or data sheets is permissible only if reproduction is without alteration and is accompanied by all associated warranties, conditions, limitations, and notices. Reproduction of this information with alteration is an unfair and deceptive business practice. TI is not responsible or liable for such altered documentation. Information of third parties may be subject to additional restrictions.

Resale of TI products or services with statements different from or beyond the parameters stated by TI for that product or service voids all express and any implied warranties for the associated TI product or service and is an unfair and deceptive business practice. TI is not responsible or liable for any such statements.

TI products are not authorized for use in safety-critical applications (such as life support) where a failure of the TI product would reasonably be expected to cause severe personal injury or death, unless officers of the parties have executed an agreement specifically governing such use. Buyers represent that they have all necessary expertise in the safety and regulatory ramifications of their applications, and acknowledge and agree that they are solely responsible for all legal, regulatory and safety-related requirements concerning their products and any use of TI products in such safety-critical applications, notwithstanding any applications-related information or support that may be provided by TI. Further, Buyers must fully indemnify TI and its representatives against any damages arising out of the use of TI products in such safety-critical applications.

TI products are neither designed nor intended for use in military/aerospace applications or environments unless the TI products are specifically designated by TI as military-grade or "enhanced plastic." Only products designated by TI as military-grade meet military specifications. Buyers acknowledge and agree that any such use of TI products which TI has not designated as military-grade is solely at the Buyer's risk, and that they are solely responsible for compliance with all legal and regulatory requirements in connection with such use.

TI products are neither designed nor intended for use in automotive applications or environments unless the specific TI products are designated by TI as compliant with ISO/TS 16949 requirements. Buyers acknowledge and agree that, if they use any non-designated products in automotive applications, TI will not be responsible for any failure to meet such requirements.

Following are URLs where you can obtain information on other Texas Instruments products and application solutions:

Products

Audio	www.ti.com/audio
Amplifiers	amplifier.ti.com
Data Converters	dataconverter.ti.com
DLP® Products	www.dlp.com
DSP	dsp.ti.com
Clocks and Timers	www.ti.com/clocks
Interface	interface.ti.com
Logic	logic.ti.com
Power Mgmt	power.ti.com
Microcontrollers	microcontroller.ti.com
RFID	www.ti-rfid.com
OMAP Mobile Processors	www.ti.com/omap
Wireless Connectivity	www.ti.com/wirelessconnectivity

Applications

Communications and Telecom	www.ti.com/communications
Computers and Peripherals	www.ti.com/computers
Consumer Electronics	www.ti.com/consumer-apps
Energy and Lighting	www.ti.com/energy
Industrial	www.ti.com/industrial
Medical	www.ti.com/medical
Security	www.ti.com/security
Space, Avionics and Defense	www.ti.com/space-avionics-defense
Transportation and Automotive	www.ti.com/automotive
Video and Imaging	www.ti.com/video

TI E2E Community Home Page

e2e.ti.com

Mailing Address: Texas Instruments, Post Office Box 655303, Dallas, Texas 75265
Copyright © 2011, Texas Instruments Incorporated