

## LMH6502 Wideband, Low Power, Linear-in-dB Variable Gain Amplifier

Check for Samples: [LMH6502](#)

### FEATURES

- $V_S = \pm 5V$ ,  $T_A = 25^\circ C$ ,  $R_F = 1k\Omega$ ,  $R_G = 174\Omega$ ,  $R_L = 100\Omega$ ,  $A_V = A_{V(MAX)} = 10$  Typical Values Unless Specified.
- -3dB BW: 130MHz
- Gain Control BW: 100MHz
- Adjustment Range (Typical Over Temp): 70dB
- Gain Matching (Limit):  $\pm 0.6dB$
- Slew Rate: 1800V/ $\mu s$
- Supply Current (No Load): 27mA
- Linear Output Current:  $\pm 75mA$
- Output Voltage ( $R_L = 100\Omega$ ):  $\pm 3.2V$
- Input Voltage Noise: 7.7nV/ $\sqrt{Hz}$
- Input Current Noise: 2.4pA/ $\sqrt{Hz}$
- THD (20MHz,  $R_L = 100\Omega$ ,  $V_O = 2V_{PP}$ ): -53dBc
- Replacement for CLC520

### APPLICATIONS

- Variable Attenuator
- AGC
- Voltage Controller Filter
- Video Imaging Processing

### DESCRIPTION

The LMH<sup>TM</sup>6502 is a wideband DC coupled differential input voltage controlled gain stage followed by a high-speed current feedback Op Amp which can directly drive a low impedance load. Gain adjustment range is more than 70dB for up to 10MHz.

Maximum gain is set by external components and the gain can be reduced all the way to cut-off. Power consumption is 300mW with a speed of 130MHz. Output referred DC offset voltage is less than 350mV over the entire gain control voltage range. Device-to-device Gain matching is within  $\pm 0.6dB$  at maximum gain. Furthermore, gain at any  $V_G$  is tested and the tolerance is ensured. The output current feedback Op Amp allows high frequency large signals (Slew Rate = 1800V/ $\mu s$ ) and can also drive heavy load current (75mA). Differential inputs allow common mode rejection in low level amplification or in applications where signals are carried over relatively long wires. For single ended operation, the unused input can easily be tied to ground (or to a virtual half-supply in single supply application). Inverting or non-inverting gains could be obtained by choosing one input polarity or the other.

To provide ease of use when working with a single supply,  $V_G$  range is set to be from 0V to +2V relative to pin 11 potential (ground pin). In single supply operation, this ground pin is tied to a "virtual" half supply.

LMH6502 gain control is linear in dB for a large portion of the total gain control range. This makes the device suitable for AGC circuits among other applications. For linear gain control applications, see the LMH6503 datasheet. The LMH6502 is available in the SOIC and TSSOP package.



Please be aware that an important notice concerning availability, standard warranty, and use in critical applications of Texas Instruments semiconductor products and disclaimers thereto appears at the end of this data sheet.

LMH is a trademark of Texas Instruments.

All other trademarks are the property of their respective owners.

Typical Application

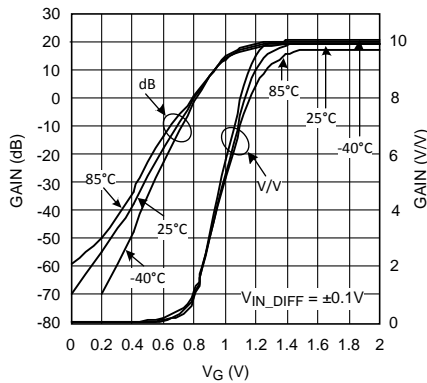

Figure 1. Gain vs.  $V_G$  for Various Temperature

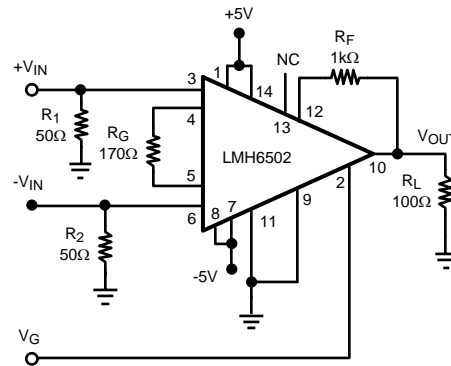

Figure 2.  $A_{VMAX} = 10V/V$



These devices have limited built-in ESD protection. The leads should be shorted together or the device placed in conductive foam during storage or handling to prevent electrostatic damage to the MOS gates.

Absolute Maximum Ratings<sup>(1)(2)</sup>

ESD Tolerance <sup>(3)</sup> :	Human Body	2KV
	Machine Model	200V
Input Current		±10mA
$V_{IN}$ Differential		±( $V^+ - V^-$ )
Output Current		120mA <sup>(4)</sup>
Supply Voltages ( $V^+ - V^-$ )		12.6V
Voltage at Input/ Output pins		$V^+ +0.8V, V^- - 0.8V$
Storage Temperature Range		-65°C to +150°C
Junction Temperature		+150°C
Soldering Information:	Infrared or Convection (20 sec)	235°C
	Wave Soldering (10 sec)	260°C

- (1) Absolute Maximum Ratings indicate limits beyond which damage to the device may occur. Operating Ratings indicate conditions for which the device is intended to be functional, but specific performance is not ensured. For specific specifications, see the Electrical Characteristics tables.
- (2) If Military/Aerospace specified devices are required, please contact the Texas Instruments Sales Office/Distributors for availability and specifications.
- (3) Human body model: 1.5kΩ in series with 100pF. Machine model: 0Ω in series with 200pF.
- (4) The maximum output current ( $I_{OUT}$ ) is determined by device power dissipation limitations or value specified, whichever is lower.

Operating Ratings<sup>(1)</sup>

Supply Voltages ( $V^+ - V^-$ )		5V to 12V	
Temperature Range		-40°C to +85°C	
Thermal Resistance:	14-Pin SOIC	( $\theta_{JC}$ )	45°C/W
		( $\theta_{JA}$ )	138°C/W
	14-Pin TSSOP	( $\theta_{JC}$ )	51°C/W
		( $\theta_{JA}$ )	160°C/W

- (1) Absolute Maximum Ratings indicate limits beyond which damage to the device may occur. Operating Ratings indicate conditions for which the device is intended to be functional, but specific performance is not ensured. For specific specifications, see the Electrical Characteristics tables.

**Electrical Characteristics<sup>(1)</sup>**

Unless otherwise specified, all limits specified for  $T_J = 25^\circ\text{C}$ ,  $V_S = \pm 5\text{V}$ ,  $A_{V(\text{MAX})} = 10$ ,  $V_{\text{CM}} = 0\text{V}$ ,  $R_F = 1\text{k}\Omega$ ,  $R_G = 174\Omega$ ,  $V_{\text{IN\_DIFF}} = \pm 0.1\text{V}$ ,  $R_L = 100\Omega$ ,  $V_G = +2\text{V}$ . **Boldface** limits apply at the temperature extremes.

Symbol	Parameter	Conditions	Min <sup>(2)</sup>	Typ <sup>(2)</sup>	Max <sup>(2)</sup>	Units
<b>Frequency Domain Response</b>						
BW	-3dB Bandwidth	$V_{\text{OUT}} < 0.5\text{PP}$		130		MHz
		$V_{\text{OUT}} < 0.5\text{PP}$ , $A_{V(\text{MAX})} = 100$		50		
GF	Gain Flatness	$V_{\text{OUT}} < 0.5V_{\text{PP}}$ $0.6\text{V} \leq V_G \leq 2\text{V}$ , $\pm 0.3\text{dB}$		30		MHz
Att Range	Flat Band (Relative to Max Gain) Attenuation Range <sup>(3)</sup>	$\pm 0.2\text{dB}$ , $f < 30\text{MHz}$		16		dB
		$\pm 0.1\text{dB}$ , $f < 30\text{MHz}$		7.5		
BW Control	Gain control Bandwidth	$V_G = 1\text{V}^{(4)}$		100		MHz
PL	Linear Phase Deviation	DC to 60MHz		1.5		deg
G Delay	Group Delay	DC to 130MHz		2.5		ns
CT (dB)	Feed-through	$V_G = 0\text{V}$ , 30MHz (Output Referred)		-47		dB
GR	Gain Adjustment Range	$f < 10\text{MHz}$		72		dB
		$f < 30\text{MHz}$		67		
<b>Time Domain Response</b>						
$t_r$ , $t_f$	Rise and Fall Time	0.5V Step		2.2		ns
OS %	Overshoot	0.5V Step		10		%
SR	Slew Rate	4V Step		1800		V/ $\mu\text{s}$
$\Delta$ G Rate	Gain Change Rate	$V_{\text{IN}} = 0.3\text{V}$ , 10%-90% of Final Output		4.8		dB/ns
<b>Distortion &amp; Noise Performance</b>						
HD2	2 <sup>nd</sup> Harmonic Distortion	$2V_{\text{PP}}$ , 20MHz		-55		dBc
HD3	3 <sup>rd</sup> Harmonic Distortion	$2V_{\text{PP}}$ , 20MHz		-57		dBc
THD	Total Harmonic Distortion	$2V_{\text{PP}}$ , 20MHz		-53		dBc
En tot	Total Equivalent Input Noise	1MHz to 150MHz		7.7		nV/ $\sqrt{\text{Hz}}$
$I_N$	Input Noise Current	1MHz to 150MHz		2.4		pA/ $\sqrt{\text{Hz}}$
DG	Differential Gain	$f = 4.43\text{MHz}$ , $R_L = 150\Omega$ , Neg. Sync		0.34		%

- (1) Electrical Table values apply only for factory testing conditions at the temperature indicated. Factory testing conditions result in very limited self-heating of the device such that  $T_J = T_A$ . No assurance of parametric performance is indicated in the electrical tables under conditions of internal self-heating where  $T_J > T_A$ .
- (2) Typical values represent the most likely parametric norm. Bold numbers refer to over temperature limits.
- (3) Flat Band Attenuation (Relative to Max Gain) Range Definition: Specified as the attenuation range from maximum which allows gain flatness specified (either  $\pm 0.2\text{dB}$  or  $\pm 0.1\text{dB}$ ) relative to  $A_{V(\text{MAX})}$  gain. For example, for  $f < 30\text{MHz}$ , here are the Flat Band Attenuation ranges:  
 $\pm 0.2\text{dB}$  20dB down to 4dB = 16dB range  
 $\pm 0.1\text{dB}$  20dB down to 12.5 dB = 7.5dB range
- (4) Gain Control Frequency Response Schematic:

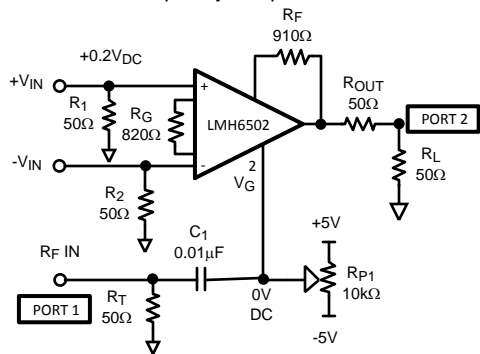

## Electrical Characteristics<sup>(1)</sup> (continued)

Unless otherwise specified, all limits specified for  $T_J = 25^\circ\text{C}$ ,  $V_S = \pm 5\text{V}$ ,  $A_{V(\text{MAX})} = 10$ ,  $V_{\text{CM}} = 0\text{V}$ ,  $R_F = 1\text{k}\Omega$ ,  $R_G = 174\Omega$ ,  $V_{\text{IN\_DIFF}} = \pm 0.1\text{V}$ ,  $R_L = 100\Omega$ ,  $V_G = +2\text{V}$ . **Boldface** limits apply at the temperature extremes.

Symbol	Parameter	Conditions	Min <sup>(2)</sup>	Typ <sup>(2)</sup>	Max <sup>(2)</sup>	Units
DP	Differential Phase	$f = 4.43\text{MHz}$ , $R_L = 150\Omega$ , Neg. Sync		0.10		deg
<b>DC &amp; Miscellaneous Performance</b>						
GACCU	Gain Accuracy (See <a href="#">Application Information</a> )	$V_G = 2.0\text{V}$		0.0	+0.6	dB
		$1\text{V} < V_G < 2\text{V}$		+0.6/-0.3	+3.1/-3.6	
G Match	Gain Matching (See <a href="#">Application Information</a> )	$V_G = 2.0\text{V}$		–	$\pm 0.6$	dB
		$1 < V_G < 2\text{V}$		–	+2.8/-3.9	
K	Gain Multiplier (See <a href="#">Application Information</a> )		1.61 <b>1.58</b>	1.72	1.84 <b>1.91</b>	V/V
$V_{\text{CM}}$	Input Voltage Range	Pin 3 & 6 Common Mode, $ \text{CMRR}  > 55\text{dB}^{(5)}$	$\pm 2.0$ <b><math>\pm 1.70</math></b>	$\pm 2.2$		V
$V_{\text{IN\_DIFF}}$	Differential Input Voltage	Between pins 3 & 6	$\pm 0.3$ <b><math>\pm 0.12</math></b>	$\pm 0.39$		V
$I_{\text{RG\_MAX}}$	$R_G$ Current	Pins 4 & 5	$\pm 1.70$ <b><math>\pm 1.56</math></b>	$\pm 2.22$		mA
$I_{\text{BIAS}}$	Bias Current	Pins 3 & 6 <sup>(6)</sup>		9	18 <b>20</b>	$\mu\text{A}$
		Pins 3 & 6 <sup>(6)</sup> , $V_S = \pm 2.5\text{V}$		2.5	5 <b>6</b>	
TC $I_{\text{BIAS}}$	Bias Current Drift	Pin 3 & 6 <sup>(7)</sup>		100		nA/ $^\circ\text{C}$
$I_{\text{OFF}}$	Offset Current	Pin 3 & 6		0.01	2.0 <b>3.6</b>	$\mu\text{A}$
TC $I_{\text{OFF}}$	Offset Current Drift	See <sup>(7)</sup>		5		nA/ $^\circ\text{C}$
$R_{\text{IN}}$	Input Resistance	Pin 3 & 6		750		k $\Omega$
$C_{\text{IN}}$	Input Capacitance	Pin 3 & 6		5		pF
$I_{\text{VG}}$	$V_G$ Bias Current	Pin 2, $V_G = 0\text{V}^{(6)}$		-300		$\mu\text{A}$
TC $I_{\text{VG}}$	$V_G$ Bias Drift	Pin 2 <sup>(7)</sup>		20		nA/ $^\circ\text{C}$
$R_{\text{VG}}$	$V_G$ Input Resistance	Pin 2		10		k $\Omega$
$C_{\text{VG}}$	$V_G$ Input Capacitance	Pin 2		1.3		pF
$V_{\text{OUT}}$	Output Voltage Range	$R_L = 100\Omega$	$\pm 3.00$ <b><math>\pm 2.95</math></b>	$\pm 3.20$		V
		$R_L = \text{Open}$	$\pm 3.95$ <b><math>\pm 3.82</math></b>	$\pm 4.00$		
$R_{\text{OUT}}$	Output Impedance	DC		0.1		$\Omega$
$I_{\text{OUT}}$	Output Current	$V_{\text{OUT}} = \pm 4\text{V}$ from Rails	$\pm 80$ <b><math>\pm 75</math></b>	$\pm 90$		mA
$V_{\text{O\_OFFSET}}$	Output Offset Voltage	$0\text{V} < V_G < 2\text{V}$		$\pm 80$	$\pm 300$ <b><math>\pm 380</math></b>	mV
+PSRR	+Power Supply Rejection Ratio <sup>(8)</sup>	Input Referred, 1V change, $V_G = 2.2\text{V}$		-69	-47 <b>-45</b>	dB
-PSRR	-Power Supply Rejection Ratio <sup>(8)</sup>	Input Referred, 1V change, $V_G = 2.2\text{V}$		-58	-41 <b>-40</b>	dB
CMRR	Common Mode Rejection Ratio <sup>(5)</sup>	Input Referred, $V_G = 2\text{V}$ $-1.8\text{V} < V_{\text{CM}} < 1.8\text{V}$		-72		dB
$I_S$	Supply Current	No Load		27	38 <b>41</b>	mA
		$V_S = \pm 2.5\text{V}$ , $R_L = \text{Open}$		9.3	16 <b>19</b>	

(5) CMRR definition:  $[\Delta V_{\text{OUT}}/\Delta V_{\text{CM}}] / A_V$  with 0.1V differential input voltage.

(6) Positive current corresponds to current flowing in the device.

(7) Drift determined by dividing the change in parameter distribution average at temperature extremes by the total temperature change.

(8) +PSRR definition:  $[\Delta V_{\text{OUT}}/\Delta V^+] / A_V$ , -PSRR definition:  $[\Delta V_{\text{OUT}}/\Delta V^-] / A_V$  with 0.1V differential input voltage.

### Connection Diagram

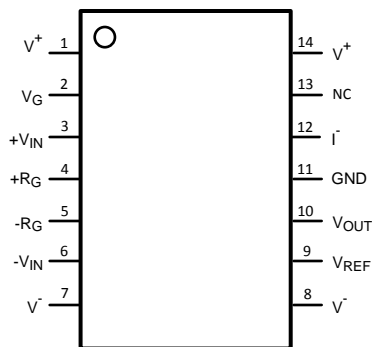

**14-Pin SOIC/TSSOP (Top View)**  
**See Package Numbers D (R-PDSO-G14) and PW (R-PDSO-G14)**

### Typical Performance Characteristics

Unless otherwise specified:  $V_S = \pm 5V$ ,  $25^\circ C$ ,  $V_G = V_{GMAX}$ ,  $V_{CM} = 0V$ ,  $R_F = 1k\Omega$ ,  $R_G = 174\Omega$ , both inputs terminated in  $50\Omega$ ,  $R_L = 100\Omega$ , Typical values, results referred to device output.

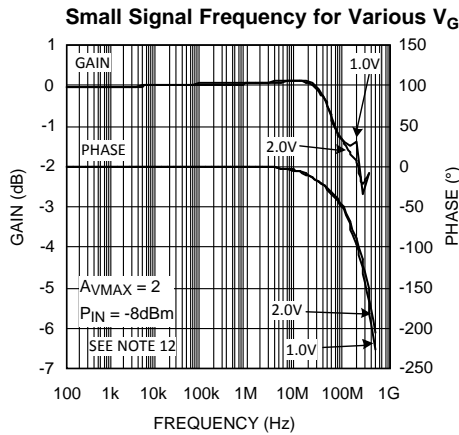

Figure 3.

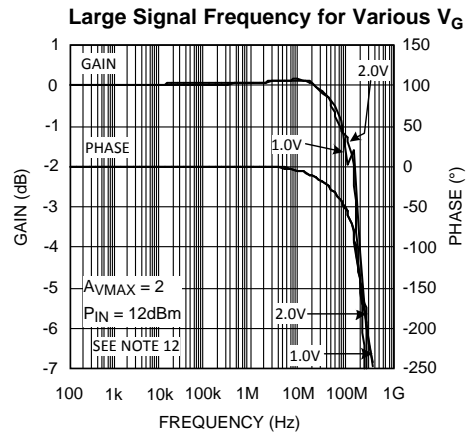

Figure 4.

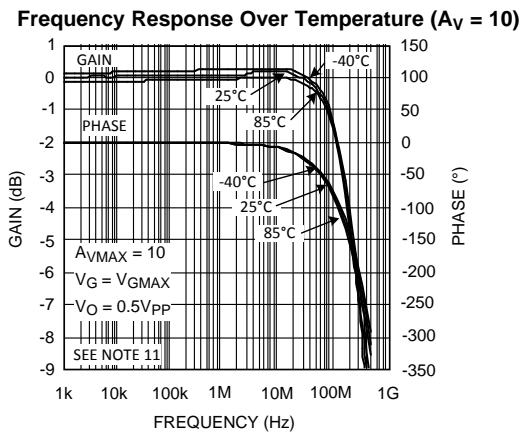

Figure 5.

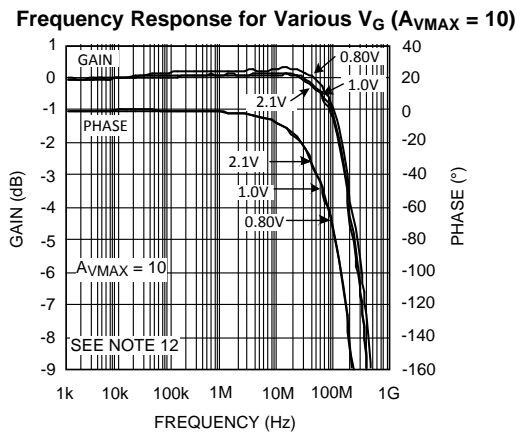

Figure 6.

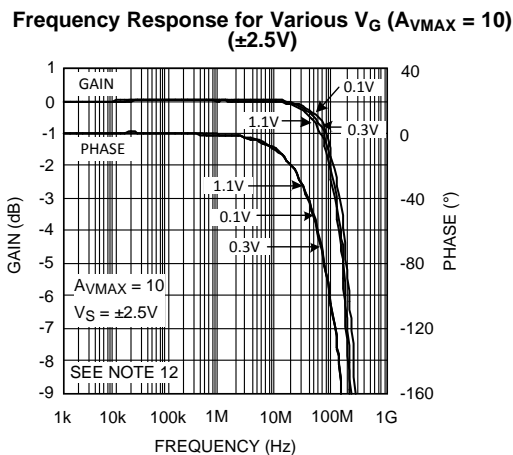

Figure 7.

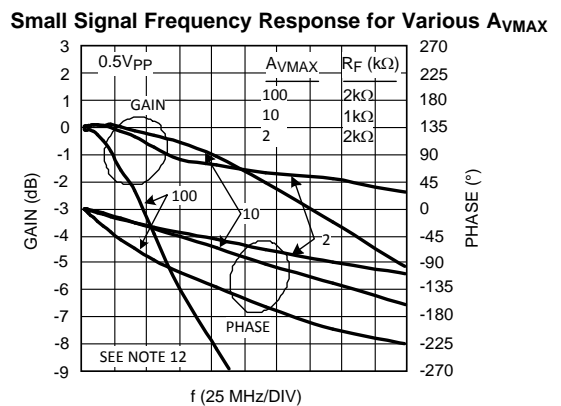

Figure 8.

### Typical Performance Characteristics (continued)

Unless otherwise specified:  $V_S = \pm 5V$ ,  $25^\circ C$ ,  $V_G = V_{GMAX}$ ,  $V_{CM} = 0V$ ,  $R_F = 1k\Omega$ ,  $R_G = 174\Omega$ , both inputs terminated in  $50\Omega$ ,  $R_L = 100\Omega$ , Typical values, results referred to device output.

Large Signal Frequency Response for Various  $A_{VMAX}$

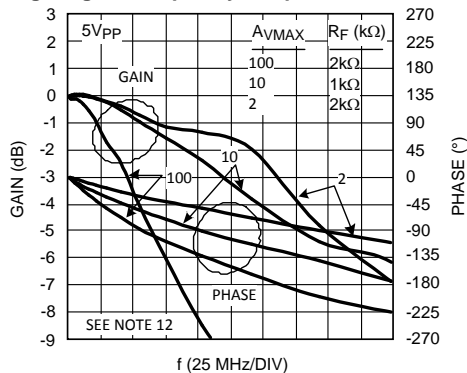

Figure 9.

Frequency Response for Various  $V_G$  ( $A_{VMAX} = 105$ ) (Small Signal)

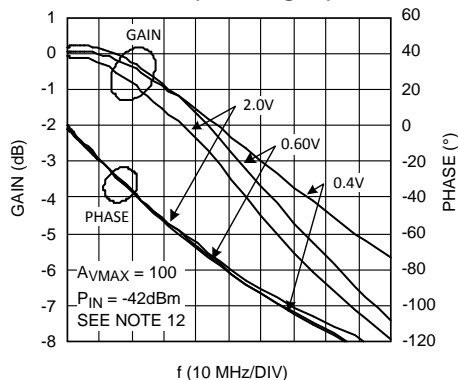

Figure 10.

Frequency Response for Various  $V_G$  ( $A_{VMAX} = 105$ ) (Large Signal)

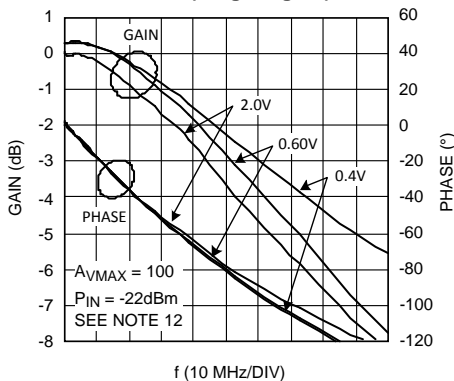

Figure 11.

$I_S$  vs.  $V_S$

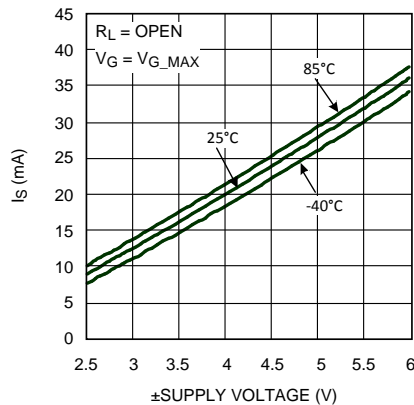

Figure 12.

$I_S$  vs.  $V_S$

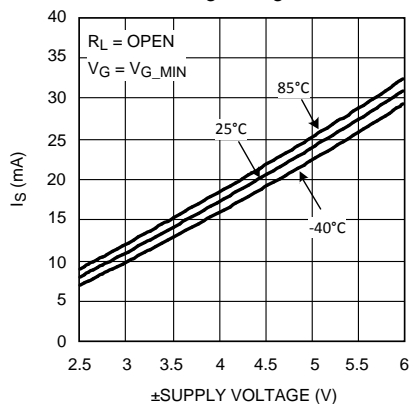

Figure 13.

Input Bias Current vs.  $V_S$

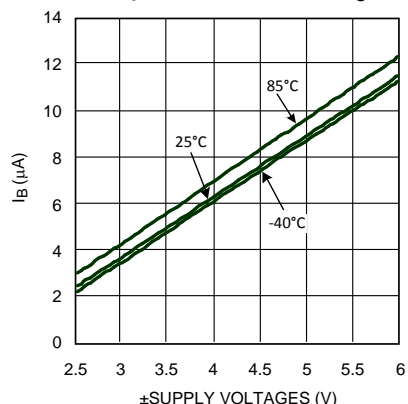

Figure 14.

**Typical Performance Characteristics (continued)**

Unless otherwise specified:  $V_S = \pm 5V$ ,  $25^\circ C$ ,  $V_G = V_{GMAX}$ ,  $V_{CM} = 0V$ ,  $R_F = 1k\Omega$ ,  $R_G = 174\Omega$ , both inputs terminated in  $50\Omega$ ,  $R_L = 100\Omega$ , Typical values, results referred to device output.

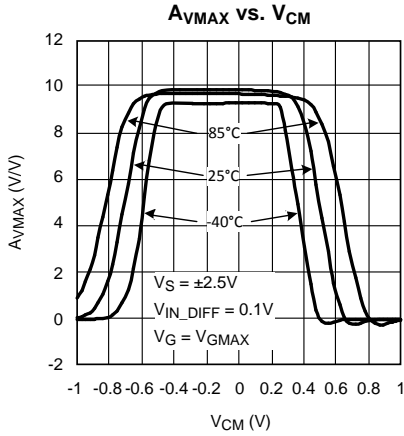

Figure 15.

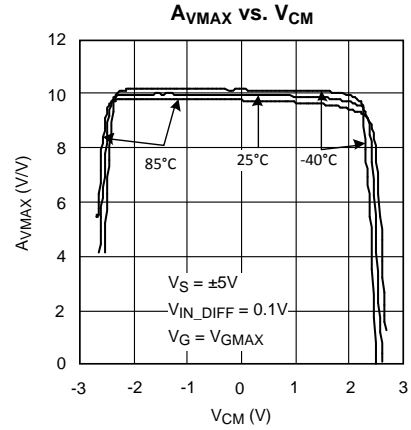

Figure 16.

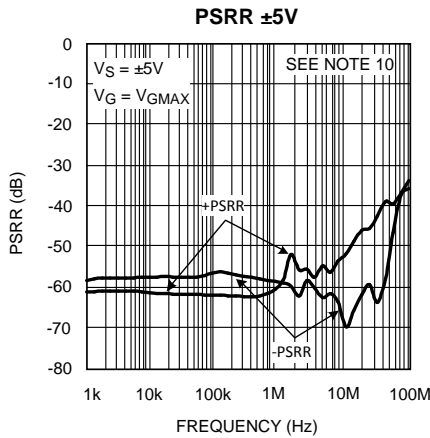

Figure 17.

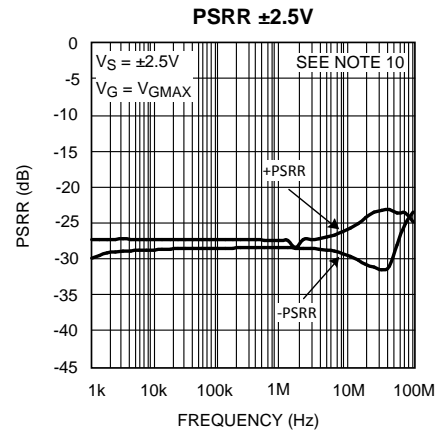

Figure 18.

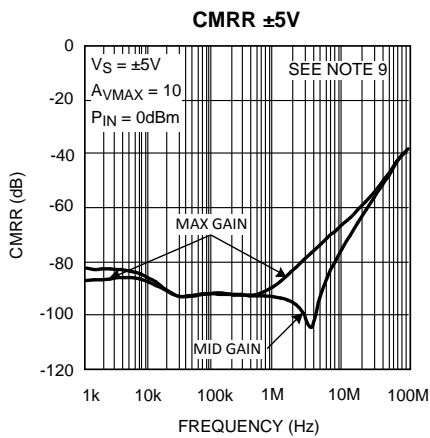

Figure 19.

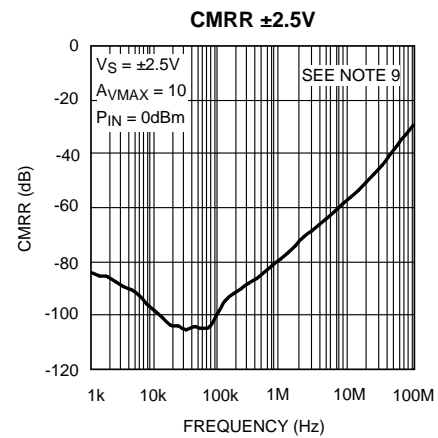

Figure 20.



Typical Performance Characteristics (continued)

Unless otherwise specified:  $V_S = \pm 5V$ ,  $25^\circ C$ ,  $V_G = V_{GMAX}$ ,  $V_{CM} = 0V$ ,  $R_F = 1k\Omega$ ,  $R_G = 174\Omega$ , both inputs terminated in  $50\Omega$ ,  $R_L = 100\Omega$ , Typical values, results referred to device output.

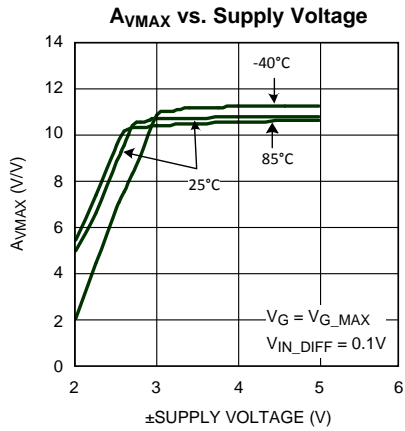

Figure 21.

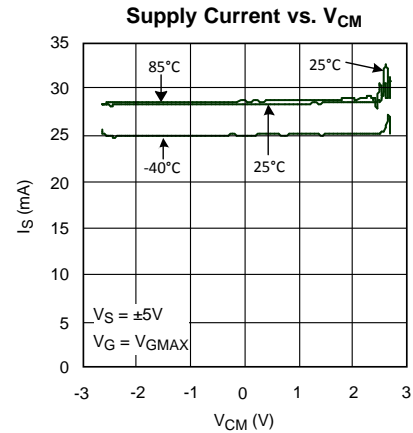

Figure 22.

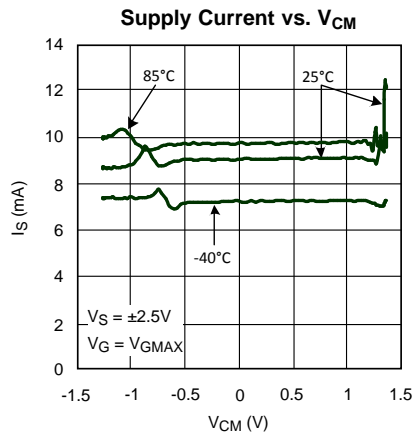

Figure 23.

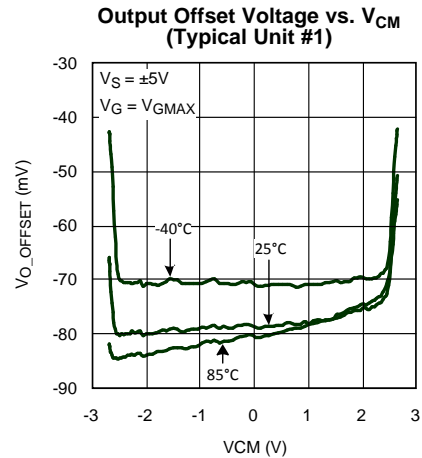

Figure 24.

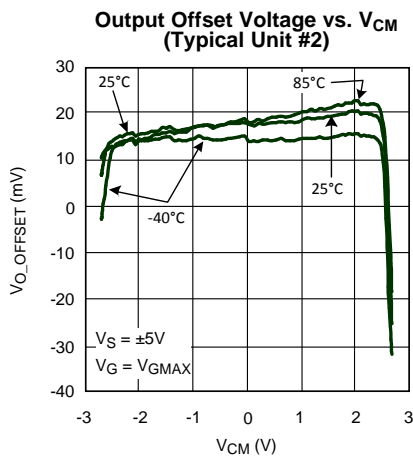

Figure 25.

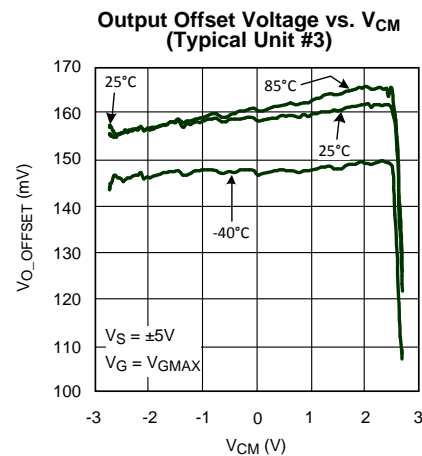

Figure 26.

**Typical Performance Characteristics (continued)**

Unless otherwise specified:  $V_S = \pm 5V$ ,  $25^\circ C$ ,  $V_G = V_{GMAX}$ ,  $V_{CM} = 0V$ ,  $R_F = 1k\Omega$ ,  $R_G = 174\Omega$ , both inputs terminated in  $50\Omega$ ,  $R_L = 100\Omega$ , Typical values, results referred to device output.

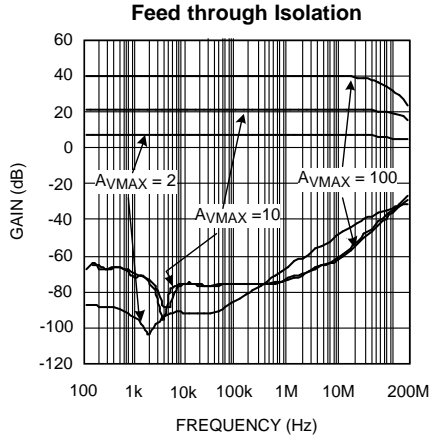

Figure 27.

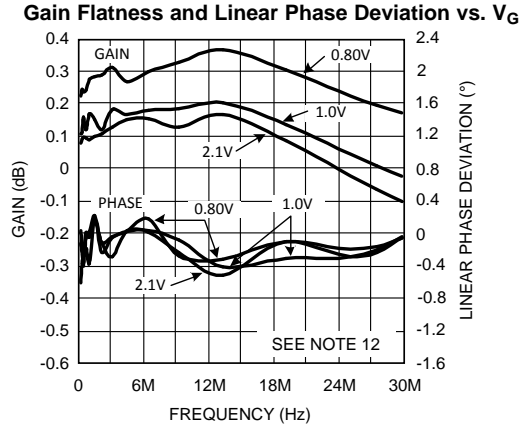

Figure 28.

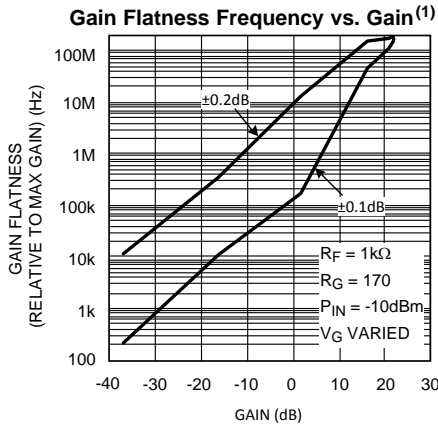

Figure 29.

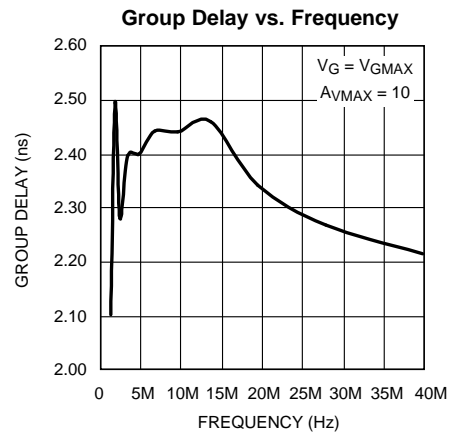

Figure 30.

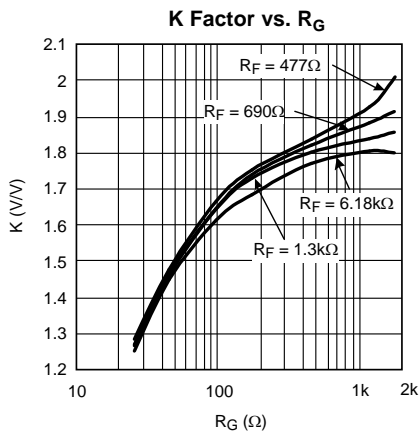

Figure 31.

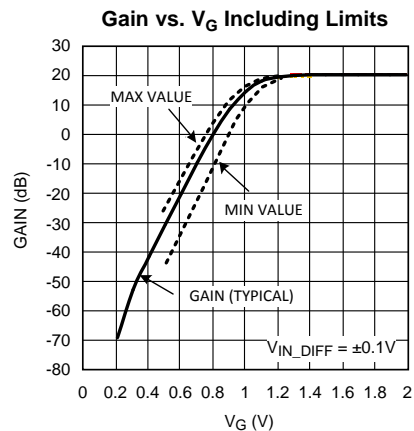

Figure 32.

(1) Flat Band Attenuation (Relative to Max Gain) Range Definition: Specified as the attenuation range from maximum which allows gain flatness specified (either  $\pm 0.2dB$  or  $\pm 0.1dB$ ) relative to  $A_{VMAX}$  gain. For example, for  $f < 30MHz$ , here are the Flat Band Attenuation ranges:  
 $\pm 0.2dB$  20dB down to 4dB = 16dB range  
 $\pm 0.1dB$  20dB down to 12.5 dB = 7.5dB range

**Typical Performance Characteristics (continued)**

Unless otherwise specified:  $V_S = \pm 5V$ ,  $25^\circ C$ ,  $V_G = V_{GMAX}$ ,  $V_{CM} = 0V$ ,  $R_F = 1k\Omega$ ,  $R_G = 174\Omega$ , both inputs terminated in  $50\Omega$ ,  $R_L = 100\Omega$ , Typical values, results referred to device output.

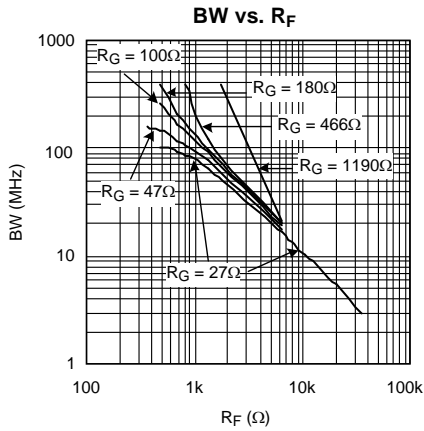

Figure 33.

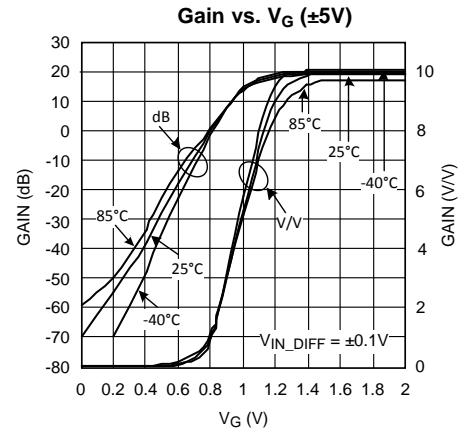

Figure 34.

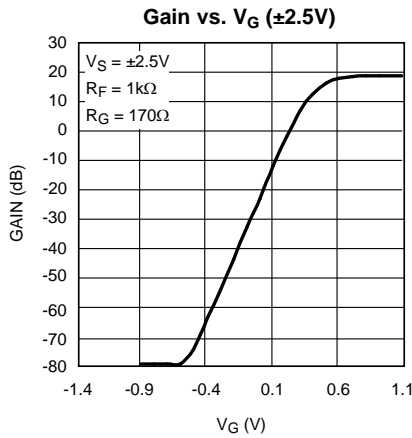

Figure 35.

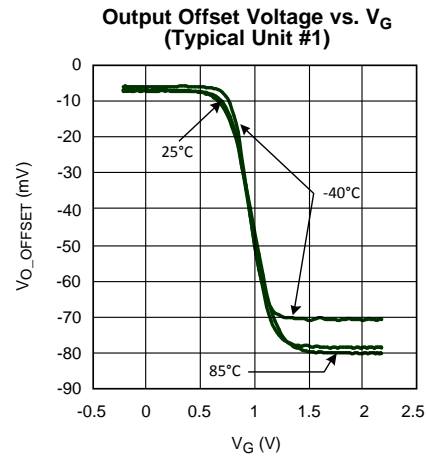

Figure 36.

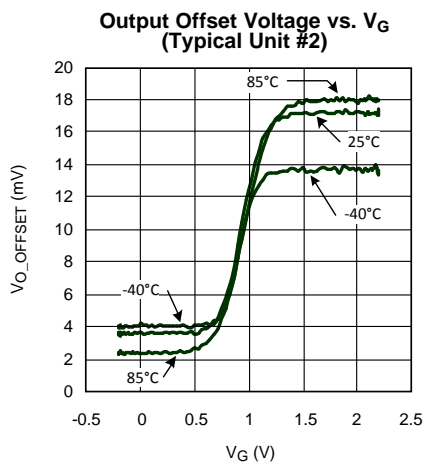

Figure 37.

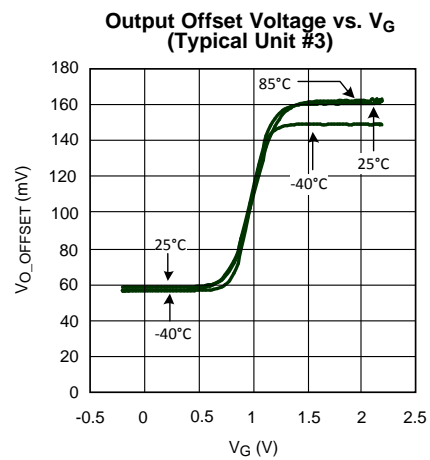

Figure 38.

**Typical Performance Characteristics (continued)**

Unless otherwise specified:  $V_S = \pm 5V$ ,  $25^\circ C$ ,  $V_G = V_{GMAX}$ ,  $V_{CM} = 0V$ ,  $R_F = 1k\Omega$ ,  $R_G = 174\Omega$ , both inputs terminated in  $50\Omega$ ,  $R_L = 100\Omega$ , Typical values, results referred to device output.

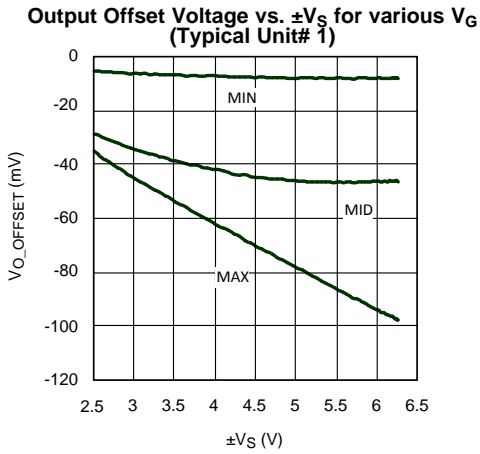

Figure 39.

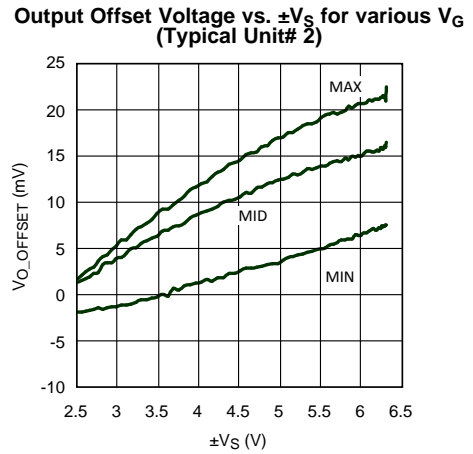

Figure 40.

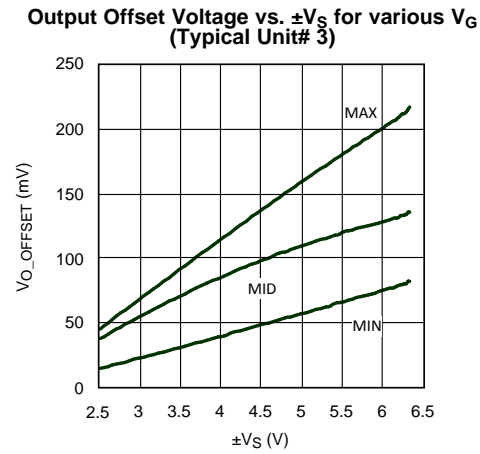

Figure 41.

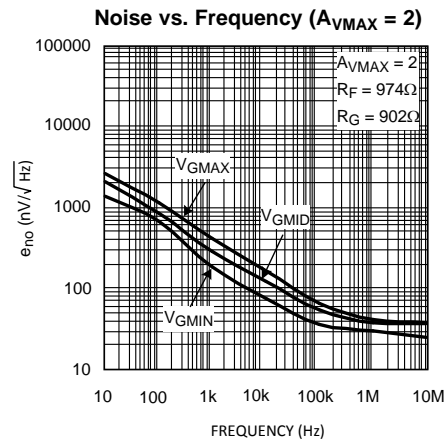

Figure 42.

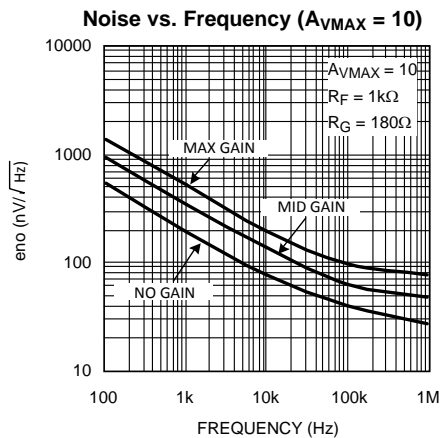

Figure 43.

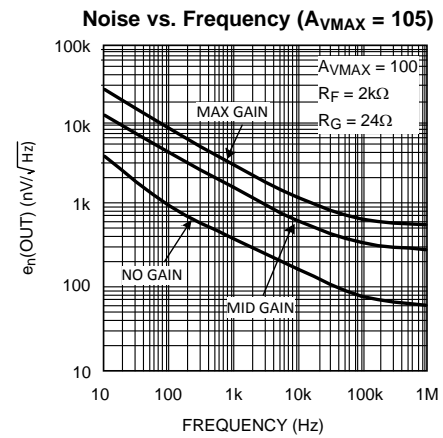

Figure 44.

Typical Performance Characteristics (continued)

Unless otherwise specified:  $V_S = \pm 5V$ ,  $25^\circ C$ ,  $V_G = V_{GMAX}$ ,  $V_{CM} = 0V$ ,  $R_F = 1k\Omega$ ,  $R_G = 174\Omega$ , both inputs terminated in  $50\Omega$ ,  $R_L = 100\Omega$ , Typical values, results referred to device output.

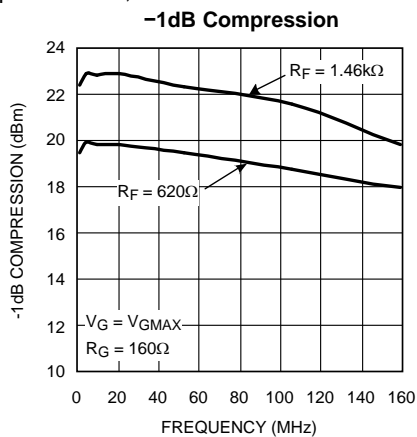

Figure 45.

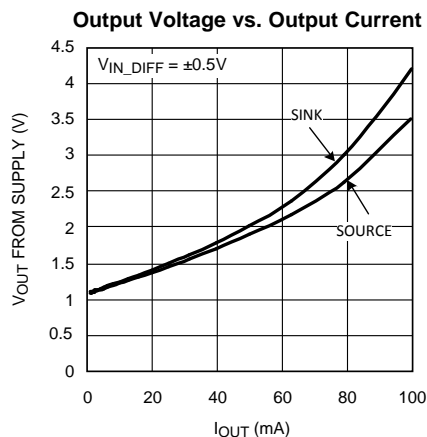

Figure 46.

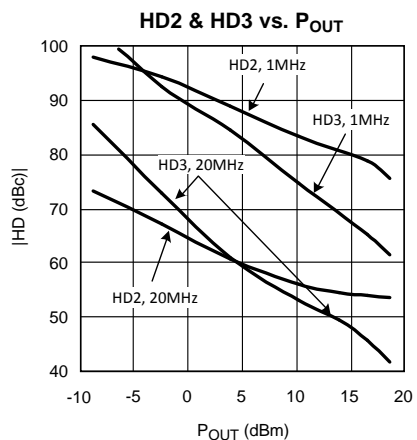

Figure 47.

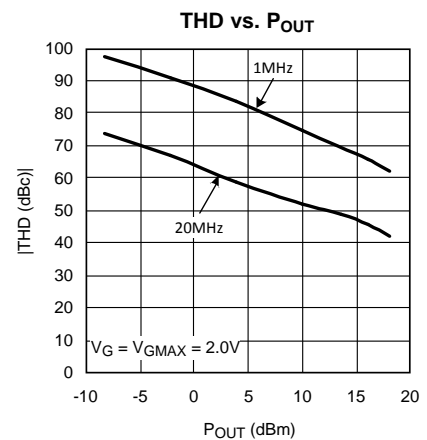

Figure 48.

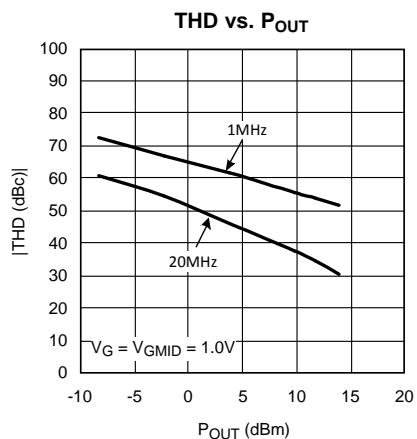

Figure 49.

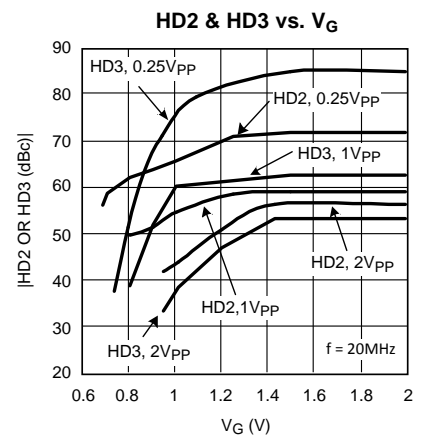

Figure 50.

**Typical Performance Characteristics (continued)**

Unless otherwise specified:  $V_S = \pm 5V$ ,  $25^\circ C$ ,  $V_G = V_{GMAX}$ ,  $V_{CM} = 0V$ ,  $R_F = 1k\Omega$ ,  $R_G = 174\Omega$ , both inputs terminated in  $50\Omega$ ,  $R_L = 100\Omega$ , Typical values, results referred to device output.

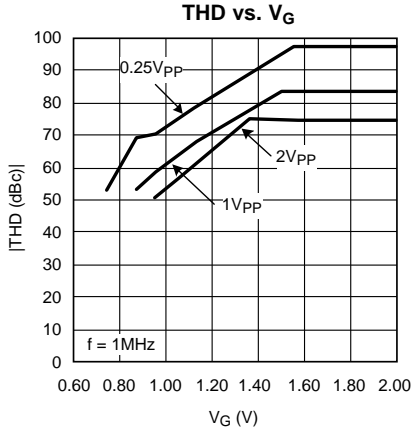

Figure 51.

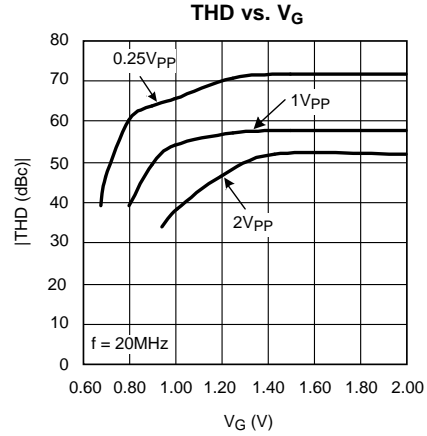

Figure 52.

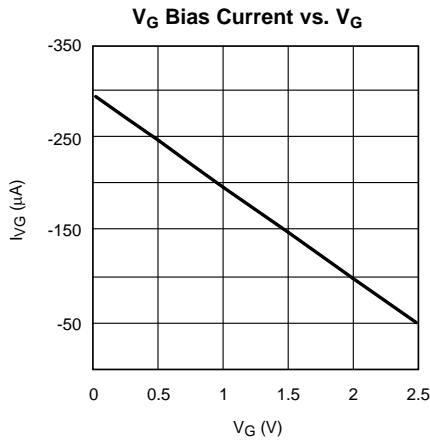

Figure 53.

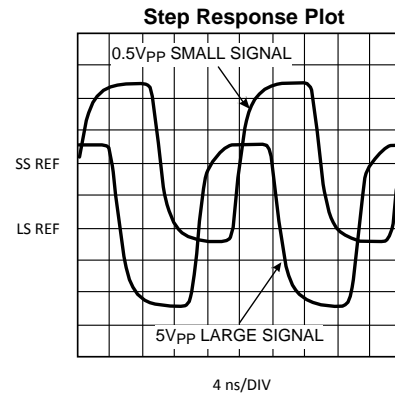

Figure 54.

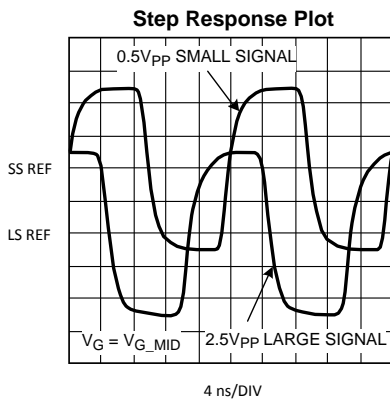

Figure 55.

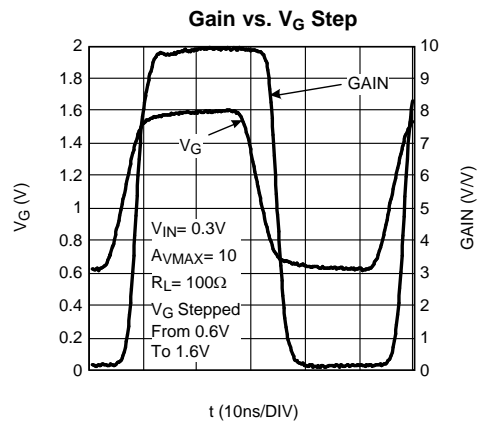
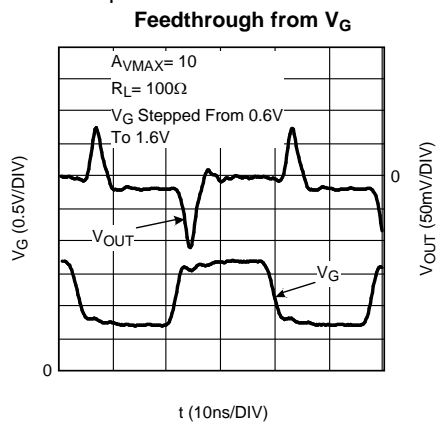

Figure 56.

**Typical Performance Characteristics (continued)**

Unless otherwise specified:  $V_S = \pm 5V$ ,  $25^\circ C$ ,  $V_G = V_{GMAX}$ ,  $V_{CM} = 0V$ ,  $R_F = 1k\Omega$ ,  $R_G = 174\Omega$ , both inputs terminated in  $50\Omega$ ,  $R_L = 100\Omega$ , Typical values, results referred to device output.



**Figure 57.**

## APPLICATION INFORMATION

### THEORY OF OPERATION

A simplified schematic is shown in Figure 58.  $+V_{IN}$  and  $-V_{IN}$  are buffered with closed loop voltage followers inducing a signal current in  $R_g$  proportional to  $(+V_{IN}) - (-V_{IN})$ , the differential input voltage. This current controls a current source which supplies two well-matched transistor, Q1 and Q2.

The current flowing through Q2 is converted to the final output voltage using  $R_F$  and the output amplifier, U1. By changing the fraction of the signal current "I" which flows through Q2, the gain is changed. This is done by changing the voltage applied differentially to the bases of Q1 and Q2. For example, with  $V_G = 0V$ , Q1 conducts heavily and Q2 is off. With none of "I" flowing through  $R_F$ , the LMH6502's input to output gain is strongly attenuated. With  $V_G = +2V$ , Q1 is off and the entire signal current flows through Q2 to  $R_F$  producing maximum gain. With  $V_G$  set to 1V, the bases of Q1 and Q2 are set to approximately the same voltage, Q1 and Q2 have the same collector currents - equal to one half of the signal current "I", thus the gain is approximately one half the maximum gain.

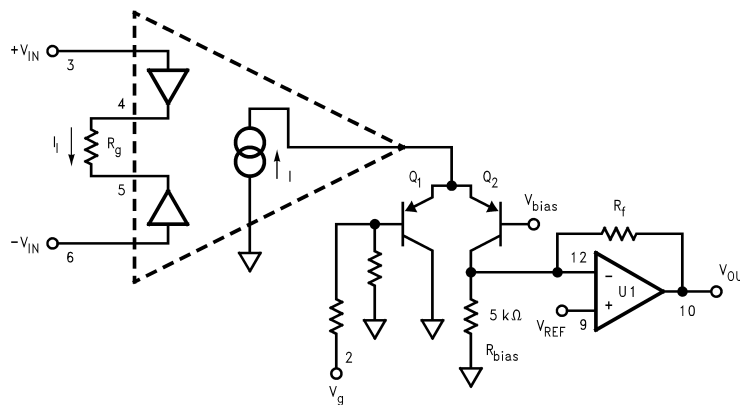

Figure 58. LMH6502 Block Diagram

### CHOOSING $R_F$ & $R_G$

Maximum input amplitude and maximum gain are the two key specifications that determine component values in a LMH6502 application.

The output stage op amp is a current-feedback type amplifier optimized for  $R_F = 1k\Omega$ .  $R_G$  can then be computed as:

$$R_G = \frac{R_F \times 1.72}{A_{V_{MAX}}} - 3\Omega \text{ WITH } R_F = 1K\Omega \quad (1)$$

To determine whether the maximum input amplitude will overdrive the LMH6502, compute:

$$V_{D_{MAX}} = (R_G + 3.0\Omega) \times 1.70\text{mA} \quad (2)$$

the maximum differential input voltage for linear operation. If the maximum input amplitude exceeds the above  $V_{D_{MAX}}$  limit, then LMH6502 should either be moved to a location in the signal chain where input amplitudes are reduced, or the LMH6502 gain  $A_{V_{MAX}}$  should be reduced or the values for  $R_G$  and  $R_F$  should be increased. The overall system performance impact is different based on the choice made. If the input amplitude is reduced, recompute the impact on signal-to-noise ratio. If  $A_{V_{MAX}}$  is reduced, post LMH6502 amplifier gain, should be increased, or another gain stage added to make up for reduced system gain. To increase  $R_G$  and  $R_F$ , compute the lowest acceptable value for  $R_G$ :

$$R_G > 590 \times V_{D_{MAX}} - 3\Omega \quad (3)$$

Operating with  $R_G$  larger than this value insures linear operation of the input buffers.

$R_F$  may be computed from selected  $R_G$  and  $A_{V_{MAX}}$ :  $R_F$  should be  $\geq 1k\Omega$  for overall best performance, however  $R_F < 1k\Omega$  can be implemented if necessary using a loop gain reducing resistor to ground on the inverting summing node of the output amplifier (see application note OA-13 (SNOA366) for details).



## ADJUSTING OFFSET

Offset can be broken into two parts; an input-referred term and an output-referred term. The input-referred offset shows up as a variation in output voltage as  $V_G$  is changed. This can be trimmed using the circuit in Figure 59 by placing a low frequency square wave ( $V_{LOW} = 0V$ ,  $V_{HIGH} = 2V$  into  $V_G$  with  $V_{IN} = 0V$ , the input referred  $V_{OS}$  term shows up as a small square wave riding a DC value. Adjust  $R_{10}$  to null the  $V_{OS}$  square wave term to zero. After adjusting the input-referred offset, adjust  $R_{14}$  (with  $V_{IN} = 0$ ,  $V_G = 0$ ) until  $V_{OUT}$  is zero. Finally, for inverting applications  $V_{IN}$  may be applied to pin 6 and the offset adjustment to pin 3. These steps will minimize the output offset voltage. However, since the offset term itself varies with the gain setting, the correction is not perfect and some residual output offset will remain at in-between  $V_G$ 's. Also, this offset trim does not improve output offset temperature coefficient.

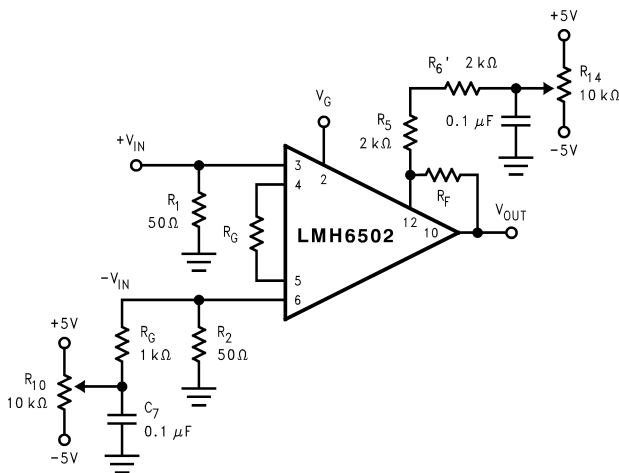

Figure 59. Nulling the output offset voltage

## GAIN ACCURACY

Defined as the actual gain compared against the theoretical gain at a certain  $V_G$  (results expressed in dB).

Theoretical gain is given by:

$$A(V/V) = K \times \frac{R_F}{R_G} \times \frac{1}{1 + e^{\left[ \frac{1 - V_G}{V_C} \right]}} \quad (4)$$

Where  $K = 1.72$  (nominal) &  $V_C = 90mV$  @ room temperature.

For a  $V_G$  range, the value specified in the tables represents the worst case accuracy over the entire range. The "Typical" value would be the worst case difference between the "Typical Gain" and the "Theoretical gain". The "Max" value would be the worst case difference between the max/min gain limit and the "Theoretical gain".

## GAIN MATCHING

Defined as the limit on gain variation at a certain  $V_G$  (expressed in dB). Specified as "Max" only (no "Typical"). For a  $V_G$  range, the value specified represents the worst case matching over the entire range. The "Max" value would be the worst case difference between the max/min gain limit and the typical gain.

## NOISE

Figure 60 describes the LMH6502's output-referred spot noise density as a function of frequency with  $A_{VMAX} = 10V/V$ . The plot includes all the noise contributing terms. However, with both inputs terminated in  $50\Omega$ , the input noise contribution is minimal. At  $A_{VMAX} = 10V/V$ , the LMH6502 has a typical input-referred spot noise density ( $e_{in}$ ) of  $7.7nV/\sqrt{Hz}$  flat-band. For applications extending well into the flat-band region, the input RMS voltage noise can be determined from the following single-pole model:

$$V_{\text{RMS}} = e_{\text{in}} * \sqrt{1.57 * (-3\text{dB BANDWIDTH})}$$

(5)

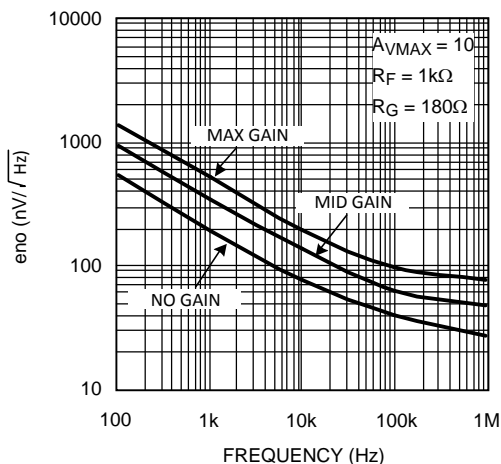

**Figure 60. Output Referred Voltage Noise vs. Frequency**

## CIRCUIT LAYOUT CONSIDERATIONS & EVALUATION BOARD

A good high frequency PCB layout including ground plane construction and power supply bypassing close to the package are critical to achieving full performance. The amplifier is sensitive to stray capacitance to ground at the  $\Gamma$  input (pin 12); keep node trace area small. Shunt capacitance across the feedback resistor should not be used to compensate for this effect. For best performance at low maximum gains ( $A_{\text{VMAX}} < 10$ )  $+R_G$  and  $-R_G$  connections should be treated in a similar fashion. Capacitance to ground should be minimized by removing the ground plane from under the body of  $R_G$ . Parasitic or load capacitance directly on the output (pin 10) degrades phase margin leading to frequency response peaking.

The LMH6502 is fully stable when driving a 100 $\Omega$  load. With reduced load (e.g. 1k $\Omega$ ) there is a possibility of instability at very high frequencies beyond 400MHz especially with a capacitive load. When the LMH6502 is connected to a light load as such, it is recommended to add a snubber network to the output (e.g. 100 $\Omega$  and 39pF in series tied between the LMH6502 output and ground).  $C_L$  can also be isolated from the output by placing a small resistor in series with the output (pin 10).

Component parasitics also influence high frequency results. Therefore it is recommended to use metal film resistors such as RN55D or leadless components such as surface mount devices. High profile sockets are not recommended.

Texas Instruments suggests the following evaluation boards as a guide for high frequency layout and as an aid in device testing and characterization:

Device	Package	Evaluation Board Part Number
LMH6502MA	SOIC	LMH730033

## SINGLE SUPPLY OPERATION

It is possible to operate the LMH6502 with a single supply. To do so, tie pin 11 (GND) to a potential about mid point between  $V^+$  and  $V^-$ . Two examples are shown in [Figure 61](#) & [Figure 62](#).

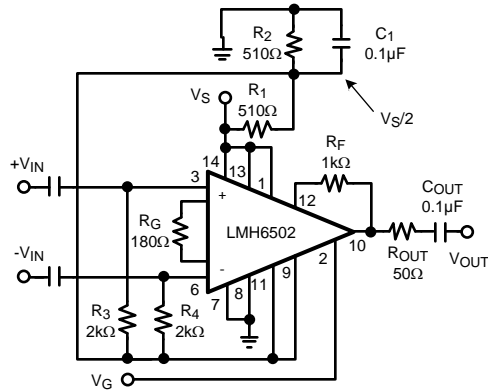

Figure 61. AC Coupled Single Supply VGA

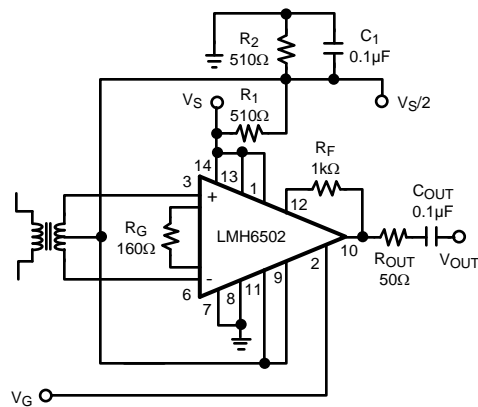

Figure 62. Transformer Coupled Single Supply VGA

## OPERATING AT LOWER SUPPLY VOLTAGES

The LMH6502 is rated for operation down to 5V supplies ( $V^+$  - $V^-$ ). There are some specifications shown for operation at  $\pm 2.5V$  within the data sheet (i.e. Frequency Response, CMRR, PSRR, Gain vs.  $V_G$ , etc.). Compared to  $\pm 5V$  operation, at lower supplies:

- a)  $V_G$  range shifts lower.  
Here are the approximate expressions for various  $V_G$  voltages as a function of  $V^+$ :

**Table 1.  $V_G$  Definition Based on  $V^+$**

$V_G$	Definition	Expression (V)
$V_{G\_MIN}$	Gain Cut-off	$0.2 \times V^+ - 1$
$V_{G\_MID}$	$A_{VMAX}/2$	$0.2 \times V^+$
$V_{G\_MAX}$	$A_{VMAX}$	$0.2 \times V^+ + 1$

- b)  $V_{G\_LIMIT}$  (maximum permissible voltage on  $V_G$ ) is reduced. This is due to limitations within the device arising from transistor headroom. Beyond this limit, device performance will be affected (non-destructive). This could reveal itself as premature high frequency response roll-off. With  $\pm 2.5V$  supplies,  $V_{G\_LIMIT}$  is below 1.1V whereas  $V_G = 1.5V$  is needed to get maximum gain. This means that operating under these conditions has reduced the maximum permissible voltage on  $V_G$  to a level below what is needed to get Max gain. If supply voltages are asymmetrical with  $V^+$  being lower, further "pinching" of  $V_G$  range could result; for example, with  $V^+ = 2V$ , and  $V^- = -3V$ ,  $V_{G\_LIMIT} = 0.40V$  which results in maximum gain being 2.5dB less than what would be expected when  $V_S$  is higher.
- c) "Max\_gain" reduces. There is an intrinsic reduction in max gain when the total supply voltage is reduced (see Typical Performance Characteristics plots for Gain vs.  $V_G$  ( $V_S = \pm 2.5V$ )). In addition, there is the more drastic mechanism described in "b" above. Beyond  $V_{G\_LIMIT}$ , high frequency response is also effected.

## Application Circuits

### AGC LOOP

Figure 63 shows a typical AGC circuit. The LMH6502 is followed up with a LMH6714 for higher overall gain. The output of the LMH6714 is rectified and fed to an inverting integrator using a LMH6657 (wideband voltage feedback op amp). When the output voltage,  $V_{OUT}$ , is too large the integrator output voltage ramps down reducing the net gain of the LMH6502 and  $V_{OUT}$ . If the output voltage is too small, the integrator ramps up increasing the net gain and the output voltage. Actual output level is set with  $R_1$ . To prevent shifts in DC output voltage with DC changes in input signal level, trim pot  $R_2$  is provided. AGC circuits are always limited in the range of input signals over which constant output level can be maintained. In this circuit, we would expect that reasonable AGC action could be maintained for at least 40dB. In practice, rectifier dynamic range limits reduce this slightly.

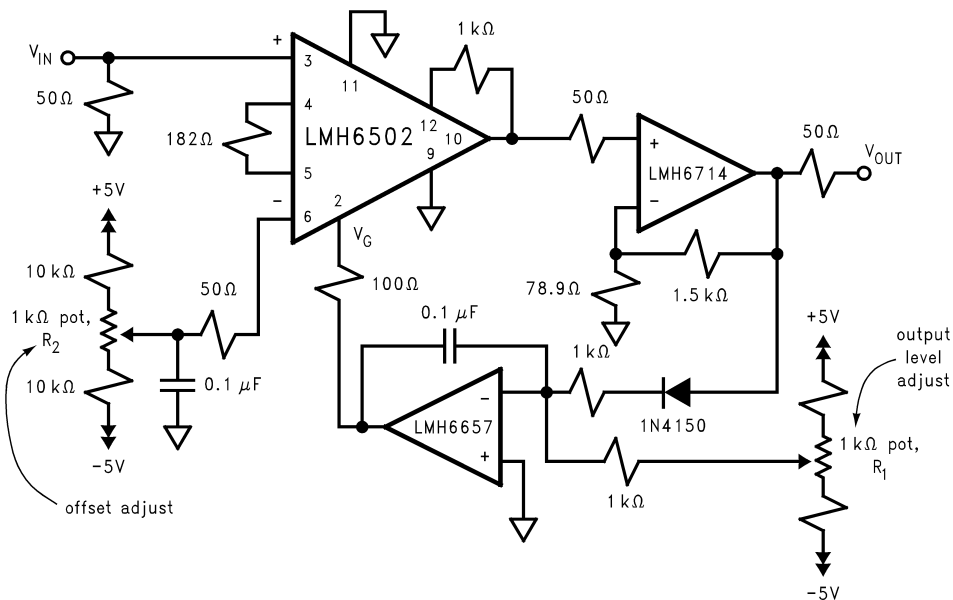

Figure 63. Automatic Gain Control (AGC) Loop

## FREQUENCY SHAPING

Frequency Shaping Frequency shaping and bandwidth extension of the LMH6502 can be accomplished using parallel networks connected across the  $R_G$  ports. The network shown in the Figure 64 schematic will effectively extend the LMH6502's bandwidth.

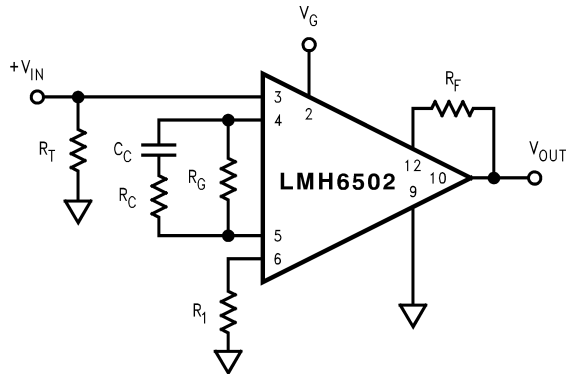

Figure 64. Frequency Shaping

## REVISION HISTORY

Changes from Revision C (March 2013) to Revision D	Page
• Changed layout of National Data Sheet to TI format .....	<a href="#">21</a>

**PACKAGING INFORMATION**

Orderable Device	Status (1)	Package Type	Package Drawing	Pins	Package Qty	Eco Plan (2)	Lead/Ball Finish	MSL Peak Temp (3)	Op Temp (°C)	Top-Side Markings (4)	Samples
LMH6502MA	ACTIVE	SOIC	D	14	55	TBD	Call TI	Call TI	-40 to 85	LMH6502MA	<a href="#">Samples</a>
LMH6502MA/NOPB	ACTIVE	SOIC	D	14	55	Green (RoHS & no Sb/Br)	CU SN	Level-1-260C-UNLIM	-40 to 85	LMH6502MA	<a href="#">Samples</a>
LMH6502MAX	ACTIVE	SOIC	D	14	2500	TBD	Call TI	Call TI	-40 to 85	LMH6502MA	<a href="#">Samples</a>
LMH6502MAX/NOPB	ACTIVE	SOIC	D	14	2500	Green (RoHS & no Sb/Br)	CU SN	Level-1-260C-UNLIM	-40 to 85	LMH6502MA	<a href="#">Samples</a>
LMH6502MT	ACTIVE	TSSOP	PW	14	94	TBD	Call TI	Call TI	-40 to 85	LMH6502MT	<a href="#">Samples</a>
LMH6502MT/NOPB	ACTIVE	TSSOP	PW	14	94	Green (RoHS & no Sb/Br)	CU SN	Level-1-260C-UNLIM	-40 to 85	LMH6502MT	<a href="#">Samples</a>
LMH6502MTX	ACTIVE	TSSOP	PW	14	2500	TBD	Call TI	Call TI	-40 to 85	LMH6502MTX	<a href="#">Samples</a>
LMH6502MTX/NOPB	ACTIVE	TSSOP	PW	14	2500	Green (RoHS & no Sb/Br)	CU SN	Level-1-260C-UNLIM	-40 to 85	LMH6502MTX	<a href="#">Samples</a>

(1) The marketing status values are defined as follows:

**ACTIVE:** Product device recommended for new designs.

**LIFEBUY:** TI has announced that the device will be discontinued, and a lifetime-buy period is in effect.

**NRND:** Not recommended for new designs. Device is in production to support existing customers, but TI does not recommend using this part in a new design.

**PREVIEW:** Device has been announced but is not in production. Samples may or may not be available.

**OBsolete:** TI has discontinued the production of the device.

(2) Eco Plan - The planned eco-friendly classification: Pb-Free (RoHS), Pb-Free (RoHS Exempt), or Green (RoHS & no Sb/Br) - please check <http://www.ti.com/productcontent> for the latest availability information and additional product content details.

**TBD:** The Pb-Free/Green conversion plan has not been defined.

**Pb-Free (RoHS):** TI's terms "Lead-Free" or "Pb-Free" mean semiconductor products that are compatible with the current RoHS requirements for all 6 substances, including the requirement that lead not exceed 0.1% by weight in homogeneous materials. Where designed to be soldered at high temperatures, TI Pb-Free products are suitable for use in specified lead-free processes.

**Pb-Free (RoHS Exempt):** This component has a RoHS exemption for either 1) lead-based flip-chip solder bumps used between the die and package, or 2) lead-based die adhesive used between the die and leadframe. The component is otherwise considered Pb-Free (RoHS compatible) as defined above.

**Green (RoHS & no Sb/Br):** TI defines "Green" to mean Pb-Free (RoHS compatible), and free of Bromine (Br) and Antimony (Sb) based flame retardants (Br or Sb do not exceed 0.1% by weight in homogeneous material)

(3) MSL, Peak Temp. -- The Moisture Sensitivity Level rating according to the JEDEC industry standard classifications, and peak solder temperature.

<sup>(4)</sup> Multiple Top-Side Markings will be inside parentheses. Only one Top-Side Marking contained in parentheses and separated by a "~" will appear on a device. If a line is indented then it is a continuation of the previous line and the two combined represent the entire Top-Side Marking for that device.

**Important Information and Disclaimer:** The information provided on this page represents TI's knowledge and belief as of the date that it is provided. TI bases its knowledge and belief on information provided by third parties, and makes no representation or warranty as to the accuracy of such information. Efforts are underway to better integrate information from third parties. TI has taken and continues to take reasonable steps to provide representative and accurate information but may not have conducted destructive testing or chemical analysis on incoming materials and chemicals. TI and TI suppliers consider certain information to be proprietary, and thus CAS numbers and other limited information may not be available for release.

In no event shall TI's liability arising out of such information exceed the total purchase price of the TI part(s) at issue in this document sold by TI to Customer on an annual basis.



**TAPE AND REEL INFORMATION**

**QUADRANT ASSIGNMENTS FOR PIN 1 ORIENTATION IN TAPE**

\*All dimensions are nominal

Device	Package Type	Package Drawing	Pins	SPQ	Reel Diameter (mm)	Reel Width W1 (mm)	A0 (mm)	B0 (mm)	K0 (mm)	P1 (mm)	W (mm)	Pin1 Quadrant
LMH6502MAX	SOIC	D	14	2500	330.0	16.4	6.5	9.35	2.3	8.0	16.0	Q1
LMH6502MAX/NOPB	SOIC	D	14	2500	330.0	16.4	6.5	9.35	2.3	8.0	16.0	Q1
LMH6502MTX	TSSOP	PW	14	2500	330.0	12.4	6.95	8.3	1.6	8.0	12.0	Q1
LMH6502MTX/NOPB	TSSOP	PW	14	2500	330.0	12.4	6.95	8.3	1.6	8.0	12.0	Q1

**TAPE AND REEL BOX DIMENSIONS**

\*All dimensions are nominal

Device	Package Type	Package Drawing	Pins	SPQ	Length (mm)	Width (mm)	Height (mm)
LMH6502MAX	SOIC	D	14	2500	367.0	367.0	35.0
LMH6502MAX/NOPB	SOIC	D	14	2500	367.0	367.0	35.0
LMH6502MTX	TSSOP	PW	14	2500	367.0	367.0	35.0
LMH6502MTX/NOPB	TSSOP	PW	14	2500	367.0	367.0	35.0

D (R-PDSO-G14)

PLASTIC SMALL OUTLINE





- NOTES:
- A. All linear dimensions are in inches (millimeters).
  - B. This drawing is subject to change without notice.
  - $\triangle C$  Body length does not include mold flash, protrusions, or gate burrs. Mold flash, protrusions, or gate burrs shall not exceed 0.006 (0,15) each side.
  - $\triangle D$  Body width does not include interlead flash. Interlead flash shall not exceed 0.017 (0,43) each side.
  - E. Reference JEDEC MS-012 variation AB.

PW (R-PDSO-G14)

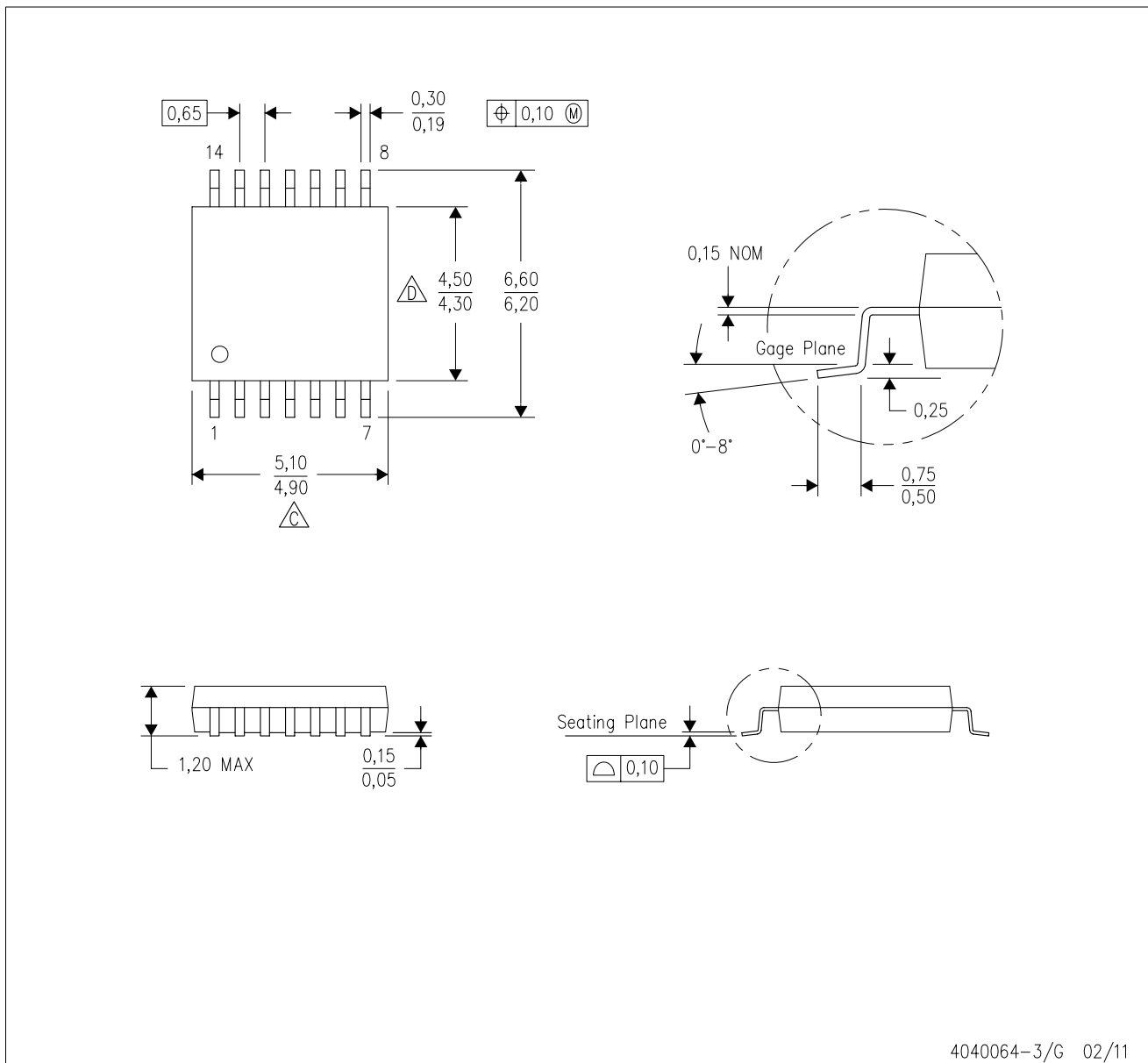
PLASTIC SMALL OUTLINE



4040064-3/G 02/11

- NOTES:
- A. All linear dimensions are in millimeters. Dimensioning and tolerancing per ASME Y14.5M-1994.
  - B. This drawing is subject to change without notice.
  -  C. Body length does not include mold flash, protrusions, or gate burrs. Mold flash, protrusions, or gate burrs shall not exceed 0,15 each side.
  -  D. Body width does not include interlead flash. Interlead flash shall not exceed 0,25 each side.
  - E. Falls within JEDEC MO-153

## IMPORTANT NOTICE

Texas Instruments Incorporated and its subsidiaries (TI) reserve the right to make corrections, enhancements, improvements and other changes to its semiconductor products and services per JESD46, latest issue, and to discontinue any product or service per JESD48, latest issue. Buyers should obtain the latest relevant information before placing orders and should verify that such information is current and complete. All semiconductor products (also referred to herein as "components") are sold subject to TI's terms and conditions of sale supplied at the time of order acknowledgment.

TI warrants performance of its components to the specifications applicable at the time of sale, in accordance with the warranty in TI's terms and conditions of sale of semiconductor products. Testing and other quality control techniques are used to the extent TI deems necessary to support this warranty. Except where mandated by applicable law, testing of all parameters of each component is not necessarily performed.

TI assumes no liability for applications assistance or the design of Buyers' products. Buyers are responsible for their products and applications using TI components. To minimize the risks associated with Buyers' products and applications, Buyers should provide adequate design and operating safeguards.

TI does not warrant or represent that any license, either express or implied, is granted under any patent right, copyright, mask work right, or other intellectual property right relating to any combination, machine, or process in which TI components or services are used. Information published by TI regarding third-party products or services does not constitute a license to use such products or services or a warranty or endorsement thereof. Use of such information may require a license from a third party under the patents or other intellectual property of the third party, or a license from TI under the patents or other intellectual property of TI.

Reproduction of significant portions of TI information in TI data books or data sheets is permissible only if reproduction is without alteration and is accompanied by all associated warranties, conditions, limitations, and notices. TI is not responsible or liable for such altered documentation. Information of third parties may be subject to additional restrictions.

Resale of TI components or services with statements different from or beyond the parameters stated by TI for that component or service voids all express and any implied warranties for the associated TI component or service and is an unfair and deceptive business practice. TI is not responsible or liable for any such statements.

Buyer acknowledges and agrees that it is solely responsible for compliance with all legal, regulatory and safety-related requirements concerning its products, and any use of TI components in its applications, notwithstanding any applications-related information or support that may be provided by TI. Buyer represents and agrees that it has all the necessary expertise to create and implement safeguards which anticipate dangerous consequences of failures, monitor failures and their consequences, lessen the likelihood of failures that might cause harm and take appropriate remedial actions. Buyer will fully indemnify TI and its representatives against any damages arising out of the use of any TI components in safety-critical applications.

In some cases, TI components may be promoted specifically to facilitate safety-related applications. With such components, TI's goal is to help enable customers to design and create their own end-product solutions that meet applicable functional safety standards and requirements. Nonetheless, such components are subject to these terms.

No TI components are authorized for use in FDA Class III (or similar life-critical medical equipment) unless authorized officers of the parties have executed a special agreement specifically governing such use.

Only those TI components which TI has specifically designated as military grade or "enhanced plastic" are designed and intended for use in military/aerospace applications or environments. Buyer acknowledges and agrees that any military or aerospace use of TI components which have **not** been so designated is solely at the Buyer's risk, and that Buyer is solely responsible for compliance with all legal and regulatory requirements in connection with such use.

TI has specifically designated certain components as meeting ISO/TS16949 requirements, mainly for automotive use. In any case of use of non-designated products, TI will not be responsible for any failure to meet ISO/TS16949.

### Products

Audio	<a href="http://www.ti.com/audio">www.ti.com/audio</a>
Amplifiers	<a href="http://amplifier.ti.com">amplifier.ti.com</a>
Data Converters	<a href="http://dataconverter.ti.com">dataconverter.ti.com</a>
DLP® Products	<a href="http://www.dlp.com">www.dlp.com</a>
DSP	<a href="http://dsp.ti.com">dsp.ti.com</a>
Clocks and Timers	<a href="http://www.ti.com/clocks">www.ti.com/clocks</a>
Interface	<a href="http://interface.ti.com">interface.ti.com</a>
Logic	<a href="http://logic.ti.com">logic.ti.com</a>
Power Mgmt	<a href="http://power.ti.com">power.ti.com</a>
Microcontrollers	<a href="http://microcontroller.ti.com">microcontroller.ti.com</a>
RFID	<a href="http://www.ti-rfid.com">www.ti-rfid.com</a>
OMAP Applications Processors	<a href="http://www.ti.com/omap">www.ti.com/omap</a>
Wireless Connectivity	<a href="http://www.ti.com/wirelessconnectivity">www.ti.com/wirelessconnectivity</a>

### Applications

Automotive and Transportation	<a href="http://www.ti.com/automotive">www.ti.com/automotive</a>
Communications and Telecom	<a href="http://www.ti.com/communications">www.ti.com/communications</a>
Computers and Peripherals	<a href="http://www.ti.com/computers">www.ti.com/computers</a>
Consumer Electronics	<a href="http://www.ti.com/consumer-apps">www.ti.com/consumer-apps</a>
Energy and Lighting	<a href="http://www.ti.com/energy">www.ti.com/energy</a>
Industrial	<a href="http://www.ti.com/industrial">www.ti.com/industrial</a>
Medical	<a href="http://www.ti.com/medical">www.ti.com/medical</a>
Security	<a href="http://www.ti.com/security">www.ti.com/security</a>
Space, Avionics and Defense	<a href="http://www.ti.com/space-avionics-defense">www.ti.com/space-avionics-defense</a>
Video and Imaging	<a href="http://www.ti.com/video">www.ti.com/video</a>

### TI E2E Community

[e2e.ti.com](http://e2e.ti.com)