

LMV115 GSM Baseband 30MHz 2.8V Oscillator Buffer

Check for Samples: [LMV115](#)

FEATURES

- (Typical 2.8V Supply; Values Unless Otherwise Specified)
- Low Supply Current: 0.3mA
- 2.5V to 3.3V Supply
- AC Coupling Possible Without External Bias Resistors.
- Includes Shutdown Function External Oscillator
- SC70-6 Pin Package 2.1 x 2mm
- Operating Temperature Range -40°C to 85°C

APPLICATIONS

- Cellular Phones
- GSM Modules
- Oscillator Modules

DESCRIPTION

The LMV115 is a 30MHz buffer specially designed to minimize the effects of spurious signals from the base band chip to the oscillator. The buffer also minimizes the influence of varying load resistance and capacitance to the oscillator and increases the drive capability.

The input of the LMV115 is internally biased with two equal resistors to the power supply rails. This allows AC coupling on the input.

The LMV115 offers a shutdown function to optimize current consumption. This shutdown function can also be used to control the supply voltage of an external oscillator. The device is in shutdown mode when the shutdown pin is connected to V_{DD} .

The LMV115 comes in SC70-6 package. This space saving product reduces components, improves clock signal and allows ease of placement for the best form factor.

Schematic Diagram

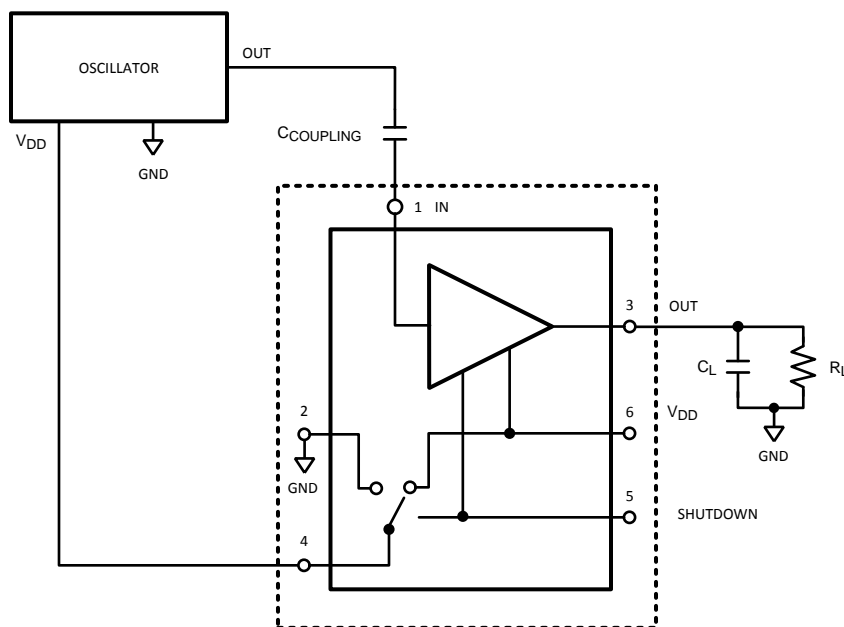

These devices have limited built-in ESD protection. The leads should be shorted together or the device placed in conductive foam during storage or handling to prevent electrostatic damage to the MOS gates.



Please be aware that an important notice concerning availability, standard warranty, and use in critical applications of Texas Instruments semiconductor products and disclaimers thereto appears at the end of this data sheet.

All trademarks are the property of their respective owners.

ABSOLUTE MAXIMUM RATINGS⁽¹⁾⁽²⁾

ESD Tolerance	Human Body Model	2000V ⁽³⁾
	Machine Model	150V ⁽⁴⁾
Supply Voltage ($V^+ - V^-$)		3.6V
Output Short Circuit to V^+		See ⁽⁵⁾⁽⁶⁾
Output Short Circuit to V^-		See ⁽⁵⁾⁽⁶⁾
Storage Temperature Range		-65°C to +150°C
Junction Temperature ⁽⁷⁾		+150°C
Mounting Temperature	Infrared or Convection (20 sec.)	235°C

- (1) Absolute Maximum Ratings indicate limits beyond which damage to the device may occur. Operating Ratings indicate conditions for which the device is intended to be functional, but specific performance is not ensured. For ensured specifications and the test conditions, see the Electrical Characteristics.
- (2) If Military/Aerospace specified devices are required, please contact the TI Sales Office/ Distributors for availability and specifications.
- (3) Human Body Model (HBM) is 1.5k Ω in series with 100pF.
- (4) Machine Model, 0 Ω in series with 200pF.
- (5) Applies to both single-supply and split-supply operation. Continuous short circuit operation at elevated ambient temperature can result in exceeding the maximum allowed junction temperature of 150°C.
- (6) Infinite Duration; Short circuit test is a momentary test. See [Note 7](#).
- (7) The maximum power dissipation is a function of $T_{J(MAX)}$, θ_{JA} , and T_A . The maximum allowable power dissipation at any ambient temperature is $P_D = (T_{J(MAX)} - T_A) / \theta_{JA}$. All numbers apply for packages soldered directly onto a PC board.

OPERATING RATINGS⁽¹⁾

Supply Voltage ($V^+ - V^-$)		2.5V to 3.3V
Temperature Range ⁽²⁾⁽³⁾		-40°C to +85°C
Package Thermal Resistance ⁽²⁾⁽³⁾	SC70-6	414°C/W

- (1) Absolute Maximum Ratings indicate limits beyond which damage to the device may occur. Operating Ratings indicate conditions for which the device is intended to be functional, but specific performance is not ensured. For ensured specifications and the test conditions, see the Electrical Characteristics.
- (2) The maximum power dissipation is a function of $T_{J(MAX)}$, θ_{JA} , and T_A . The maximum allowable power dissipation at any ambient temperature is $P_D = (T_{J(MAX)} - T_A) / \theta_{JA}$. All numbers apply for packages soldered directly onto a PC board.
- (3) Electrical Table values apply only for factory testing conditions at the temperature indicated. Factory testing conditions result in very limited self-heating of the device such that $T_J = T_A$. There is no ensured parametric performance as indicated in the electrical tables under conditions of internal self-heating where $T_J > T_A$. See [APPLICATION SECTION](#) for information on temperature de-rating of this device.

2.8V ELECTRICAL CHARACTERISTICS

Unless otherwise specified, all limits specified for $T_J = 25^\circ\text{C}$, $V^+ = 2.8\text{V}$, $V^- = 0\text{V}$, $V_{CM} = V^+/2$, shutdown = 0.0V, and $R_L = 50\text{k}\Omega$ to $V^+/2$, $C_L = 5\text{pF}$ to $V^+/2$ and $C_{COUPLING} = 1\text{nF}$. **Boldface** limits apply at the temperature extremes.

Symbol	Parameter	Conditions	Min ⁽¹⁾	Typ ⁽²⁾	Max ⁽¹⁾	Units
SSBW	Small Signal Bandwidth	$V_{OUT} < 0.5V_{PP}$; -3dB		31		MHz
GFN	Gain Flatness < 0.1dB	$f > 50\text{kHz}$		2.8		MHz
FPBW	Full Power Bandwidth (-3dB)	$V_{OUT} = 1.0V_{PP}$ (+4.5dBm)		9		MHz
Time Domain Response						
t_r	Rise Time	0.1V _{STEP} (10-90%)		11		ns
t_f	Fall Time			11		
t_s	Settling Time to 0.1%	0.1V _{STEP}		95		ns
OS	Overshoot	0.1V _{STEP}		24		%
SR	Slew Rate	See ⁽³⁾		18		V/ μs

- (1) All limits are specified by testing or statistical analysis.
- (2) Typical Values represent the most likely parametric norm.
- (3) Slew rate is the average of the positive and negative slew rate.

2.8V ELECTRICAL CHARACTERISTICS (continued)

Unless otherwise specified, all limits specified for $T_j = 25^\circ\text{C}$, $V^+ = 2.8\text{V}$, $V^- = 0\text{V}$, $V_{\text{CM}} = V^+/2$, shutdown = 0.0V, and $R_L = 50\text{k}\Omega$ to $V^+/2$, $C_L = 5\text{pF}$ to $V^+/2$ and $C_{\text{COUPLING}} = 1\text{nF}$. **Boldface** limits apply at the temperature extremes.

Symbol	Parameter	Conditions	Min ⁽¹⁾	Typ ⁽²⁾	Max ⁽¹⁾	Units
Distortion and Noise Performance						
HD2	2 nd Harmonic Distortion	$V_{\text{OUT}} = 500\text{mV}_{\text{PP}}$; $f = 100\text{kHz}$		-41		dBc
HD3	3 rd Harmonic Distortion	$V_{\text{OUT}} = 500\text{mV}_{\text{PP}}$; $f = 100\text{kHz}$		-43		dBc
THD	Total Harmonic Distortion	$V_{\text{OUT}} = 500\text{mV}_{\text{PP}}$; $f = 100\text{kHz}$		-38		dBc
e_n	Input-Referred Voltage Noise	$f = 1\text{MHz}$		27		$\text{nV}/\sqrt{\text{Hz}}$
Isolation	Output to Input	See also TYPICAL PERFORMANCE CHARACTERISTICS		>40		dB
Static DC Performance						
A_{CL}	Small Signal Voltage Gain	$V_{\text{OUT}} = 100\text{mV}_{\text{PP}}$	0.90 0.85	0.998	1.10 1.11	V/V
V_{OS}	Output Offset Voltage			3.5	35 55	mV
TC V_{OS}	Temperature Coefficient Output Offset Voltage	See ⁽⁴⁾		102		$\mu\text{V}/^\circ\text{C}$
R_{OUT}	Output Resistance	$f = 10\text{kHz}$ $f = 25\text{MHz}$		61 330		Ω
PSRR	Power Supply Rejection Ratio	$V^+ = 2.8\text{V}$ to $V^+ = 3.3\text{V}$	41 38	42		dB
I_S	Supply Current	No Load; Shutdown = 2.8V No Load; Shutdown = 0V		0.0 314	2.00 450 520	μA
Miscellaneous Performance						
R_{IN}	Input Resistance	Shutdown = 2.8V Shutdown = 0V		65 64		$\text{k}\Omega$
C_{IN}	Input Capacitance	Shutdown = 2.8V Shutdown = 0V		1.82 1.50		pF
Z_{IN}	Input Impedance	$f = 25\text{MHz}$; Shutdown = 2.8V $f = 25\text{MHz}$; Shutdown = 0V		2.38 2.47		$\text{k}\Omega$
V_O	Output Swing Positive ⁽⁵⁾	$R_L = 50\text{k}\Omega$ to $V^+/2$	1.90 1.65	2.16		V
	Output Swing Negative	$R_L = 50\text{k}\Omega$ to $V^+/2$		1.05	1.35 1.30	
I_O	Linear Output Current	No Load; $V_{\text{OUT}} = V^+ - 1.1\text{V}$ (Sourcing) No Load; $V_{\text{OUT}} = V^- + 1.1\text{V}$ (Sinking)	-90 -35 100 50	-206 205		μA
I_{SC}	Output Short-Circuit Current ⁽⁶⁾	No Load; Sourcing to $V^+/2$ No Load; Sinking from $V^+/2$	-90 -35 100 50	-186 191		μA
R_{ON}	Switch in ON Position			21	40 45	Ω

(4) Average Temperature Coefficient is determined by dividing the change in a parameter at temperature extremes by the total temperature change.

(5) Positive current corresponds to current flowing into the device.

(6) Infinite Duration; Short circuit test is a momentary test. See [Note 7](#) under Absolute Maximum Ratings.

CONNECTION DIAGRAM

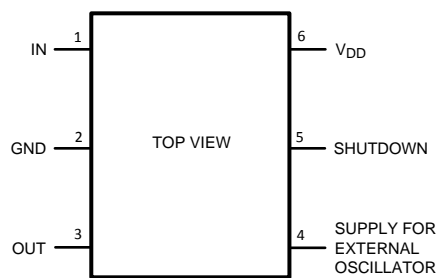

Figure 1. SC70-6 - Top View

TYPICAL PERFORMANCE CHARACTERISTICS

$T_J = 25^\circ\text{C}$, $V^+ = 2.8\text{V}$, $V^- = 0\text{V}$, $V_{CM} = V^+/2$, and R_L, C_L is connected to $V^+/2$; Unless otherwise specified.

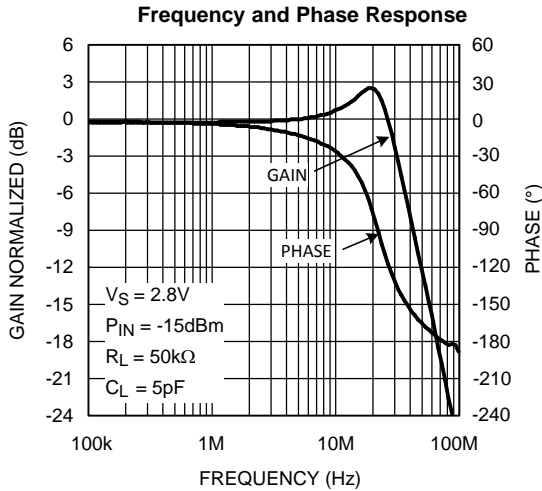

Figure 2.

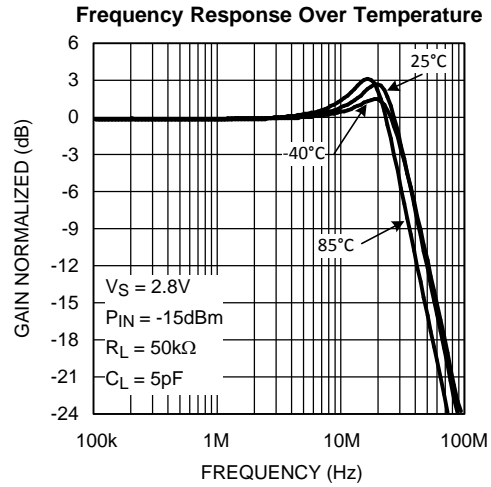

Figure 3.

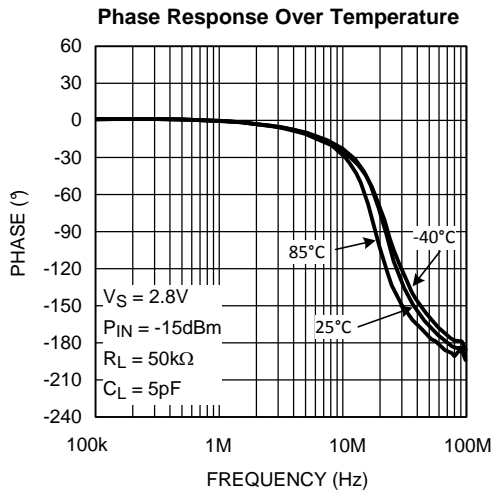

Figure 4.

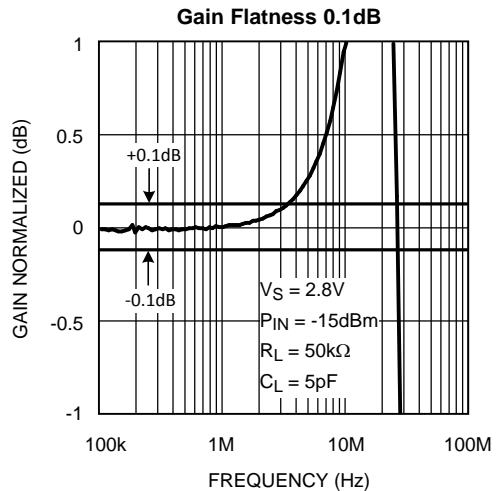

Figure 5.

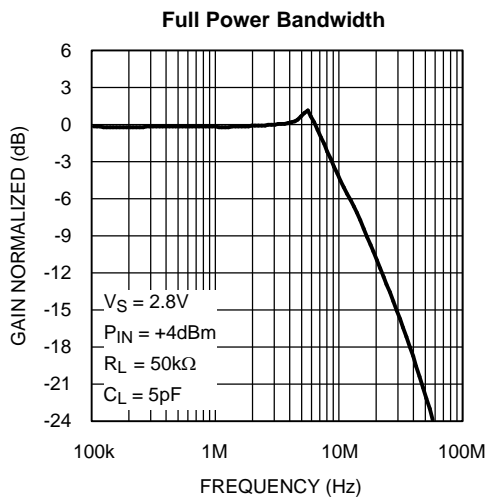

Figure 6.

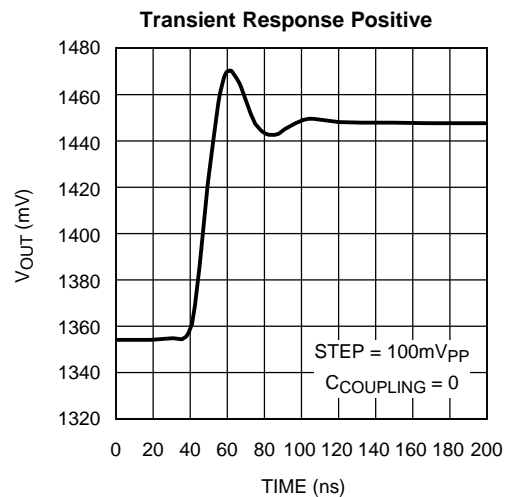

Figure 7.

TYPICAL PERFORMANCE CHARACTERISTICS (continued)

$T_J = 25^\circ\text{C}$, $V^+ = 2.8\text{V}$, $V^- = 0\text{V}$, $V_{CM} = V^+/2$, and R_L, C_L is connected to $V^+/2$; Unless otherwise specified.

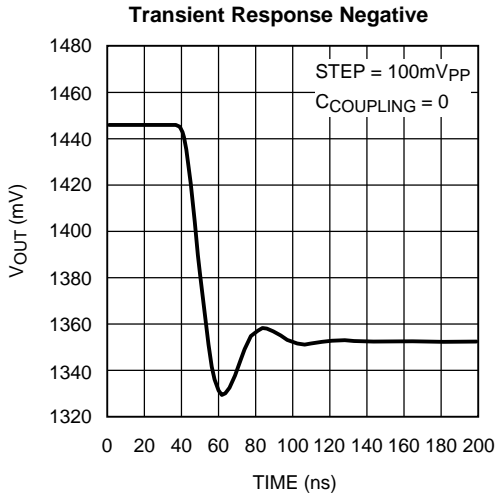

Figure 8.

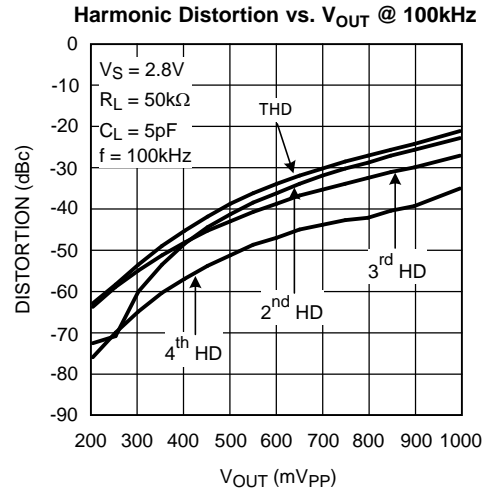

Figure 9.

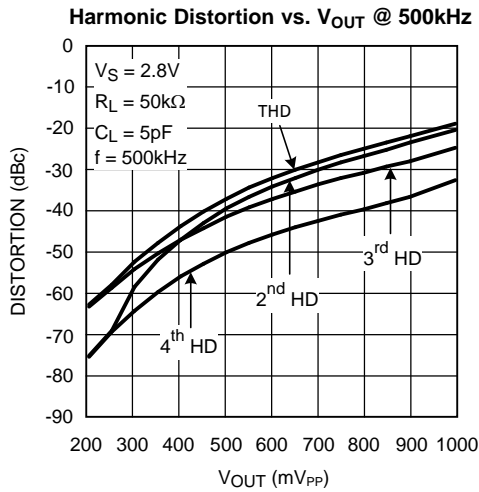

Figure 10.

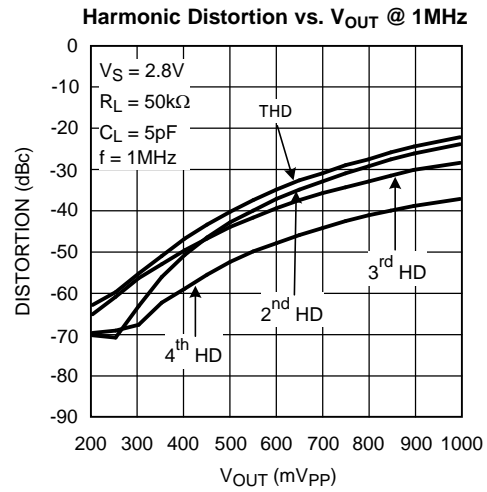

Figure 11.

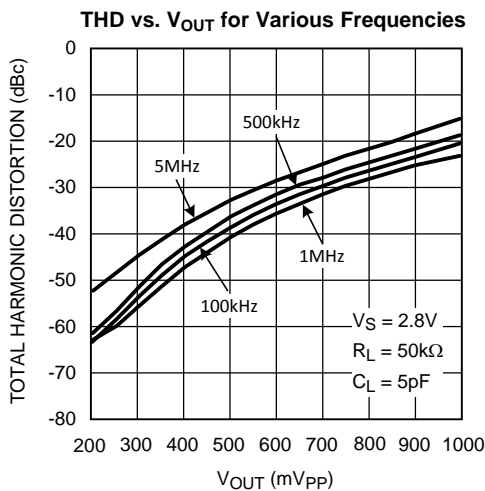

Figure 12.

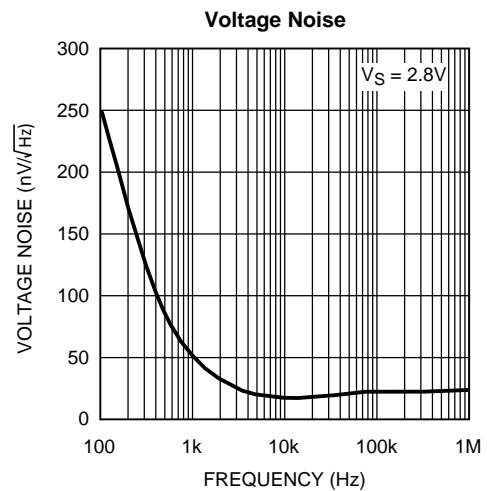

Figure 13.

TYPICAL PERFORMANCE CHARACTERISTICS (continued)

$T_J = 25^\circ\text{C}$, $V^+ = 2.8\text{V}$, $V^- = 0\text{V}$, $V_{CM} = V^+/2$, and R_L, C_L is connected to $V^+/2$; Unless otherwise specified.

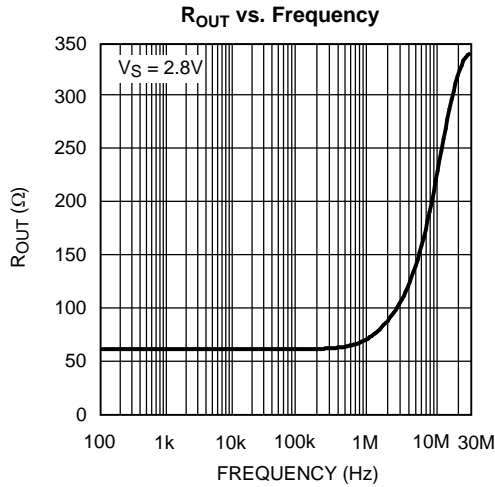

Figure 14.

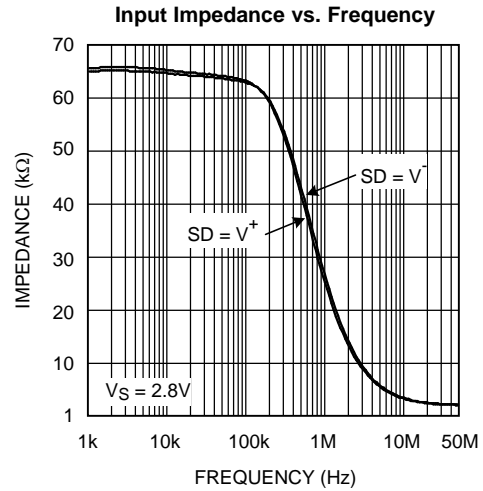

Figure 15.

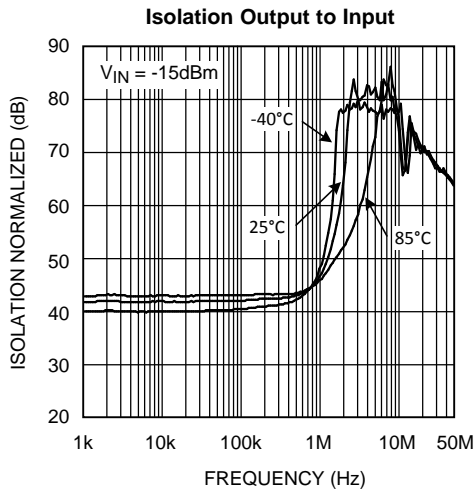

Figure 16.

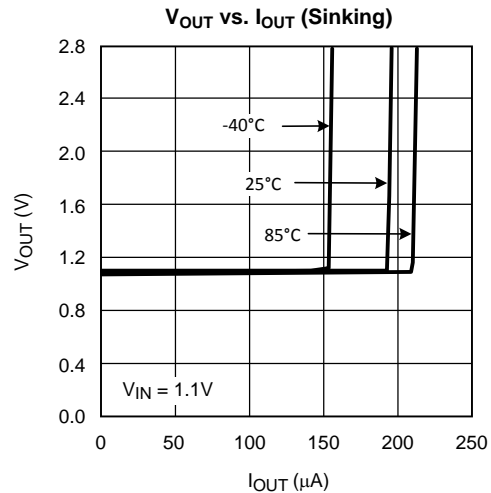

Figure 17.

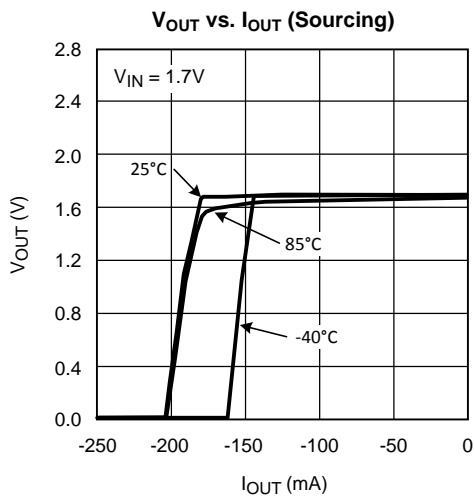

Figure 18.

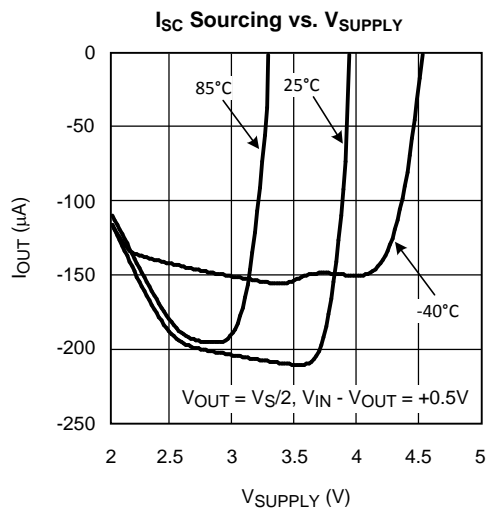

Figure 19.

TYPICAL PERFORMANCE CHARACTERISTICS (continued)

$T_J = 25^\circ\text{C}$, $V^+ = 2.8\text{V}$, $V^- = 0\text{V}$, $V_{CM} = V^+/2$, and R_L, C_L is connected to $V^+/2$; Unless otherwise specified.

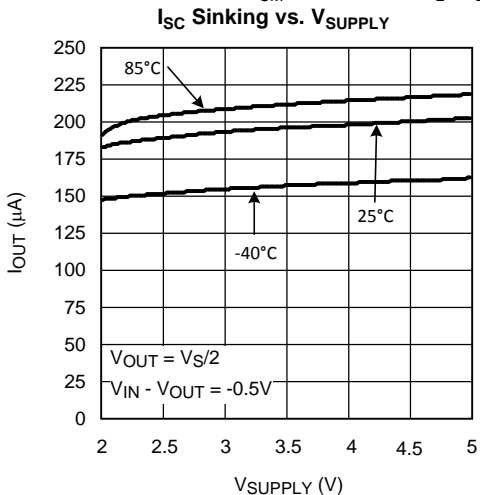

Figure 20.

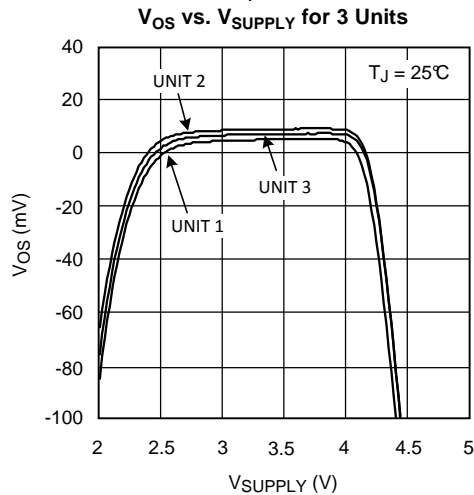

Figure 21.

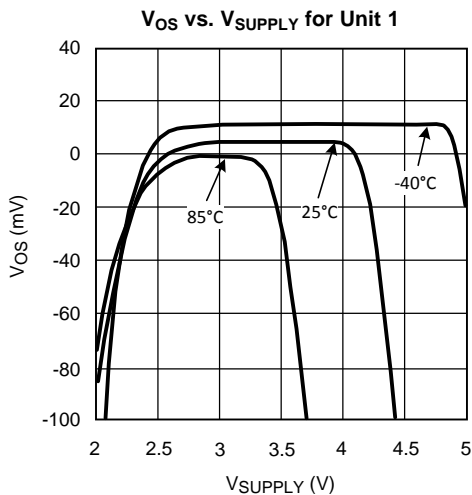

Figure 22.

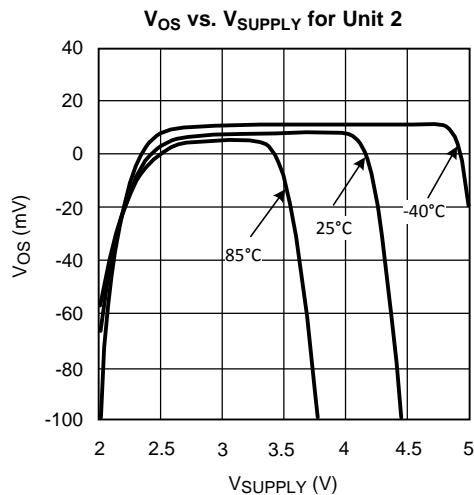

Figure 23.

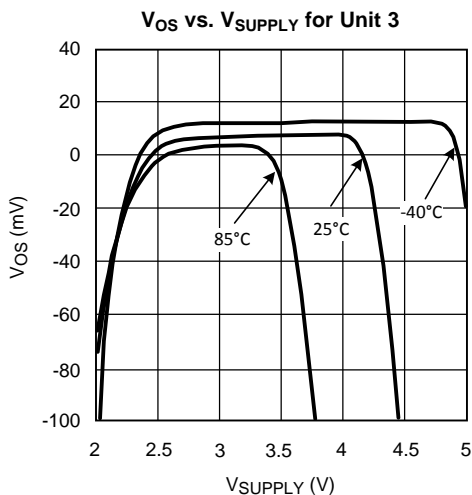

Figure 24.

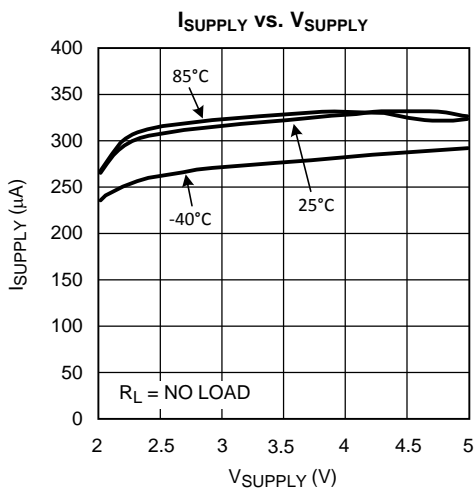

Figure 25.

TYPICAL PERFORMANCE CHARACTERISTICS (continued)

$T_J = 25^\circ\text{C}$, $V^+ = 2.8\text{V}$, $V^- = 0\text{V}$, $V_{CM} = V^+/2$, and R_L , C_L is connected to $V^+/2$; Unless otherwise specified.

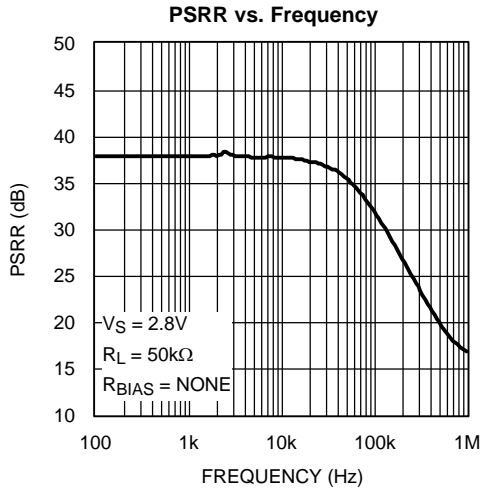

Figure 26.

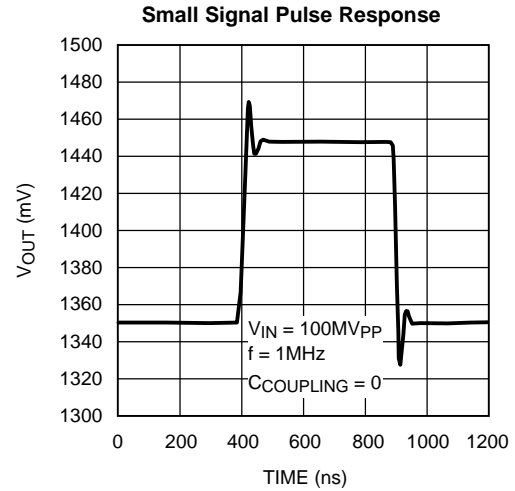

Figure 27.

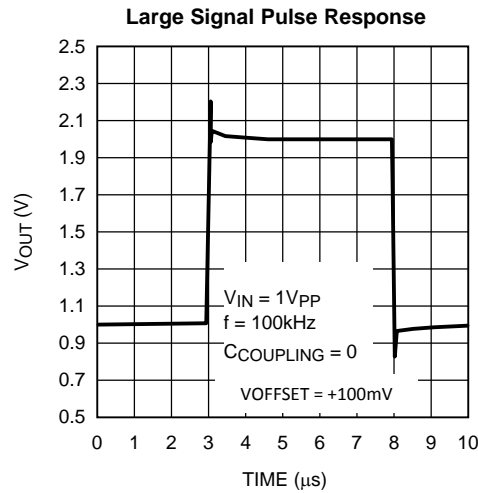

Figure 28.

APPLICATION SECTION

GENERAL

The LMV115 is specially designed to minimize the effects of spurious signals from the base band chip to the oscillator. Beside this the influence of varying load resistance and capacitance to the oscillator is minimized, while increasing the drive capability. The input of the LMV115 is internally biased with two equal resistors to the power supply rails, and makes AC coupling possible without external bias resistors at the input. The LMV115 has excellent gain phase margin. The LMV115 offers a shutdown pin that can be used to disable the device in order to optimize current consumption and also has a feature to control the supply voltage to an external oscillator. When the shutdown pin is connected to V_{DD} the device is in shutdown mode.

SWITCHED POWER SUPPLY CONNECTION

The LMV115 features an enable/disable function for an external oscillator by controlling its supply voltage (pin 4). See also the [Schematic Diagram](#) on the front page. During normal operating mode, pin 4 is connected to the positive supply rail via an internal switch. The resistance between the positive supply rail and pin 4, R_{ON} , is specified in the electrical characterization table. Oscillators with a supply current up to several milliamps can easily be powered from pin 4. During shutdown, pin 4 is switched to the negative supply rail. The simplified schematic for this part of the device is shown in [Figure 29](#)

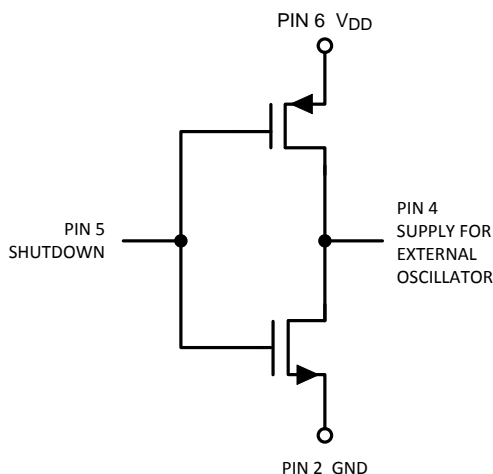

Figure 29. Supply For External Oscillator

INPUT CONFIGURATION

The input of the LMV115 is internally biased at mid-supply by a divider of two equal resistors. With the LMV115 in shutdown mode, the internal resistor connected to the V_{DD} is shorted to the negative power supply rail via a switch. This makes the power consumption in 'off' mode almost zero, but causes a small difference for the input impedance between the on and off modes. Both resistors are 110k Ω so the resulting input impedance will be approximately 55k Ω . The input configuration allows AC coupling on the input of the LMV115. A simplified schematic of the input is shown in [Figure 30](#).

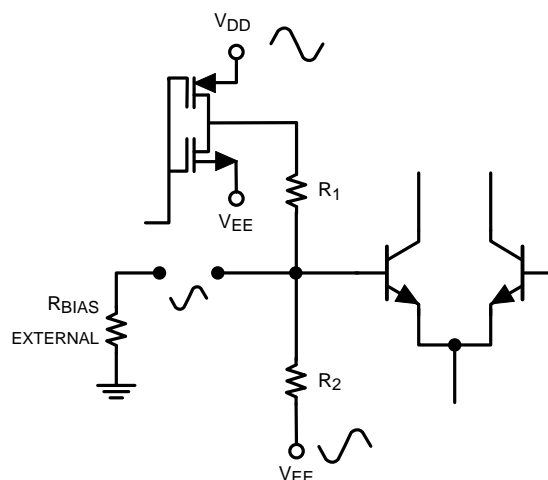

Figure 30. Dual Supply Mode

PSRR

If an AC signal is applied to one of the supply lines, while the input is floating, the signal at the input pin is half the signal at the supply line, causing the same signal at the output of the buffer. This will result in a PSRR of only 6dB (see Figure 30).

In a typical application the input is driven from a low ohmic source that means the disturbance at the supply lines is attenuated by the series resistors of 110k and the source impedance. In case the buffer is connected to a 50Ω source, the resulting suppression will be $20 \cdot \log \left[\frac{R_1 + R_{BIAS}}{R_{BIAS}} \right] = 67\text{dB}$ for signals at the supply line. The PSRR can also be measured correctly for this type of input by shortening the input to mid-supply. Due to the internal structure it is not recommended to measure with the input connected to ground. To measure correctly the PSRR, two signals are applied to both V_{DD} and V_{EE} but with 180° phase difference (see Figure 30). In this case, both signals are subtracted and there will be no signal at the input. The resulting disturbance at the output is now only caused by the signals at the supply lines.

INPUT AND OUTPUT LEVEL

Due to the internal loop gain of 1, the output will follow the input. The output voltage cannot swing as close to the supply rail as the input voltage. For linear operation the input voltage swing should not exceed the output voltage swing. The restrictions for the output voltage can be examined by the two curves in Figure 31. The curve V_{OUT} (V) shows the response of the output signal versus the input signal and the curve $V_{OUT} - V_{IN}$ (V) shows the difference between the output and the input signal.

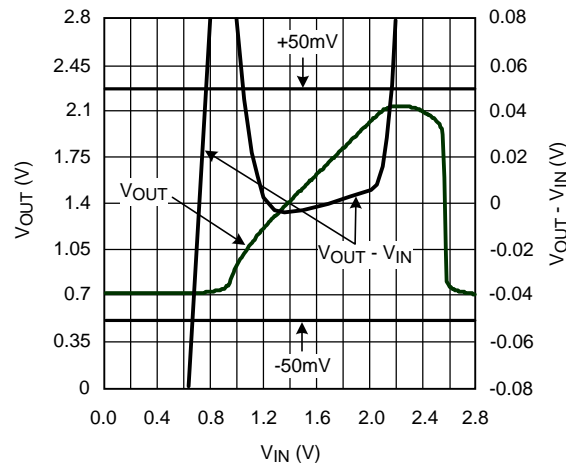

Figure 31. $V_{OUT} - V_{IN}$

In [Figure 31](#) the input signal is swept between both supply rails (0V - 2.8V). The linear part of the plot ' V_{OUT} vs. V_{IN} ' covers approximately the voltage range between 1.0V and 2.0V. If a difference of 50mV between output and input is acceptable, the output range is between 1.05V and 2.15V (see curve $V_{OUT} - V_{IN}$). Alternatively the output voltage swing can be determined by using [Figure 32](#). In the plot 'Gain vs. V_{IN} ' it can be seen that the gain is flat for input voltages from 1.15V till 2.1V. Outside this range the gain differs from 1. This will introduce distortion of the output signal.

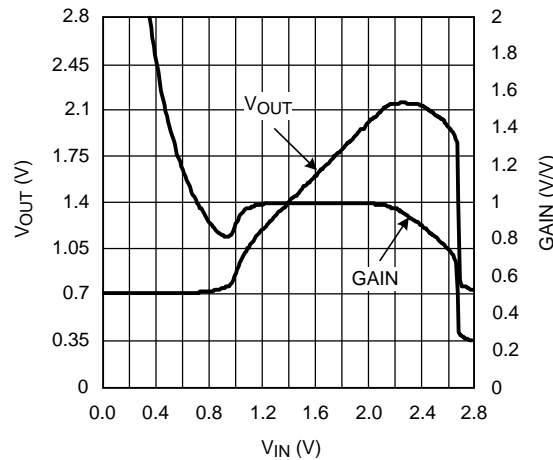

Figure 32. Gain

Another point is the DC bias voltage necessary to get the optimum output voltage swing. As discussed above, the output voltage swing can be $1V_{PP}$, but if the two internal bias resistors are used, the DC bias will be 1.4V, which is half of the supply voltage of 2.8V. In this situation the output swing will exceed the lower limit of 1.15V, so it is necessary to introduce a small DC offset of 200mV to make use of the full output swing range of the output stage.

DRIVING RESISTIVE AND CAPACITIVE LOADS

The maximum output current of the LMV115 is about 200 μ A which means the output can drive a maximum load of $1V/200\mu A = 5k\Omega$. Using lower load resistances will exceed the maximum linear output current. The LMV115 can drive a small capacitive load, but make sure that every capacitor directly connected to the output becomes part of the loop of the buffer and will reduce the gain/phase margin, increasing the instability at higher capacitive values. This will lead to peaking in the frequency response and in extreme situations oscillations can occur. A good practice when driving larger capacitive loads is to include a series resistor to the load capacitor. A to D converters present complex and varying capacitive loads to the buffer. The best value for this isolation resistance is often found by experimentation.

SHUTDOWN MODE

LMV115 offers a shutdown function that can be used to disable the device and to optimize current consumption. Switching between the normal mode and the shutdown mode requires connecting the shutdown pin either to the negative or the positive supply rail. If directly connected to one of the supply rails, the part is specified in the correct mode. But if the shutdown pin is driven by other output stages, there is a voltage range in which the installed mode is not certainly set and it is recommended not to drive the shutdown pin in this voltage range. As can be seen in [Figure 33](#) this hysteresis varies from 1V to 1.6V. Below 1V the LMV115 is securely 'ON' and above 1.6V securely 'OFF' while using a supply voltage of 2.8V.

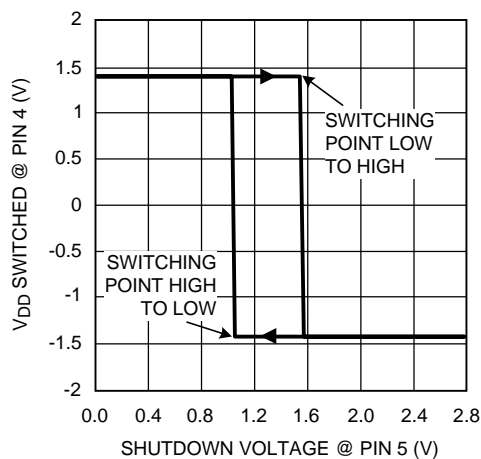

Figure 33. Hysteresis

PRINTED CIRCUIT BOARD LAYOUT AND COMPONENT VALUES SELECTION

For a good high frequency design both the active parts and the passive ones should be suitable for the purpose they are used for. Amplifying high frequencies is possible with standard through-hole components, but for frequencies above several hundreds of MHz the best choice is using surface mount devices. Nowadays designs are often assembled with surface mount devices for the aspect of minimizing space, but this also greatly improves the performance of designs, handling high frequencies. Another important issue is the PCB, which is no longer a simple carrier for all the parts and a medium to interconnect them. The board becomes a real part itself, adding its own high frequency properties to the overall performance of the circuit. It is good practice to have at least one ground plane on a PCB giving a low impedance path for all decoupling and other ground connections. In order to achieve high immunity for unwanted signals from outside, it is important to place the components as flat as possible on the PCB. Be aware that a long lead can act as an inductor, a capacitor or an antenna. A pair of leads can even form a transformer. Careful design of the PCB avoids oscillations or other unwanted behavior. Another important issue is the value of components, which also determines the sensitivity to pick-up unwanted signals. Choose the value of resistors as low as possible, but avoid using values that causes a significant increase in power consumption, while loading inputs or outputs to heavily.

TI suggests the following evaluation board as a guide for high frequency layout and as an aid in device testing and characterization.

Device	Package	Evaluation Board PN
LMV115	SC70-6	LMV115/117 Eval Board

This free evaluation board is shipped when a device sample request is placed with TI.

REVISION HISTORY

Changes from Revision A (April 2013) to Revision B	Page
• Changed layout of National Data Sheet to TI format	14

IMPORTANT NOTICE

Texas Instruments Incorporated and its subsidiaries (TI) reserve the right to make corrections, enhancements, improvements and other changes to its semiconductor products and services per JESD46, latest issue, and to discontinue any product or service per JESD48, latest issue. Buyers should obtain the latest relevant information before placing orders and should verify that such information is current and complete. All semiconductor products (also referred to herein as "components") are sold subject to TI's terms and conditions of sale supplied at the time of order acknowledgment.

TI warrants performance of its components to the specifications applicable at the time of sale, in accordance with the warranty in TI's terms and conditions of sale of semiconductor products. Testing and other quality control techniques are used to the extent TI deems necessary to support this warranty. Except where mandated by applicable law, testing of all parameters of each component is not necessarily performed.

TI assumes no liability for applications assistance or the design of Buyers' products. Buyers are responsible for their products and applications using TI components. To minimize the risks associated with Buyers' products and applications, Buyers should provide adequate design and operating safeguards.

TI does not warrant or represent that any license, either express or implied, is granted under any patent right, copyright, mask work right, or other intellectual property right relating to any combination, machine, or process in which TI components or services are used. Information published by TI regarding third-party products or services does not constitute a license to use such products or services or a warranty or endorsement thereof. Use of such information may require a license from a third party under the patents or other intellectual property of the third party, or a license from TI under the patents or other intellectual property of TI.

Reproduction of significant portions of TI information in TI data books or data sheets is permissible only if reproduction is without alteration and is accompanied by all associated warranties, conditions, limitations, and notices. TI is not responsible or liable for such altered documentation. Information of third parties may be subject to additional restrictions.

Resale of TI components or services with statements different from or beyond the parameters stated by TI for that component or service voids all express and any implied warranties for the associated TI component or service and is an unfair and deceptive business practice. TI is not responsible or liable for any such statements.

Buyer acknowledges and agrees that it is solely responsible for compliance with all legal, regulatory and safety-related requirements concerning its products, and any use of TI components in its applications, notwithstanding any applications-related information or support that may be provided by TI. Buyer represents and agrees that it has all the necessary expertise to create and implement safeguards which anticipate dangerous consequences of failures, monitor failures and their consequences, lessen the likelihood of failures that might cause harm and take appropriate remedial actions. Buyer will fully indemnify TI and its representatives against any damages arising out of the use of any TI components in safety-critical applications.

In some cases, TI components may be promoted specifically to facilitate safety-related applications. With such components, TI's goal is to help enable customers to design and create their own end-product solutions that meet applicable functional safety standards and requirements. Nonetheless, such components are subject to these terms.

No TI components are authorized for use in FDA Class III (or similar life-critical medical equipment) unless authorized officers of the parties have executed a special agreement specifically governing such use.

Only those TI components which TI has specifically designated as military grade or "enhanced plastic" are designed and intended for use in military/aerospace applications or environments. Buyer acknowledges and agrees that any military or aerospace use of TI components which have **not** been so designated is solely at the Buyer's risk, and that Buyer is solely responsible for compliance with all legal and regulatory requirements in connection with such use.

TI has specifically designated certain components as meeting ISO/TS16949 requirements, mainly for automotive use. In any case of use of non-designated products, TI will not be responsible for any failure to meet ISO/TS16949.

Products

Audio	www.ti.com/audio
Amplifiers	amplifier.ti.com
Data Converters	dataconverter.ti.com
DLP® Products	www.dlp.com
DSP	dsp.ti.com
Clocks and Timers	www.ti.com/clocks
Interface	interface.ti.com
Logic	logic.ti.com
Power Mgmt	power.ti.com
Microcontrollers	microcontroller.ti.com
RFID	www.ti-rfid.com
OMAP Applications Processors	www.ti.com/omap
Wireless Connectivity	www.ti.com/wirelessconnectivity

Applications

Automotive and Transportation	www.ti.com/automotive
Communications and Telecom	www.ti.com/communications
Computers and Peripherals	www.ti.com/computers
Consumer Electronics	www.ti.com/consumer-apps
Energy and Lighting	www.ti.com/energy
Industrial	www.ti.com/industrial
Medical	www.ti.com/medical
Security	www.ti.com/security
Space, Avionics and Defense	www.ti.com/space-avionics-defense
Video and Imaging	www.ti.com/video

TI E2E Community

e2e.ti.com