



These devices have limited built-in ESD protection. The leads should be shorted together or the device placed in conductive foam during storage or handling to prevent electrostatic damage to the MOS gates.

Absolute Maximum Ratings⁽¹⁾⁽²⁾⁽³⁾

Supply Voltage (V_{CC})		+250V
Bias Voltage (V_{BB})		+16V
Input Voltage (V_{IN})		-0.5V to $V_{BB} + 0.5V$
Storage Temperature Range (T_{STG})		-65°C to +150°C
Lead Temperature	Soldering, <10 sec.	300°C
ESD Tolerance	Machine Model	200V
Junction Temperature		150°C
θ_{JC} (typ)		2.2°C/W

- (1) All voltages are measured with respect to GND, unless otherwise specified.
(2) Absolute Maximum Ratings indicate limits beyond which damage to the device may occur.
(3) If Military/Aerospace specified devices are required, please contact the Texas Instruments Sales Office/ Distributors for availability and specifications.

Operating Ratings⁽¹⁾

V_{CC}	+100V to +230V
V_{BB}	+7V to +13V
V_{IN}	+0V to +5V
V_{OUT}	+40V to +215V
Case Temperature (Do not operate the part without a heat sink.)	110°C

- (1) Operating ratings indicate conditions for which the device is functional, but do not ensure specific performance limits. For ensured specifications and test conditions, see the Electrical Characteristics. Datasheet min/max specification limits are specified by design, test, or statistical analysis. The ensured specifications apply only for the test conditions listed. Some performance characteristics may change when the device is not operated under the listed test conditions.

Electrical Characteristics

(See [Figure 3](#) for Test Circuit)

Unless otherwise noted: $V_{CC} = +220V$, $V_{BB} = +12V$, $C_L = 10$ pF, $T_C = 50^\circ C$.

DC Tests: $V_{IN} = +2.75V_{DC}$.

AC Tests: Output = $130V_{PP}$ (60V – 190V) at 1 MHz.

Symbol	Parameter	Conditions	LM2423			Units
			Min	Typ	Max	
I_{CC}	Supply Current	No Input Signal, No Video Input, No Output Load	14	21	28	mA
I_{BB}	Bias Current		9	15	22	mA
$V_{OUT, 1}$	DC Output Voltage	No AC Input Signal, $V_{IN} = 2.75V_{DC}$	120	125	130	V_{DC}
$V_{OUT, 2}$	DC Output Voltage	No AC Input Signal, $V_{IN} = 1.25V_{DC}$	200	205	210	V_{DC}
A_V	DC Voltage Gain	No AC Input Signal	-51	-54	-57	V/V
ΔA_V	Gain Matching	No AC Input Signal ⁽¹⁾		1.0		dB
LE	Linearity Error	No AC Input Signal ⁽¹⁾⁽²⁾		8		%
t_r	Rise Time, 60V to 190V	10% to 90% ⁽³⁾		22		ns
+OS	Overshoot			8		%
t_f	Fall Time, 60V to 190V	w 90% to 10% ⁽³⁾		21		ns
-OS	Overshoot	See ⁽³⁾		4		%

- (1) Calculated value from Voltage Gain test on each channel.
(2) Linearity Error is the variation in DC gain from $V_{IN} = 1.15V$ to $V_{IN} = 4.35V$.
(3) Input from signal generator: $t_r, t_f < 1$ ns.

AC Test Circuit

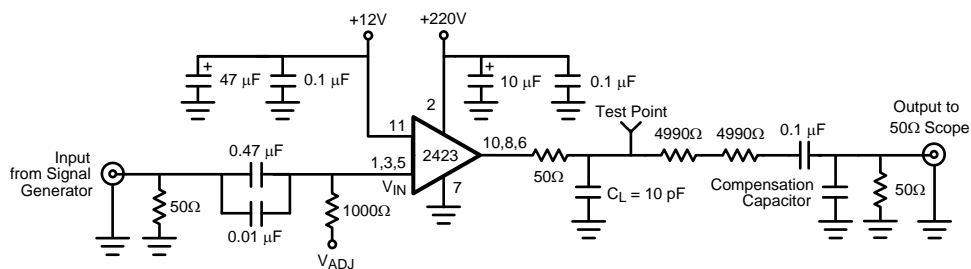

Note: 10 pF load includes parasitic capacitance.

Figure 3. Test Circuit (One Channel)

Figure 3 shows a typical test circuit for evaluation of the LM2423. This circuit is designed to allow testing of the LM2423 in a 50Ω environment without the use of an expensive FET probe. The two 4990Ω resistors form a 400:1 divider with the 50Ω resistor and the oscilloscope. A test point is included for easy use of an oscilloscope probe. The compensation capacitor is used to compensate the network to achieve flat frequency response.

Typical Performance Characteristics 50°C

($V_{CC} = +220V_{DC}$, $V_{BB} = +12V_{DC}$, $C_L = 10\text{ pF}$, $V_{OUT} = 130V_{PP}$ (60V – 190V), $T_C = 50^\circ\text{C}$, Test Circuit—[Figure 3](#) unless otherwise specified)

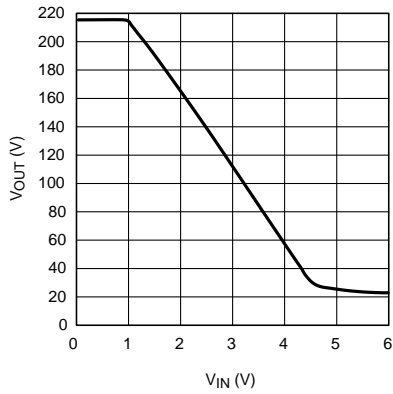

Figure 4. V_{OUT} vs V_{IN}

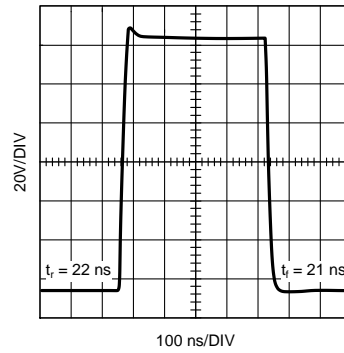

Figure 5. LM2423 Pulse Response

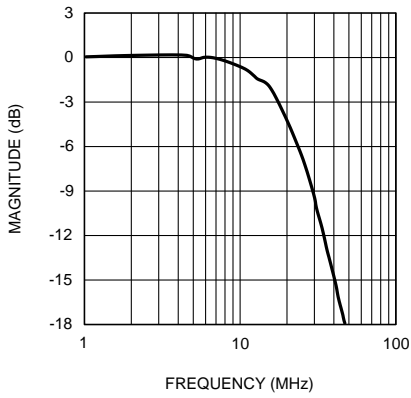

Figure 6. Bandwidth

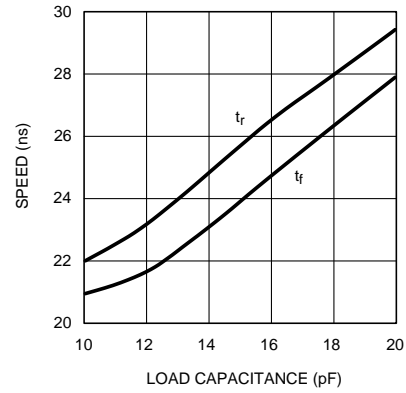

Figure 7. Speed vs Load Capacitance

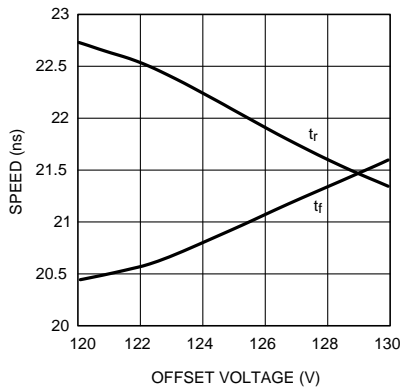

Figure 8. Speed vs Offset

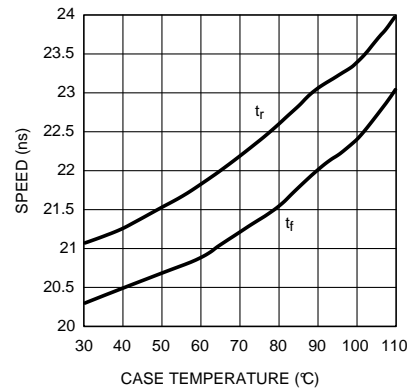

Figure 9. Speed vs Case Temperature

Typical Performance Characteristics 60°C

($V_{CC} = +220V_{DC}$, $V_{BB} = +12V_{DC}$, $C_L = 10\text{ pF}$, $V_{OUT} = 130V_{PP}$ (60V – 190V), $T_C = 60^\circ\text{C}$, Test Circuit—[Figure 3](#) unless otherwise specified)

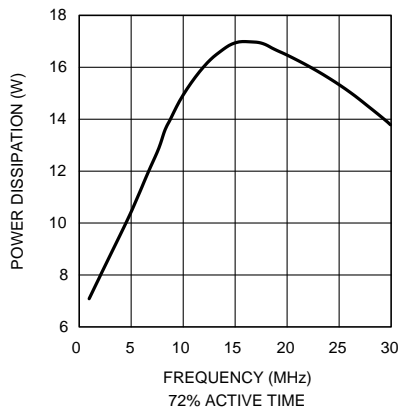

Figure 10. Power Dissipation vs Frequency

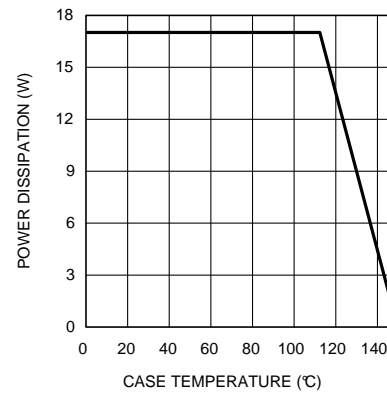

Figure 11. Safe Operating Area

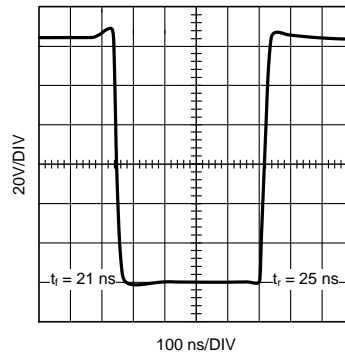

Figure 12. LM2423 Cathode Response

THEORY OF OPERATION

The LM2423 is a high voltage monolithic three channel CRT driver suitable for DTV applications. The LM2423 operates with 220V and 12V power supplies. The part is housed in the industry standard 11-lead TO-220 molded plastic power package with thin leads for improved metal-to-metal spacing.

The circuit diagram of the LM2423 is shown in [Figure 2](#). The PNP emitter follower, Q5, provides input buffering. Q1 and Q2 form a fixed gain cascode amplifier with resistors R1 and R2 setting the gain at -54 . Emitter followers Q3 and Q4 isolate the high output impedance of the cascode stage from the capacitance of the CRT cathode, which decreases the sensitivity of the device to load capacitance. Q6 provides biasing to the output emitter follower stage to reduce crossover distortion at low signal levels.

[Figure 3](#) shows a typical test circuit for evaluation of the LM2423. This circuit is designed to allow testing of the LM2423 in a 50 Ω environment without the use of an expensive FET probe. In this test circuit, the two 4.99 k Ω resistors form a 400:1 wideband, low capacitance probe when connected to a 50 Ω coaxial cable and a 50 Ω load (such as a 50 Ω oscilloscope input). The input signal from the generator is ac coupled to the base of Q5.

Application Hints

INTRODUCTION

Texas Instruments is committed to provide application information that assists our customers in obtaining the best performance possible from our products. The following information is provided in order to support this commitment. The reader should be aware that the optimization of performance was done using a specific printed circuit board designed at TI. Variations in performance can be realized due to physical changes in the printed circuit board and the application. Therefore, the designer should know that component value changes may be required in order to optimize performance in a given application. The values shown in this document can be used as a starting point for evaluation purposes. When working with high bandwidth circuits, good layout practices are also critical to achieving maximum performance.

IMPORTANT INFORMATION

The LM2423 performance is targeted for the HDTV market. The application circuits shown in this document to optimize performance and to protect against damage from CRT arc over are designed specifically for the LM2423. If another member of the LM242X family is used, please refer to its datasheet.

POWER SUPPLY BYPASS

Since the LM2423 is a wide bandwidth amplifier, proper power supply bypassing is critical for optimum performance. Improper power supply bypassing can result in large overshoot, ringing or oscillation. 0.1 μ F capacitors should be connected from the supply pins, V_{CC} and V_{BB} , to ground, as close to the LM2423 as is practical. Additionally, a 22 μ F or larger electrolytic capacitor should be connected from both supply pins to ground reasonably close to the LM2423.

ARC PROTECTION

During normal CRT operation, internal arcing may occasionally occur. This fast, high voltage, high-energy pulse can damage the LM2423 output stage. The application circuit shown in [Figure 13](#) is designed to help clamp the voltage at the output of the LM2423 to a safe level. The clamp diodes, D1 and D2, should have a fast transient response, high peak current rating, low series impedance and low shunt capacitance. 1SS83 or equivalent diodes are recommended. D1 and D2 should have short, low impedance connections to V_{CC} and ground respectively. The cathode of D1 should be located very close to a separately decoupled bypass capacitor (C3 in [Figure 13](#)). The ground connection of D2 and the decoupling capacitor should be very close to the LM2423 ground. This will significantly reduce the high frequency voltage transients that the LM2423 would be subjected to during an arc over condition. Resistor R2 limits the arc over current that is seen by the diodes while R1 limits the current into the LM2423 as well as the voltage stress at the outputs of the device. R2 should be a $\frac{1}{2}$ W solid carbon type resistor. R1 can be a $\frac{1}{4}$ W metal or carbon film type resistor. Having large value resistors for R1 and R2 would be desirable, but this has the effect of increasing rise and fall times. Inductor L1 is critical to reduce the initial high frequency voltage levels that the LM2423 would be subjected to. The inductor will not only help protect the device but it will also help minimize rise and fall times as well as minimize EMI. For proper arc protection, it is important to not omit any of the arc protection components shown in [Figure 13](#).

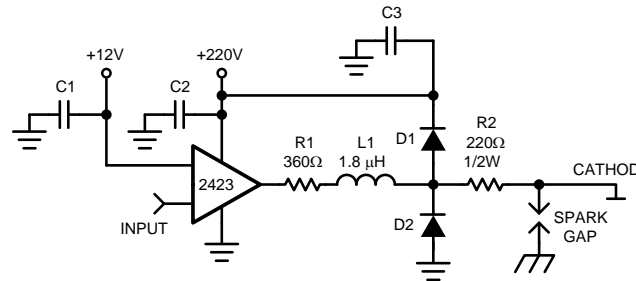

Figure 13. One Channel of the LM2423 with the Recommended Application Circuit

EFFECT OF LOAD CAPACITANCE

Figure 7 shows the effect of increased load capacitance on the speed of the device. This demonstrates the importance of knowing the load capacitance in the application. Increasing the load capacitance from 10 pF to 20 pF adds about 7 ns to both the rise and fall times. It is important to keep the board capacitance as low as possible to maximize the speed of the driver.

EFFECT OF OFFSET

Figure 8 shows the variation in rise and fall times when the output offset of the device is varied from 120V to 130V_{DC}. The rise and fall times both show a variation of about 6% relative to the center data point (125V_{DC}). The rise time increases in speed with the increase in offset voltage and the fall time decreased in speed with the increase in offset voltage.

THERMAL CONSIDERATIONS

Figure 9 shows the performance of the LM2423 in the test circuit shown in Figure 3 as a function of case temperature. The figure shows that both the rise and fall times of the LM2423 increase by approximately 14% as the case temperature increases from 30°C to 110°C. This corresponds to a speed degradation of 1.4% for every 10°C rise in case temperature.

Figure 10 shows the maximum power dissipation of the LM2423 vs. Frequency when all three channels of the device are driving into a 10 pF load with a 130V_{P-P} alternating one pixel on, one pixel off. The graph assumes a 72% active time (device operating at the specified frequency), which is typical in a TV application. The other 28% of the time the device is assumed to be sitting at the black level (190V in this case). This graph gives the designer the information needed to determine the heat sink requirement for his application. The designer should note that if the load capacitance is increased the AC component of the total power dissipation would also increase.

The LM2423 case temperature must be maintained below 110°C. If the maximum expected ambient temperature is 60°C and the maximum power dissipation is 17W (from Figure 10, 15 MHz) then a maximum heat sink thermal resistance can be calculated:

$$R_{TH} \frac{110^{\circ}\text{C} - 60^{\circ}\text{C}}{16.9} = 3.0^{\circ}\text{C/W} \quad (1)$$

This example assumes a capacitive load of 10 pF and no resistive load. The designer should note that if the load capacitance is increased the AC component of the total power dissipation will also increase.

OPTIMIZING TRANSIENT RESPONSE

Referring to Figure 13, there are three components (R1, R2 and L1) that can be adjusted to optimize the transient response of the application circuit. Increasing the values of R1 and R2 will slow the circuit down while decreasing overshoot. Increasing the value of L1 will speed up the circuit as well as increase overshoot. It is very important to use inductors with very high self-resonant frequencies, preferably above 300 MHz. Ferrite core inductors from J.W. Miller Magnetics (part # 78FR--K) were used for optimizing the performance of the device in

the TI application board. The values shown in [Figure 13](#) can be used as a good starting point for the evaluation of the LM2423. Using a variable resistor for R1 will simplify finding the value needed for optimum performance in a given application. Once the optimum value is determined the variable resistor can be replaced with a fixed value. Due to arc over considerations it is recommended that the values shown in [Figure 13](#) not be changed by a large amount.

[Figure 12](#) shows the typical cathode pulse response with an output swing of 130V_{PP} inside a modified Sony TV using a Sony pre-amp.

PC BOARD LAYOUT CONSIDERATIONS

For optimum performance, an adequate ground plane, isolation between channels, good supply bypassing and minimizing unwanted feedback are necessary. Also, the length of the signal traces from the signal inputs to the LM2423 and from the LM2423 to the CRT cathode should be as short as possible. The following references are recommended:

Ott, Henry W., "Noise Reduction Techniques in Electronic Systems", John Wiley & Sons, New York, 1976.

"Video Amplifier Design for Computer Monitors", Application Note [AN-1013](#).

Pease, Robert A., "Troubleshooting Analog Circuits", Butterworth-Heinemann, 1991.

Because of its high small signal bandwidth, the part may oscillate in a TV if feedback occurs around the video channel through the chassis wiring. To prevent this, leads to the video amplifier input circuit should be shielded, and input circuit wiring should be spaced as far as possible from output circuit wiring.

TYPICAL APPLICATION

A typical application of the LM2423 is shown in the schematic for the TI demonstration board in [Figure 14](#). Used in conjunction with an LM1246 preamplifier, a complete video channel from input to CRT cathode can be achieved. Performance is ideal for DTV applications. The TI demonstration board can be used to evaluate the LM2423 combination with the LM2485 and the LM1246 in a TV.

It is important that the TV designer use component values for the driver output stage close to the values shown in [Figure 14](#). These values have been selected to protect the LM2423 from arc over. Diodes D1, D2, D4, and D7–D9 must also be used for proper arc over protection. The TI demonstration board can be used to evaluate the LM2423 in a TV. If the TI demonstration board is used for evaluating the LM2423, then U3, the +5V voltage regulator may be used, eliminating the need to route +5V to the neck board for the LM1246.

TI DEMONSTRATION BOARD

[Figure 15](#) shows the routing and component placement on the TI LM2423/LM1246/LM2486 demonstration board. This board provides a good example of a layout that can be used as a guide for future layouts. Note the location of the following components:

- C19—V_{CC} bypass capacitor, located very close to pin 2 and ground pins
- C20—V_{BB} bypass capacitor, located close to pin 11 and ground
- C46, C48—V_{CC} bypass capacitors, near LM2423 and V_{CC} clamp diodes. Very important for arc protection.

The routing of the LM2423 outputs to the CRT is very critical to achieving optimum performance. [Figure 16](#) shows the routing and component placement from pin 10 (V_{OUT1}) of the LM2423 to the blue cathode. Note that the components are placed so that they almost line up from the output pin of the LM2423 to the blue cathode pin of the CRT connector. This is done to minimize the length of the video path between these two components. Note also that D8, D9, R24, and D6 are placed to minimize the size of the video nodes that they are attached to. This minimizes parasitic capacitance in the video path and also enhances the effectiveness of the protection diodes. The anode of protection diode D8 is connected directly to a section of the ground plane that has a short and direct path to the LM2423 ground pins. The cathode of D9 is connected to V_{CC} very close to decoupling capacitor C7 which is connected to the same area of the ground trace as D8. The diode placement and routing is very important for minimizing the voltage stress on the LM2423 during an arc over event.

This demonstration board uses large PCB holes to accommodate socket pins, which function to allow for multiple insertions of the LM2423 in a convenient manner. To benefit from the enhanced LM2423 package with thin leads, the device should be secured in small PCB holes to optimize the metal-to-metal spacing between the leads.

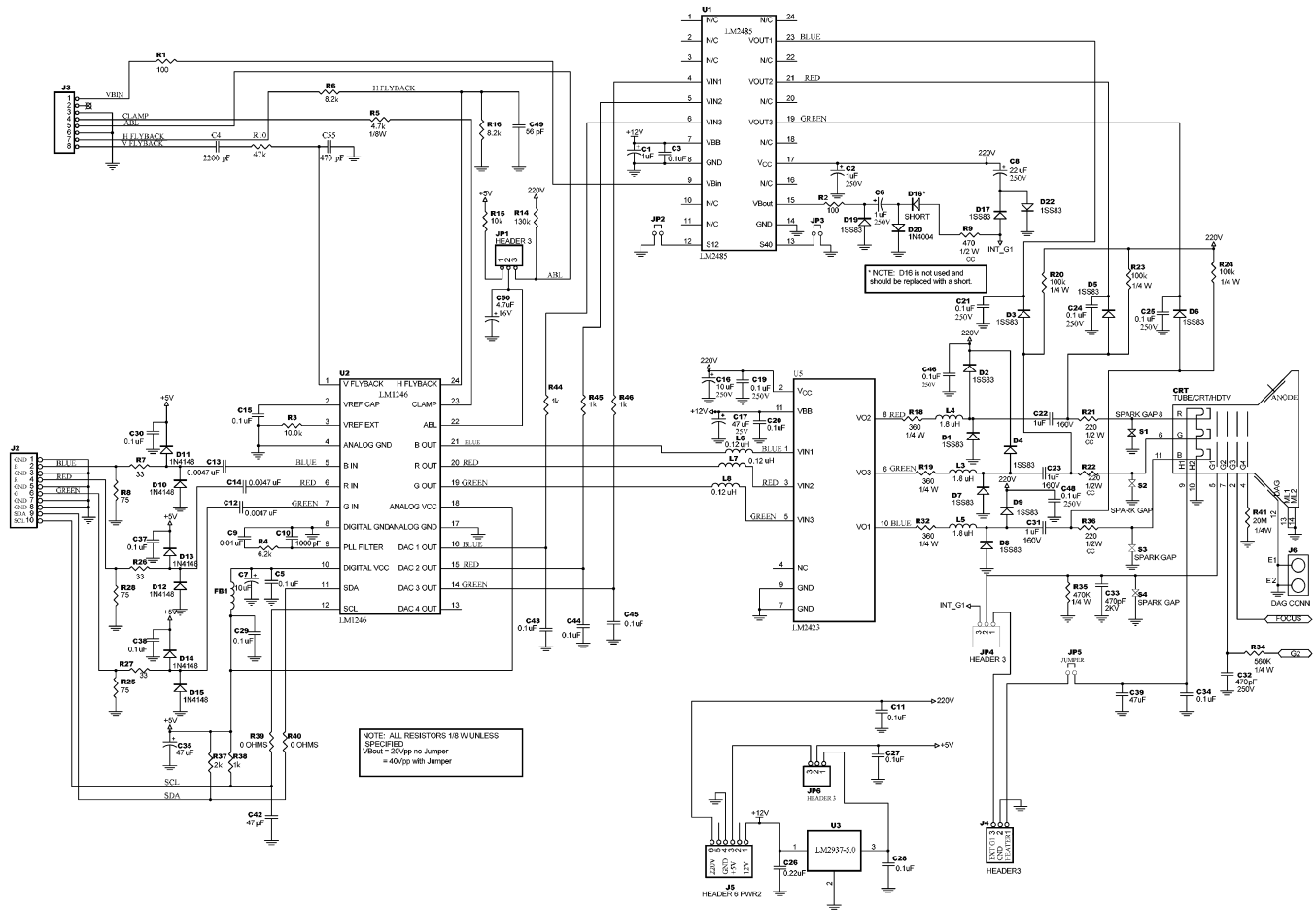

Figure 14. LM2423/LM1246/LM2485 DTV Applications Circuit

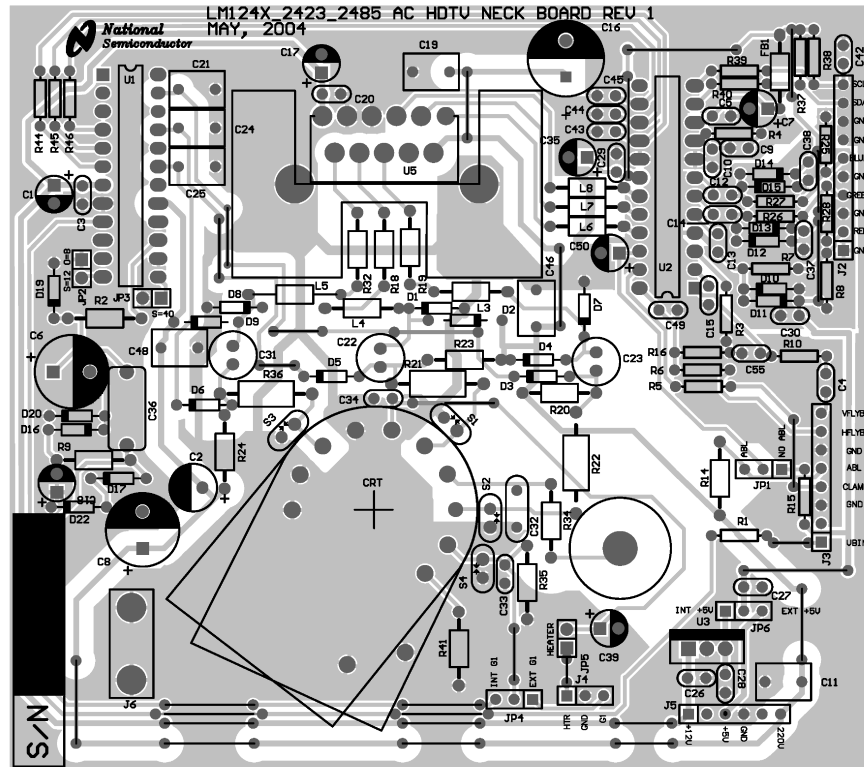

Figure 15. LM2423/LM1246/LM2485 DTV Demonstration Board Layout

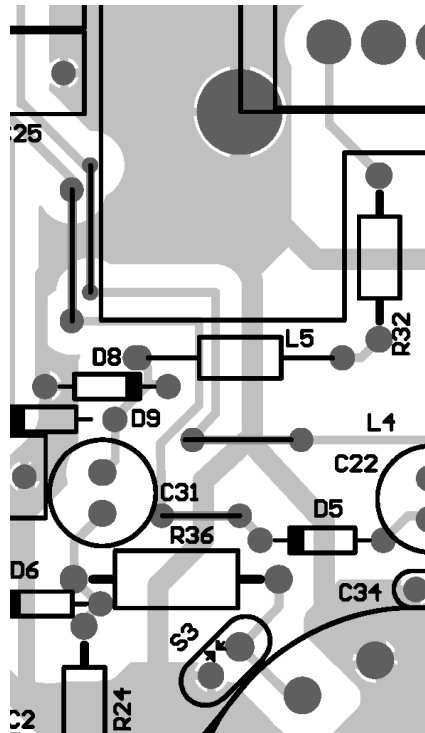

Figure 16. Trace Routing and Component Placement for Blue Channel Output

REVISION HISTORY

Changes from Revision A (April 2013) to Revision B	Page
<hr/> <ul style="list-style-type: none">• Changed layout of National Data Sheet to TI format	<hr/> 10

IMPORTANT NOTICE

Texas Instruments Incorporated and its subsidiaries (TI) reserve the right to make corrections, enhancements, improvements and other changes to its semiconductor products and services per JESD46, latest issue, and to discontinue any product or service per JESD48, latest issue. Buyers should obtain the latest relevant information before placing orders and should verify that such information is current and complete. All semiconductor products (also referred to herein as "components") are sold subject to TI's terms and conditions of sale supplied at the time of order acknowledgment.

TI warrants performance of its components to the specifications applicable at the time of sale, in accordance with the warranty in TI's terms and conditions of sale of semiconductor products. Testing and other quality control techniques are used to the extent TI deems necessary to support this warranty. Except where mandated by applicable law, testing of all parameters of each component is not necessarily performed.

TI assumes no liability for applications assistance or the design of Buyers' products. Buyers are responsible for their products and applications using TI components. To minimize the risks associated with Buyers' products and applications, Buyers should provide adequate design and operating safeguards.

TI does not warrant or represent that any license, either express or implied, is granted under any patent right, copyright, mask work right, or other intellectual property right relating to any combination, machine, or process in which TI components or services are used. Information published by TI regarding third-party products or services does not constitute a license to use such products or services or a warranty or endorsement thereof. Use of such information may require a license from a third party under the patents or other intellectual property of the third party, or a license from TI under the patents or other intellectual property of TI.

Reproduction of significant portions of TI information in TI data books or data sheets is permissible only if reproduction is without alteration and is accompanied by all associated warranties, conditions, limitations, and notices. TI is not responsible or liable for such altered documentation. Information of third parties may be subject to additional restrictions.

Resale of TI components or services with statements different from or beyond the parameters stated by TI for that component or service voids all express and any implied warranties for the associated TI component or service and is an unfair and deceptive business practice. TI is not responsible or liable for any such statements.

Buyer acknowledges and agrees that it is solely responsible for compliance with all legal, regulatory and safety-related requirements concerning its products, and any use of TI components in its applications, notwithstanding any applications-related information or support that may be provided by TI. Buyer represents and agrees that it has all the necessary expertise to create and implement safeguards which anticipate dangerous consequences of failures, monitor failures and their consequences, lessen the likelihood of failures that might cause harm and take appropriate remedial actions. Buyer will fully indemnify TI and its representatives against any damages arising out of the use of any TI components in safety-critical applications.

In some cases, TI components may be promoted specifically to facilitate safety-related applications. With such components, TI's goal is to help enable customers to design and create their own end-product solutions that meet applicable functional safety standards and requirements. Nonetheless, such components are subject to these terms.

No TI components are authorized for use in FDA Class III (or similar life-critical medical equipment) unless authorized officers of the parties have executed a special agreement specifically governing such use.

Only those TI components which TI has specifically designated as military grade or "enhanced plastic" are designed and intended for use in military/aerospace applications or environments. Buyer acknowledges and agrees that any military or aerospace use of TI components which have **not** been so designated is solely at the Buyer's risk, and that Buyer is solely responsible for compliance with all legal and regulatory requirements in connection with such use.

TI has specifically designated certain components as meeting ISO/TS16949 requirements, mainly for automotive use. In any case of use of non-designated products, TI will not be responsible for any failure to meet ISO/TS16949.

Products

Audio	www.ti.com/audio
Amplifiers	amplifier.ti.com
Data Converters	dataconverter.ti.com
DLP® Products	www.dlp.com
DSP	dsp.ti.com
Clocks and Timers	www.ti.com/clocks
Interface	interface.ti.com
Logic	logic.ti.com
Power Mgmt	power.ti.com
Microcontrollers	microcontroller.ti.com
RFID	www.ti-rfid.com
OMAP Applications Processors	www.ti.com/omap
Wireless Connectivity	www.ti.com/wirelessconnectivity

Applications

Automotive and Transportation	www.ti.com/automotive
Communications and Telecom	www.ti.com/communications
Computers and Peripherals	www.ti.com/computers
Consumer Electronics	www.ti.com/consumer-apps
Energy and Lighting	www.ti.com/energy
Industrial	www.ti.com/industrial
Medical	www.ti.com/medical
Security	www.ti.com/security
Space, Avionics and Defense	www.ti.com/space-avionics-defense
Video and Imaging	www.ti.com/video

TI E2E Community

e2e.ti.com