

# DS7820

*DS7820 Dual Line Receiver*



Literature Number: SNOSBL2

## DS7820 Dual Line Receiver

### General Description

The DS7820, specified from  $-55^{\circ}\text{C}$  to  $+125^{\circ}\text{C}$ , is a digital line receiver with two completely independent units fabricated on a single silicon chip. Intended for use with digital systems connected by twisted pair lines, they have a differential input designed to reject large common mode signals while responding to small differential signals. The output is directly compatible with TTL or LS integrated circuits.

The response time can be controlled with an external capacitor to eliminate noise spikes, and the output state is determined for open inputs. Termination resistors for the twisted pair line are also included in the circuit. The DS7820 is speci-

fied, worst case, over the full operating temperature range, for  $\pm 10$ -percent supply voltage variations and over the entire input voltage range.

### Features

- Operation from a single +5V logic supply
- Input voltage range of  $\pm 15\text{V}$
- Each channel can be strobed independently
- High input resistance
- Fan out of two with TTL integrated circuits
- Strobe low forces output to "1" state

### Connection Diagram

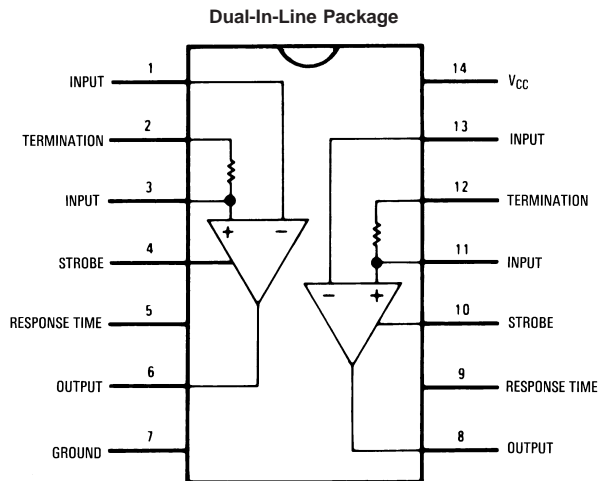

DS005796-2

#### Top View

For Complete Military 883 Specifications, See RETS Data Sheet.  
Order Number: DS7820J/883  
See NS Package Number J14A

## Absolute Maximum Ratings (Note 2)

If Military/Aerospace specified devices are required, please contact the National Semiconductor Sales Office/Distributors for availability and specifications.

Supply Voltage	8.0V
Input Voltage	±20V
Differential Input Voltage	±20V
Strobe Voltage	8.0V
Output Sink Current	25 mA

Storage Temperature Range	-65°C to +150°C
Lead Temperature (Soldering, 4 sec.)	260°C
Maximum Power Dissipation at 25°C (Note 1)	1308 mW

## Operating Conditions

	Min	Max	Units
Supply Voltage ( $V_{CC}$ )	4.5	5.5	V
Temperature ( $T_A$ )	-55	+125	°C

## Electrical Characteristics (Notes 3, 4)

Symbol	Parameter	Conditions	Min	Typ	Max	Units
$V_{TH}$	Input Threshold Voltage	$V_{CM} = 0V$	-0.5	0	0.5	V
		$-15V \leq V_{CM} \leq 15V$	-1.0	0	1.0	V
$V_{OH}$	High Output Level	$I_{OUT} \leq 0.2 \text{ mA}$	2.5		5.5	V
$V_{OL}$	Low Output Level	$I_{SINK} \leq 3.5 \text{ mA}$	0		0.4	V
$R_{I^-}$	Inverting Input Resistance		3.6	5.0		k $\Omega$
$R_{I^+}$	Non-Inverting Input Resistance		1.8	2.5		k $\Omega$
$R_T$	Line Termination Resistance	$T_A = 25^\circ\text{C}$	120	170	250	$\Omega$
$t_r$	Response Time	$C_{DELAY} = 0 \text{ pF}$		40		ns
		$C_{DELAY} = 100 \text{ pF}$		150		ns
$I_{ST}$	Strobe Current	$V_{STROBE} = 0.4V$		-1.0	-1.4	mA
		$V_{STROBE} = 5.5V$			5.0	$\mu\text{A}$
$I_{CC}$	Power Supply Current	$V_{IN} = 15V$		3.2	6.0	mA
		$V_{IN} = 0V$		5.8	10.2	mA
		$V_{IN} = -15V$		8.3	15.0	mA
$I_{IN^+}$	Non-Inverting Input Current	$V_{IN} = 15V$		5.0	7.0	mA
		$V_{IN} = 0V$	-1.6	-1.0		mA
		$V_{IN} = -15V$	-9.8	-7.0		mA
$I_{IN^-}$	Inverting Input Current	$V_{IN} = 15V$		3.0	4.2	mA
		$V_{IN} = 0V$		0	-0.5	mA
		$V_{IN} = -15V$	-4.2	-3.0		mA

**Note 1:** Derate cavity package 8.7 mW/°C above 25°C.

**Note 2:** "Absolute Maximum Ratings" are those values beyond which the safety of the device cannot be guaranteed. Except for "Operating Temperature Range" they are not meant to imply that the devices should be operated at these limits. The table of "Electrical Characteristics" provides conditions for actual device operation.

**Note 3:** These specifications apply for  $4.5V \leq V_{CC} \leq 5.5V$ ,  $-15V \leq V_{CM} \leq 15V$  and  $-55^\circ\text{C} \leq T_A \leq +125^\circ\text{C}$  unless otherwise specified; typical values given are for  $V_{CC} = 5.0V$ ,  $T_A = 25^\circ\text{C}$  and  $V_{CM} = 0$  unless stated differently.

**Note 4:** All currents into device pins shown as positive, out of device pins as negative, all voltages referenced to ground unless otherwise noted. All values shown as max or min on absolute value basis.

**Note 5:** The specifications and curves given are for one side only. Therefore, the total package dissipation and supply currents will be double the values given when both receivers are operated under identical conditions.

# Typical Performance Characteristics (Note 4)

**Supply Voltage Sensitivity**

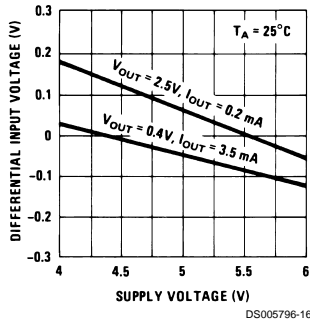

**Common Mode Rejection**

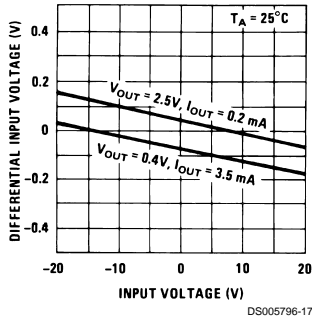

**Transfer Function**

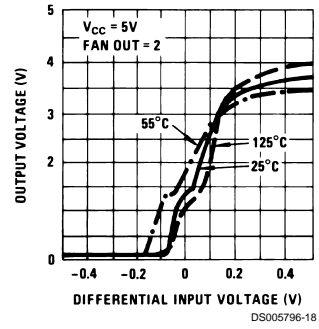

**Response Time**

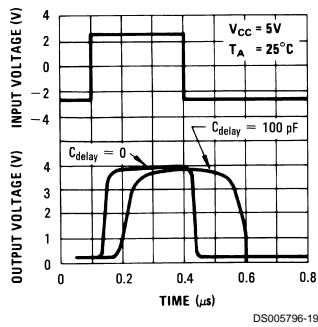

**Output Voltage Levels**

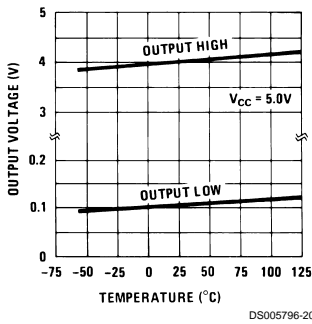

**Termination Resistance**

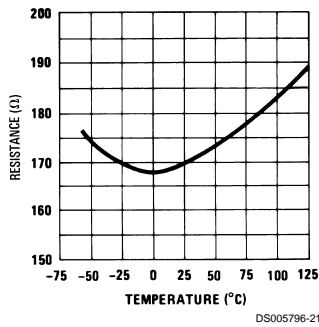

**Positive Supply Current**

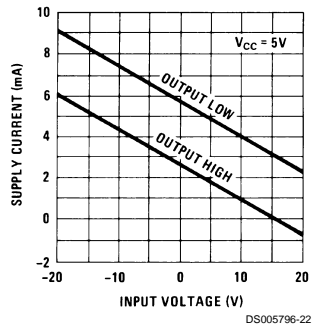

**Internal Power Dissipation**

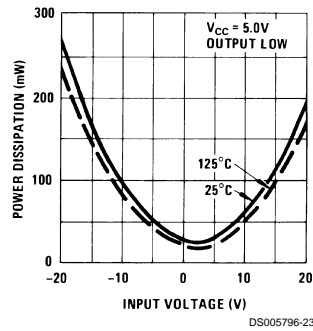

## Typical Application

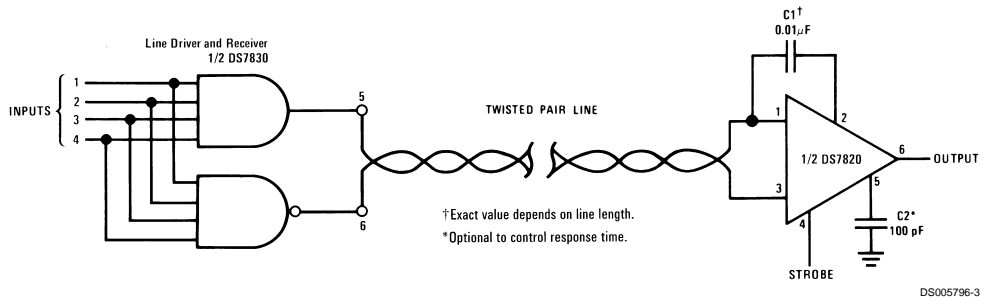

## Schematic Diagram

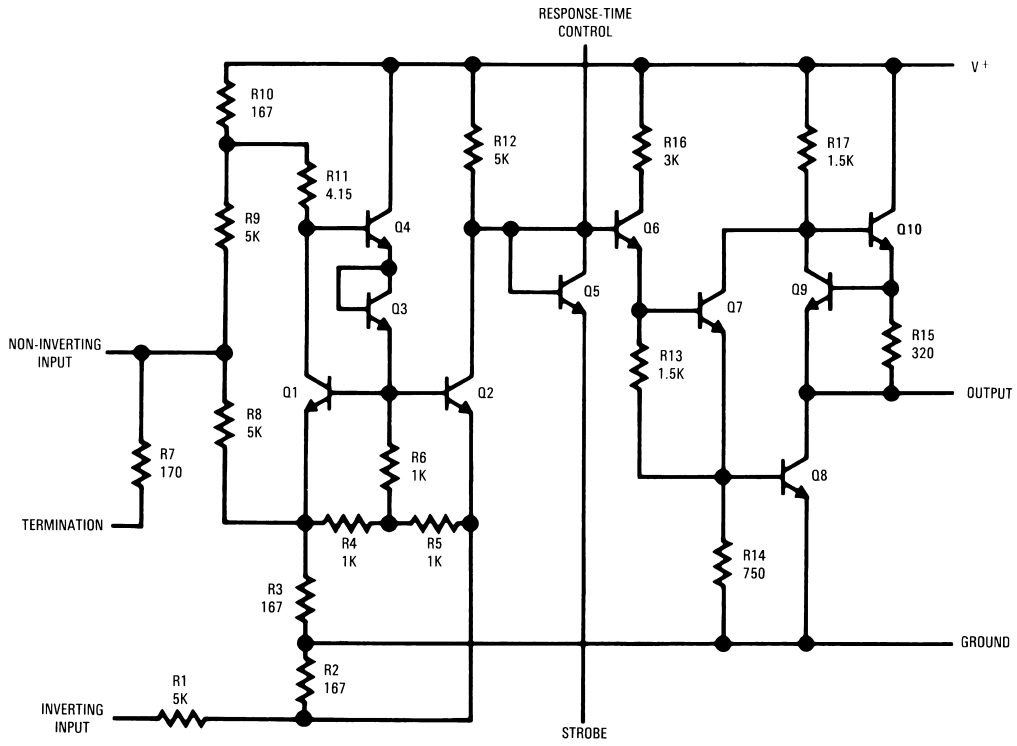

**Physical Dimensions** inches (millimeters) unless otherwise noted

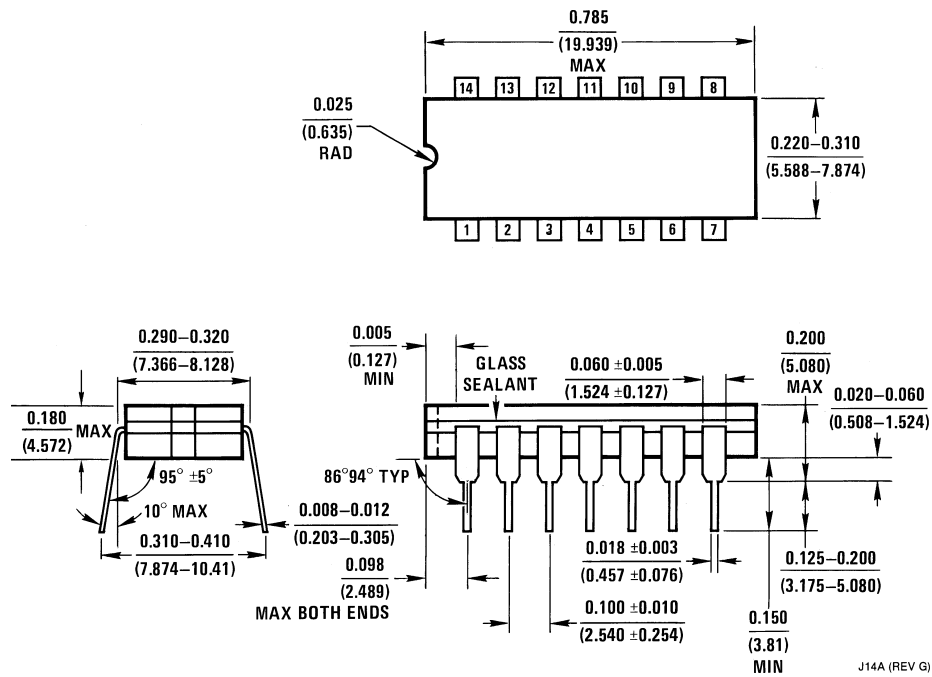

**Ceramic Dual-In-Line Package (J)**  
**Order Number DS7820J/883**  
**NS Package Number J14A**

**LIFE SUPPORT POLICY**

NATIONAL'S PRODUCTS ARE NOT AUTHORIZED FOR USE AS CRITICAL COMPONENTS IN LIFE SUPPORT DEVICES OR SYSTEMS WITHOUT THE EXPRESS WRITTEN APPROVAL OF THE PRESIDENT AND GENERAL COUNSEL OF NATIONAL SEMICONDUCTOR CORPORATION. As used herein:

1. Life support devices or systems are devices or systems which, (a) are intended for surgical implant into the body, or (b) support or sustain life, and whose failure to perform when properly used in accordance with instructions for use provided in the labeling, can be reasonably expected to result in a significant injury to the user.
2. A critical component is any component of a life support device or system whose failure to perform can be reasonably expected to cause the failure of the life support device or system, or to affect its safety or effectiveness.

**National Semiconductor Corporation**  
 Americas  
 Tel: 1-800-272-9959  
 Fax: 1-800-737-7018  
 Email: support@nsc.com  
 www.national.com

**National Semiconductor Europe**  
 Fax: +49 (0) 1 80-530 85 86  
 Email: europe.support@nsc.com  
 Deutsch Tel: +49 (0) 1 80-530 85 85  
 English Tel: +49 (0) 1 80-532 78 32  
 Français Tel: +49 (0) 1 80-532 93 58  
 Italiano Tel: +49 (0) 1 80-534 16 80

**National Semiconductor Asia Pacific Customer Response Group**  
 Tel: 65-2544466  
 Fax: 65-2504466  
 Email: sea.support@nsc.com

**National Semiconductor Japan Ltd.**  
 Tel: 81-3-5639-7560  
 Fax: 81-3-5639-7507

National does not assume any responsibility for use of any circuitry described, no circuit patent licenses are implied and National reserves the right at any time without notice to change said circuitry and specifications.

## IMPORTANT NOTICE

Texas Instruments Incorporated and its subsidiaries (TI) reserve the right to make corrections, modifications, enhancements, improvements, and other changes to its products and services at any time and to discontinue any product or service without notice. Customers should obtain the latest relevant information before placing orders and should verify that such information is current and complete. All products are sold subject to TI's terms and conditions of sale supplied at the time of order acknowledgment.

TI warrants performance of its hardware products to the specifications applicable at the time of sale in accordance with TI's standard warranty. Testing and other quality control techniques are used to the extent TI deems necessary to support this warranty. Except where mandated by government requirements, testing of all parameters of each product is not necessarily performed.

TI assumes no liability for applications assistance or customer product design. Customers are responsible for their products and applications using TI components. To minimize the risks associated with customer products and applications, customers should provide adequate design and operating safeguards.

TI does not warrant or represent that any license, either express or implied, is granted under any TI patent right, copyright, mask work right, or other TI intellectual property right relating to any combination, machine, or process in which TI products or services are used. Information published by TI regarding third-party products or services does not constitute a license from TI to use such products or services or a warranty or endorsement thereof. Use of such information may require a license from a third party under the patents or other intellectual property of the third party, or a license from TI under the patents or other intellectual property of TI.

Reproduction of TI information in TI data books or data sheets is permissible only if reproduction is without alteration and is accompanied by all associated warranties, conditions, limitations, and notices. Reproduction of this information with alteration is an unfair and deceptive business practice. TI is not responsible or liable for such altered documentation. Information of third parties may be subject to additional restrictions.

Resale of TI products or services with statements different from or beyond the parameters stated by TI for that product or service voids all express and any implied warranties for the associated TI product or service and is an unfair and deceptive business practice. TI is not responsible or liable for any such statements.

TI products are not authorized for use in safety-critical applications (such as life support) where a failure of the TI product would reasonably be expected to cause severe personal injury or death, unless officers of the parties have executed an agreement specifically governing such use. Buyers represent that they have all necessary expertise in the safety and regulatory ramifications of their applications, and acknowledge and agree that they are solely responsible for all legal, regulatory and safety-related requirements concerning their products and any use of TI products in such safety-critical applications, notwithstanding any applications-related information or support that may be provided by TI. Further, Buyers must fully indemnify TI and its representatives against any damages arising out of the use of TI products in such safety-critical applications.

TI products are neither designed nor intended for use in military/aerospace applications or environments unless the TI products are specifically designated by TI as military-grade or "enhanced plastic." Only products designated by TI as military-grade meet military specifications. Buyers acknowledge and agree that any such use of TI products which TI has not designated as military-grade is solely at the Buyer's risk, and that they are solely responsible for compliance with all legal and regulatory requirements in connection with such use.

TI products are neither designed nor intended for use in automotive applications or environments unless the specific TI products are designated by TI as compliant with ISO/TS 16949 requirements. Buyers acknowledge and agree that, if they use any non-designated products in automotive applications, TI will not be responsible for any failure to meet such requirements.

Following are URLs where you can obtain information on other Texas Instruments products and application solutions:

### Products

Audio	<a href="http://www.ti.com/audio">www.ti.com/audio</a>
Amplifiers	<a href="http://amplifier.ti.com">amplifier.ti.com</a>
Data Converters	<a href="http://dataconverter.ti.com">dataconverter.ti.com</a>
DLP® Products	<a href="http://www.dlp.com">www.dlp.com</a>
DSP	<a href="http://dsp.ti.com">dsp.ti.com</a>
Clocks and Timers	<a href="http://www.ti.com/clocks">www.ti.com/clocks</a>
Interface	<a href="http://interface.ti.com">interface.ti.com</a>
Logic	<a href="http://logic.ti.com">logic.ti.com</a>
Power Mgmt	<a href="http://power.ti.com">power.ti.com</a>
Microcontrollers	<a href="http://microcontroller.ti.com">microcontroller.ti.com</a>
RFID	<a href="http://www.ti-rfid.com">www.ti-rfid.com</a>
OMAP Mobile Processors	<a href="http://www.ti.com/omap">www.ti.com/omap</a>
Wireless Connectivity	<a href="http://www.ti.com/wirelessconnectivity">www.ti.com/wirelessconnectivity</a>

### Applications

Communications and Telecom	<a href="http://www.ti.com/communications">www.ti.com/communications</a>
Computers and Peripherals	<a href="http://www.ti.com/computers">www.ti.com/computers</a>
Consumer Electronics	<a href="http://www.ti.com/consumer-apps">www.ti.com/consumer-apps</a>
Energy and Lighting	<a href="http://www.ti.com/energy">www.ti.com/energy</a>
Industrial	<a href="http://www.ti.com/industrial">www.ti.com/industrial</a>
Medical	<a href="http://www.ti.com/medical">www.ti.com/medical</a>
Security	<a href="http://www.ti.com/security">www.ti.com/security</a>
Space, Avionics and Defense	<a href="http://www.ti.com/space-avionics-defense">www.ti.com/space-avionics-defense</a>
Transportation and Automotive	<a href="http://www.ti.com/automotive">www.ti.com/automotive</a>
Video and Imaging	<a href="http://www.ti.com/video">www.ti.com/video</a>

TI E2E Community Home Page

[e2e.ti.com](http://e2e.ti.com)

Mailing Address: Texas Instruments, Post Office Box 655303, Dallas, Texas 75265  
Copyright © 2011, Texas Instruments Incorporated