

LM565/LM565C Phase Locked Loop

Check for Samples: [LM565](#), [LM565C](#)

FEATURES

- 200 ppm/°C Frequency Stability of the VCO
- Power Supply Range of ± 5 to ± 12 Volts with 100 ppm/% Typical
- 0.2% Linearity of Demodulated Output
- Linear Triangle Wave with in Phase Zero Crossings Available
- TTL and DTL Compatible Phase Detector Input and Square Wave Output
- Adjustable Hold in Range from $\pm 1\%$ to $> \pm 60\%$

APPLICATIONS

- Data and Tape Zynchronization
- Modems
- FSK Demodulation
- FM Demodulation
- Frequency Synthesizer
- Tone Decoding
- Frequency Multiplication and Division
- SCA Demodulators
- Telemetry Receivers
- Signal Regeneration
- Coherent Demodulators

Connection Diagram

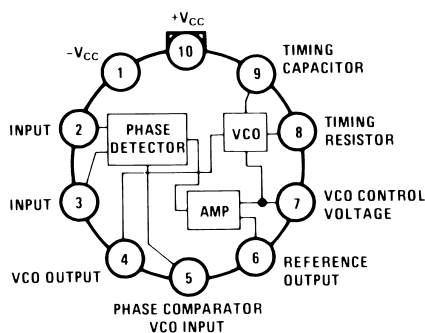

TO-100 Package
See Package Number LME

DESCRIPTION

The LM565 and LM565C are general purpose phase locked loops containing a stable, highly linear voltage controlled oscillator for low distortion FM demodulation, and a double balanced phase detector with good carrier suppression. The VCO frequency is set with an external resistor and capacitor, and a tuning range of 10:1 can be obtained with the same capacitor. The characteristics of the closed loop system—bandwidth, response speed, capture and pull in range—may be adjusted over a wide range with an external resistor and capacitor. The loop may be broken between the VCO and the phase detector for insertion of a digital frequency divider to obtain frequency multiplication.

The LM565H is specified for operation over the -55°C to $+125^{\circ}\text{C}$ military temperature range. The LM565CN is specified for operation over the 0°C to $+70^{\circ}\text{C}$ temperature range.



Please be aware that an important notice concerning availability, standard warranty, and use in critical applications of Texas Instruments semiconductor products and disclaimers thereto appears at the end of this data sheet.

All trademarks are the property of their respective owners.

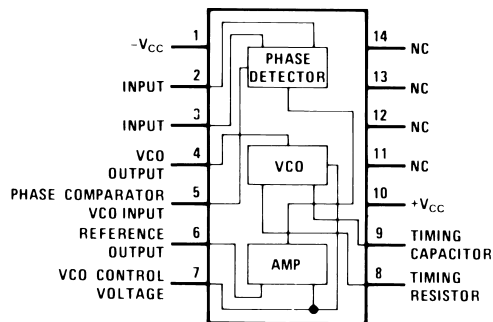

**Dual-in-Line Package
PDIP
See Package Number NFF**



These devices have limited built-in ESD protection. The leads should be shorted together or the device placed in conductive foam during storage or handling to prevent electrostatic damage to the MOS gates.

Absolute Maximum Ratings⁽¹⁾⁽²⁾

Supply Voltage		±12V
Power Dissipation ⁽³⁾		1400 mW
Differential Input Voltage		±1V
Operating Temperature Range	LM565H	-55°C to +125°C
	LM565CN	0°C to +70°C
Storage Temperature Range		-65°C to +150°C
Lead Temperature (Soldering, 10 sec.)		260°C

- (1) Absolute Maximum Ratings indicate limits beyond which damage to the device may occur. Operating Ratings indicate conditions for which the device is functional, but do not ensure specific performance limits. Electrical Characteristics state DC and AC electrical specifications under particular test conditions which ensure specific performance limits. This assumes that the device is within the Operating Ratings. Specifications are not ensured for parameters where no limit is given, however, the typical value is a good indication of device performance.
- (2) If Military/Aerospace specified devices are required, please contact the Texas Instruments Sales Office/ Distributors for availability and specifications.
- (3) The maximum junction temperature of the LM565 and LM565C is +150°C. For operation at elevated temperatures, devices in the TO-5 package must be derated based on a thermal resistance of +150°C/W junction to ambient or +45°C/W junction to case. Thermal resistance of the dual-in-line package is +85°C/W.

Electrical CharacteristicsAC Test Circuit, $T_A = 25^\circ\text{C}$, $V_{CC} = \pm 6\text{V}$

Parameter	Conditions	LM565			LM565C			Units
		Min	Typ	Max	Min	Typ	Max	
Power Supply Current			8.0	12.5		8.0	12.5	mA
Input Impedance (Pins 2, 3)	$-4\text{V} < V_2, V_3 < 0\text{V}$	7	10			5		k Ω
VCO Maximum Operating Frequency	$C_o = 2.7 \text{ pF}$	300	500		250	500		kHz
VCO Free-Running Frequency	$C_o = 1.5 \text{ nF}$ $R_o = 20 \text{ k}\Omega$ $f_o = 10 \text{ kHz}$	-10	0	+10	-30	0	+30	%
Operating Frequency Temperature Coefficient			-100			-200		ppm/°C
Frequency Drift with Supply Voltage			0.1	1.0		0.2	1.5	%/V
Triangle Wave Output Voltage		2	2.4	3	2	2.4	3	V_{p-p}
Triangle Wave Output Linearity			0.2			0.5		%
Square Wave Output Level		4.7	5.4		4.7	5.4		V_{p-p}
Output Impedance (Pin 4)			5			5		k Ω
Square Wave Duty Cycle		45	50	55	40	50	60	%
Square Wave Rise Time			20			20		ns
Square Wave Fall Time			50			50		ns
Output Current Sink (Pin 4)		0.6	1		0.6	1		mA
VCO Sensitivity	$f_o = 10 \text{ kHz}$		6600			6600		Hz/V
Demodulated Output Voltage (Pin 7)	±10% Frequency Deviation	250	300	400	200	300	450	mV_{p-p}
Total Harmonic Distortion	±10% Frequency Deviation		0.2	0.75		0.2	1.5	%
Output Impedance (Pin 7)			3.5			3.5		k Ω
DC Level (Pin 7)		4.25	4.5	4.75	4.0	4.5	5.0	V
Output Offset Voltage $ V_7 - V_6 $			30	100		50	200	mV
Temperature Drift of $ V_7 - V_6 $			500			500		$\mu\text{V}/^\circ\text{C}$
AM Rejection		30	40			40		dB
Phase Detector Sensitivity K_D			0.68			0.68		V/radian

Typical Performance Characteristics

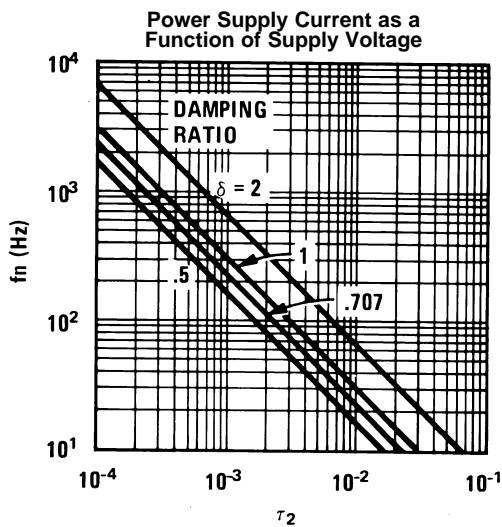

Figure 1.

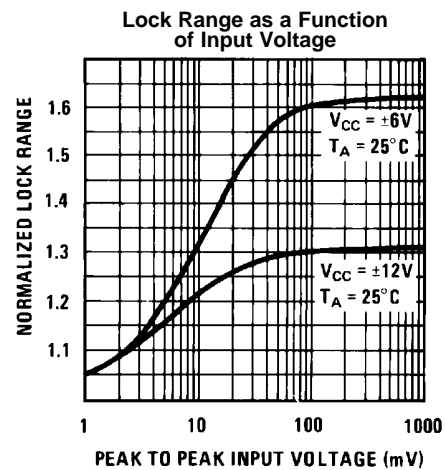

Figure 2.

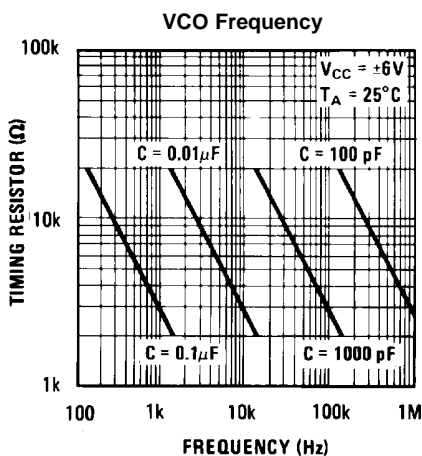

Figure 3.

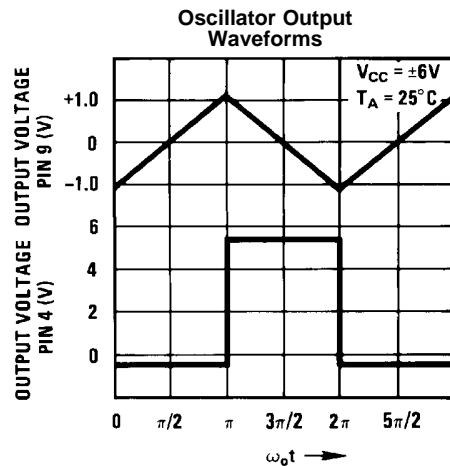

Figure 4.

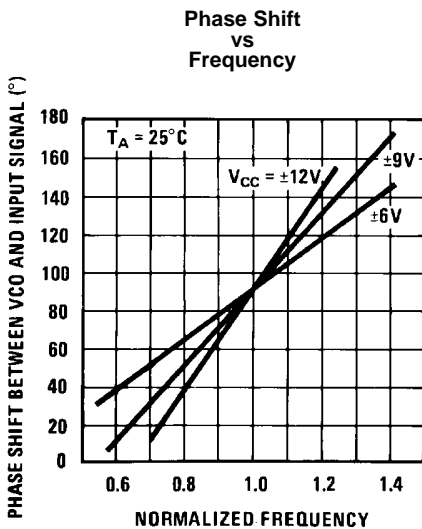

Figure 5.

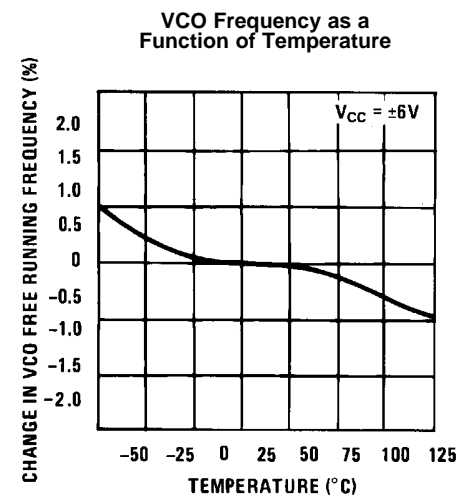
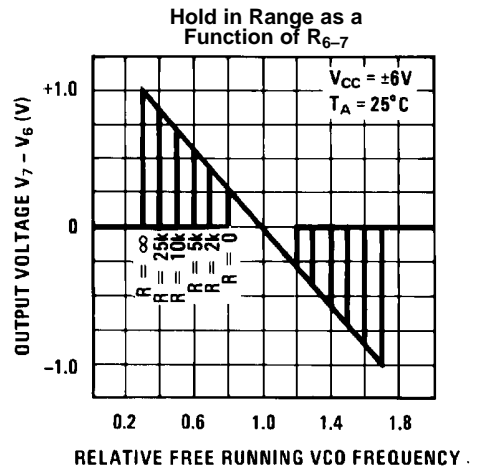
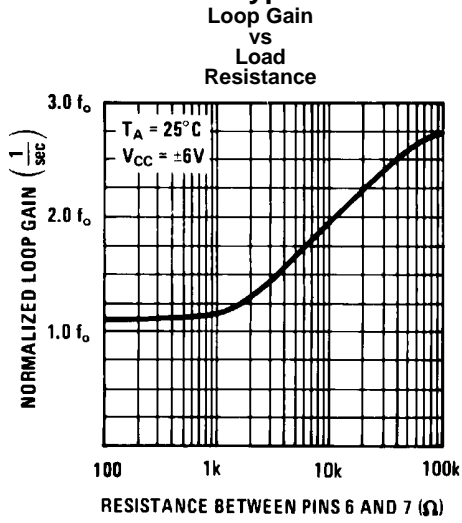

Figure 6.

Typical Performance Characteristics (continued)



Schematic Diagram

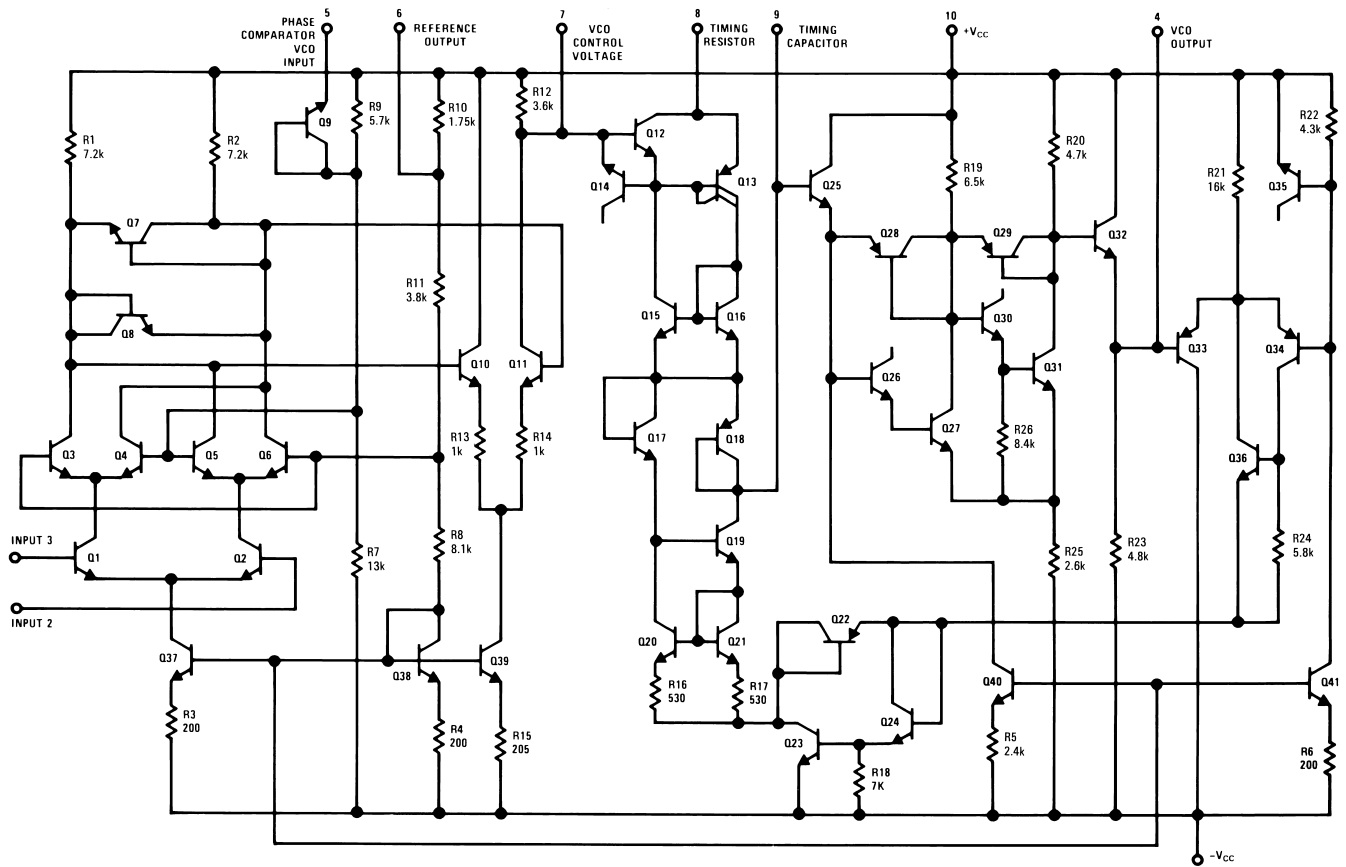
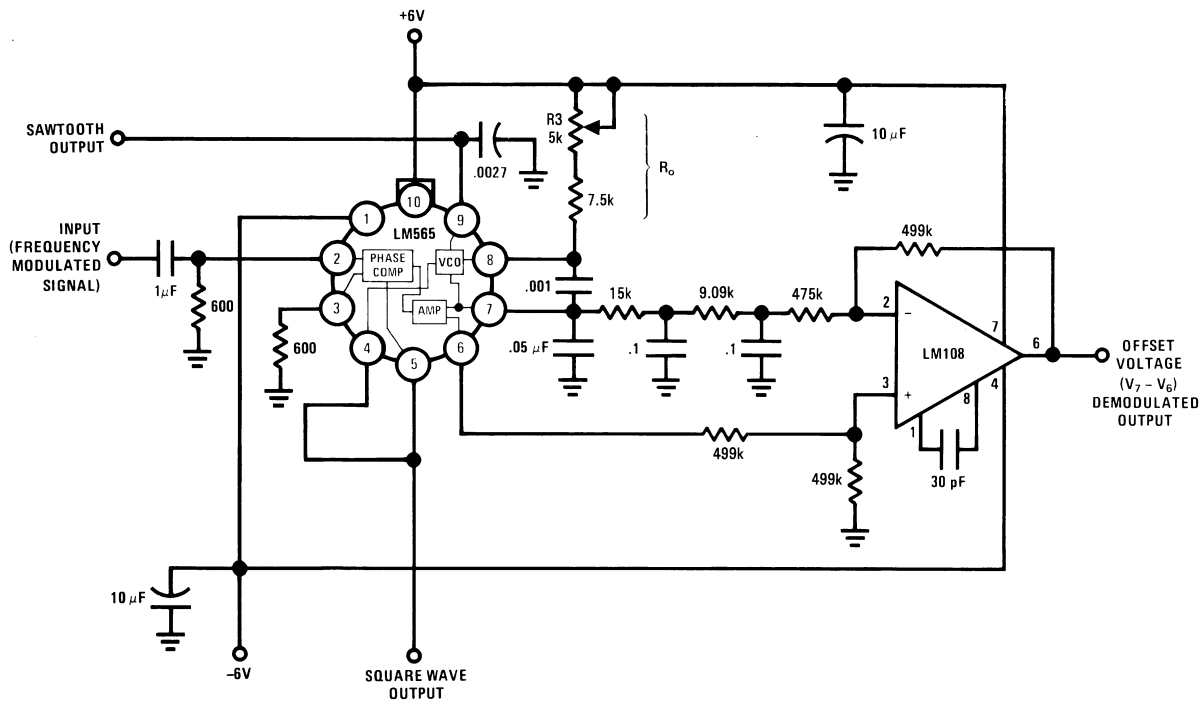

Figure 9. Schematic Diagram

AC Test Circuit



Note: S₁ open for output offset voltage ($V_7 - V_6$) measurement.

Figure 10. AC Test Circuit

Typical Applications

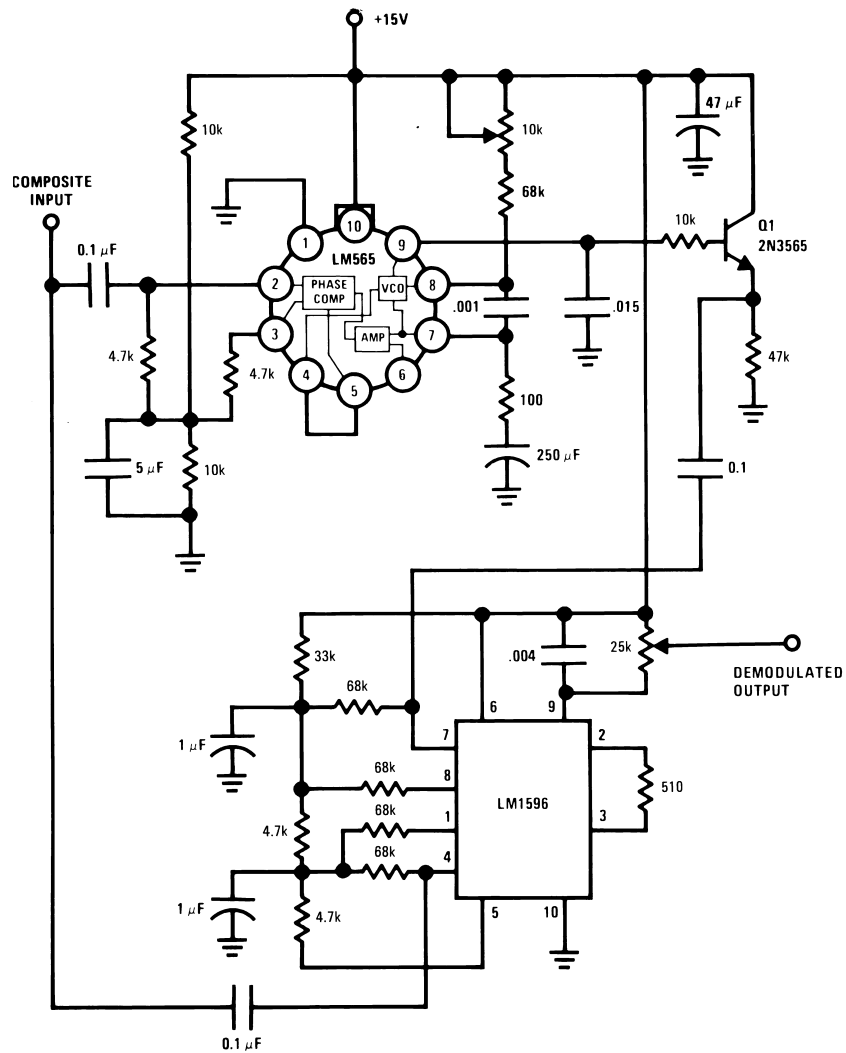

Figure 11. 2400 Hz Synchronous AM Demodulator

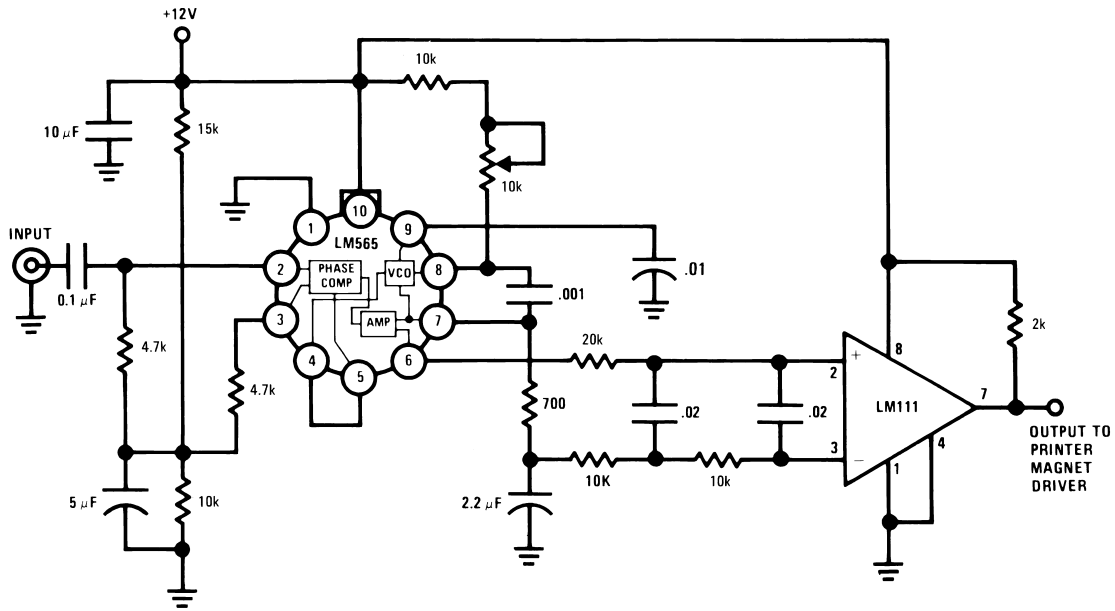

Figure 12. FSK Demodulator (2025–2225 cps)

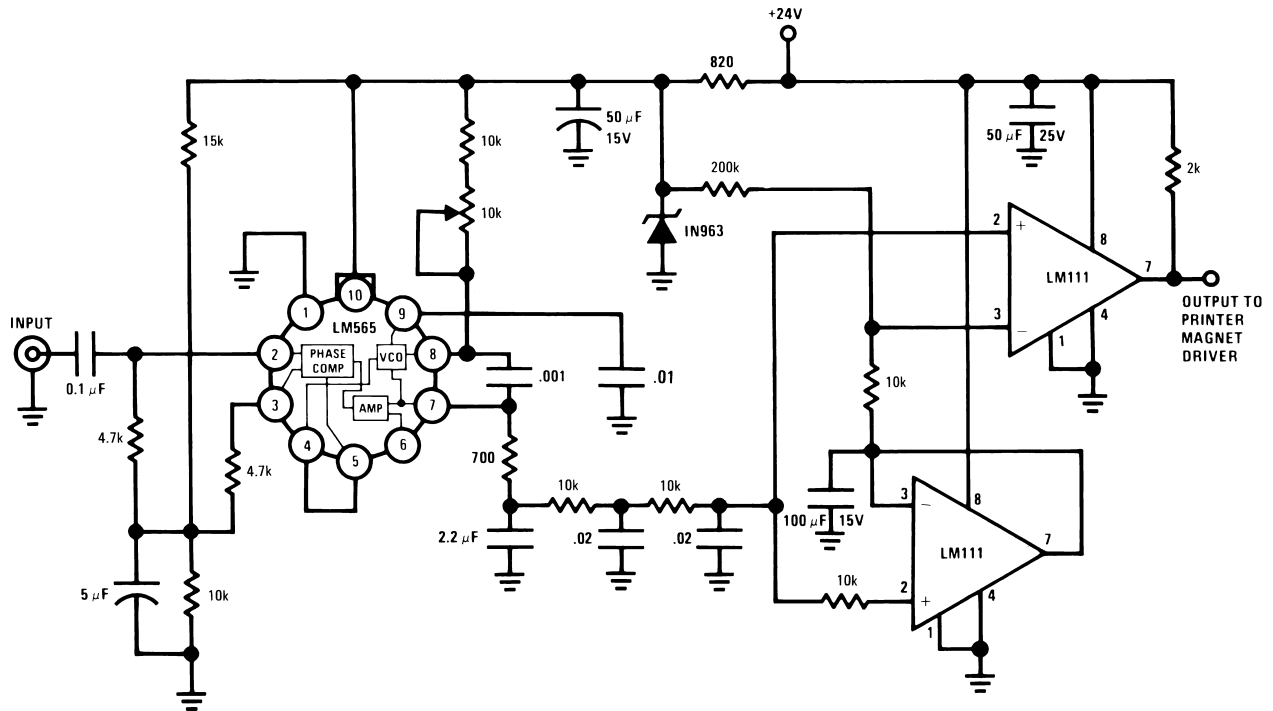

Figure 13. FSK Demodulator with DC Restoration

Figure 14. Frequency Multiplier ($\times 10$)

Figure 15. IRIG Channel 13 Demodulator

APPLICATIONS INFORMATION

In designing with phase locked loops such as the LM565, the important parameters of interest are:

FREE RUNNING FREQUENCY

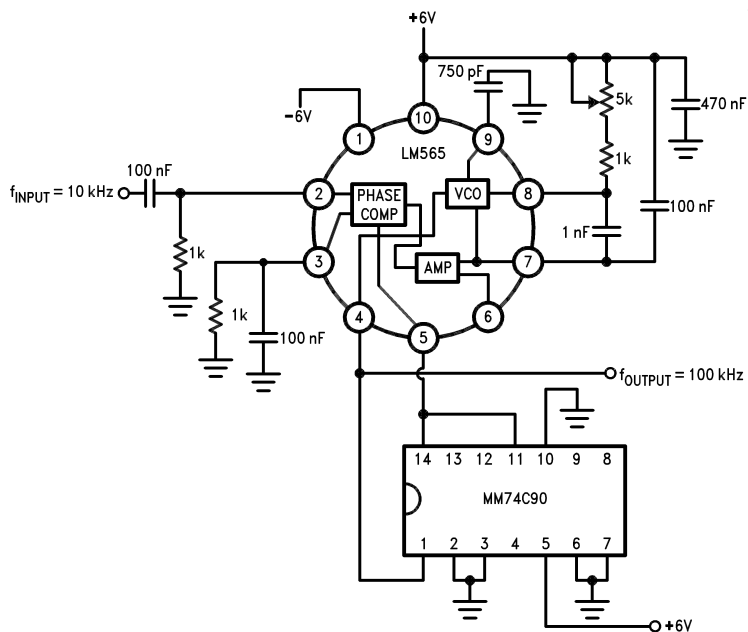
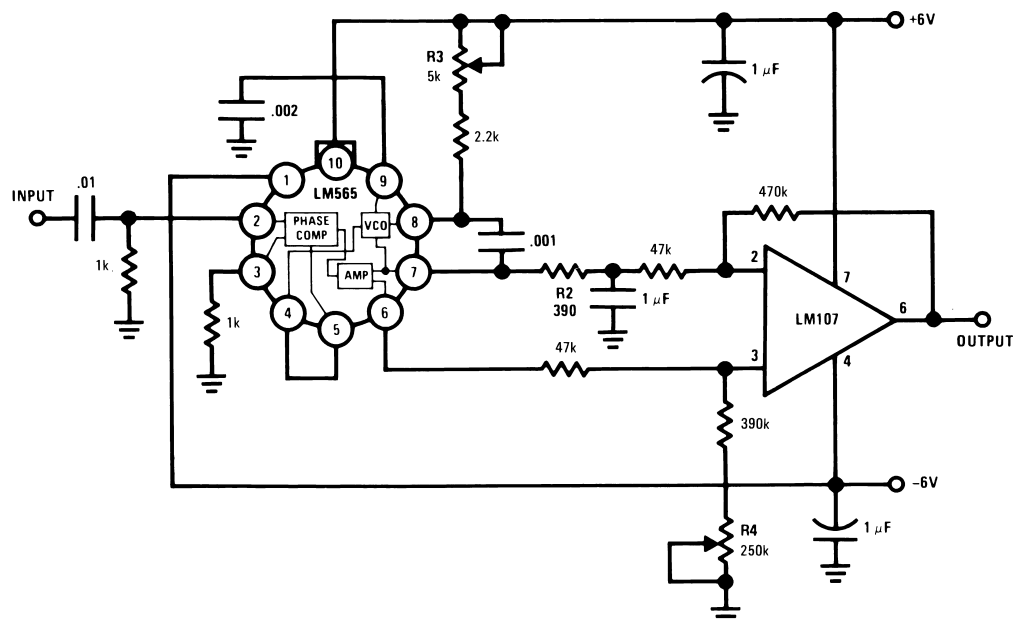
$$f_o \cong \frac{0.3}{R_o C_o} \quad (1)$$

LOOP GAIN: relates the amount of phase change between the input signal and the VCO signal for a shift in input signal frequency (assuming the loop remains in lock). In servo theory, this is called the “velocity error coefficient.”

$$\text{Loop gain} = K_o K_D \left(\frac{1}{\text{sec}} \right)$$

$$K_o = \text{oscillator sensitivity} \left(\frac{\text{radians/sec}}{\text{volt}} \right)$$

$$K_D = \text{phase detector sensitivity} \left(\frac{\text{volts}}{\text{radian}} \right) \quad (2)$$

The loop gain of the LM565 is dependent on supply voltage, and may be found from:

$$K_o K_D = \frac{33.6 f_o}{V_c} \quad (3)$$

f_o = VCO frequency in Hz

V_c = total supply voltage to circuit

Loop gain may be reduced by connecting a resistor between pins 6 and 7; this reduces the load impedance on the output amplifier and hence the loop gain.

HOLD IN RANGE: the range of frequencies that the loop will remain in lock after initially being locked.

$$f_H = \pm \frac{8 f_o}{V_c}$$

where

- f_o = free running frequency of VCO
- V_c = total supply voltage to the circuit

(4)

THE LOOP FILTER

In almost all applications, it will be desirable to filter the signal at the output of the phase detector (pin 7); this filter may take one of two forms:

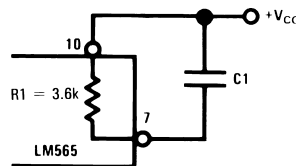

Figure 16. Simple Lead Filter

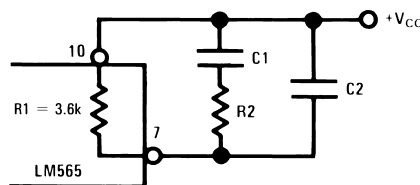

Figure 17. Lag-Lead Filter

A simple lag filter may be used for wide closed loop bandwidth applications such as modulation following where the frequency deviation of the carrier is fairly high (greater than 10%), or where wideband modulating signals must be followed.

The natural bandwidth of the closed loop response may be found from:

$$f_n = \frac{1}{2\pi} \sqrt{\frac{K_o K_D}{R_1 C_1}} \quad (5)$$

Associated with this is a damping factor:

$$\delta = \frac{1}{2} \sqrt{\frac{1}{R_1 C_1 K_o K_D}} \quad (6)$$

For narrow band applications where a narrow noise bandwidth is desired, such as applications involving tracking a slowly varying carrier, a lead lag filter should be used. In general, if $1/R_1 C_1 < K_o K_D$, the damping factor for the loop becomes quite small resulting in large overshoot and possible instability in the transient response of the loop. In this case, the natural frequency of the loop may be found from

$$f_n = \frac{1}{2\pi} \sqrt{\frac{K_o K_D}{\tau_1 + \tau_2}} \quad (7)$$

$$\tau_1 + \tau_2 = (R_1 + R_2) C_1 \quad (8)$$

R_2 is selected to produce a desired damping factor δ , usually between 0.5 and 1.0. The damping factor is found from the approximation:

$$\delta \cong \pi \tau_2 f_n \quad (8)$$

These two equations are plotted for convenience.

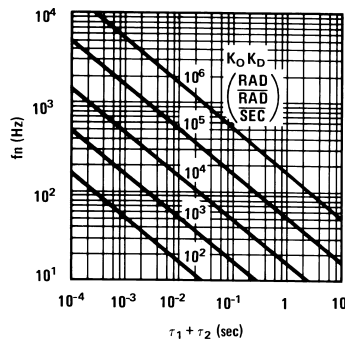

Figure 18. Filter Time Constant vs Natural Frequency

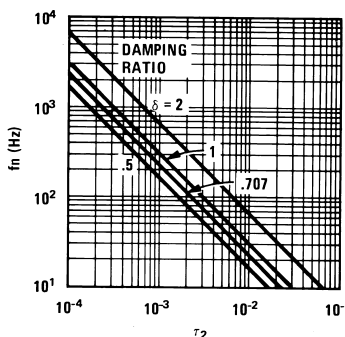

Figure 19. Damping Time Constant vs Natural Frequency

Capacitor C_2 should be much smaller than C_1 since its function is to provide filtering of carrier. In general $C_2 \leq 0.1 C_1$.

REVISION HISTORY

Changes from Revision A (April 2013) to Revision B	Page
• Changed layout of National Data Sheet to TI format	12

IMPORTANT NOTICE

Texas Instruments Incorporated and its subsidiaries (TI) reserve the right to make corrections, enhancements, improvements and other changes to its semiconductor products and services per JESD46, latest issue, and to discontinue any product or service per JESD48, latest issue. Buyers should obtain the latest relevant information before placing orders and should verify that such information is current and complete. All semiconductor products (also referred to herein as "components") are sold subject to TI's terms and conditions of sale supplied at the time of order acknowledgment.

TI warrants performance of its components to the specifications applicable at the time of sale, in accordance with the warranty in TI's terms and conditions of sale of semiconductor products. Testing and other quality control techniques are used to the extent TI deems necessary to support this warranty. Except where mandated by applicable law, testing of all parameters of each component is not necessarily performed.

TI assumes no liability for applications assistance or the design of Buyers' products. Buyers are responsible for their products and applications using TI components. To minimize the risks associated with Buyers' products and applications, Buyers should provide adequate design and operating safeguards.

TI does not warrant or represent that any license, either express or implied, is granted under any patent right, copyright, mask work right, or other intellectual property right relating to any combination, machine, or process in which TI components or services are used. Information published by TI regarding third-party products or services does not constitute a license to use such products or services or a warranty or endorsement thereof. Use of such information may require a license from a third party under the patents or other intellectual property of the third party, or a license from TI under the patents or other intellectual property of TI.

Reproduction of significant portions of TI information in TI data books or data sheets is permissible only if reproduction is without alteration and is accompanied by all associated warranties, conditions, limitations, and notices. TI is not responsible or liable for such altered documentation. Information of third parties may be subject to additional restrictions.

Resale of TI components or services with statements different from or beyond the parameters stated by TI for that component or service voids all express and any implied warranties for the associated TI component or service and is an unfair and deceptive business practice. TI is not responsible or liable for any such statements.

Buyer acknowledges and agrees that it is solely responsible for compliance with all legal, regulatory and safety-related requirements concerning its products, and any use of TI components in its applications, notwithstanding any applications-related information or support that may be provided by TI. Buyer represents and agrees that it has all the necessary expertise to create and implement safeguards which anticipate dangerous consequences of failures, monitor failures and their consequences, lessen the likelihood of failures that might cause harm and take appropriate remedial actions. Buyer will fully indemnify TI and its representatives against any damages arising out of the use of any TI components in safety-critical applications.

In some cases, TI components may be promoted specifically to facilitate safety-related applications. With such components, TI's goal is to help enable customers to design and create their own end-product solutions that meet applicable functional safety standards and requirements. Nonetheless, such components are subject to these terms.

No TI components are authorized for use in FDA Class III (or similar life-critical medical equipment) unless authorized officers of the parties have executed a special agreement specifically governing such use.

Only those TI components which TI has specifically designated as military grade or "enhanced plastic" are designed and intended for use in military/aerospace applications or environments. Buyer acknowledges and agrees that any military or aerospace use of TI components which have **not** been so designated is solely at the Buyer's risk, and that Buyer is solely responsible for compliance with all legal and regulatory requirements in connection with such use.

TI has specifically designated certain components as meeting ISO/TS16949 requirements, mainly for automotive use. In any case of use of non-designated products, TI will not be responsible for any failure to meet ISO/TS16949.

Products

Audio	www.ti.com/audio
Amplifiers	amplifier.ti.com
Data Converters	dataconverter.ti.com
DLP® Products	www.dlp.com
DSP	dsp.ti.com
Clocks and Timers	www.ti.com/clocks
Interface	interface.ti.com
Logic	logic.ti.com
Power Mgmt	power.ti.com
Microcontrollers	microcontroller.ti.com
RFID	www.ti-rfid.com
OMAP Applications Processors	www.ti.com/omap
Wireless Connectivity	www.ti.com/wirelessconnectivity

Applications

Automotive and Transportation	www.ti.com/automotive
Communications and Telecom	www.ti.com/communications
Computers and Peripherals	www.ti.com/computers
Consumer Electronics	www.ti.com/consumer-apps
Energy and Lighting	www.ti.com/energy
Industrial	www.ti.com/industrial
Medical	www.ti.com/medical
Security	www.ti.com/security
Space, Avionics and Defense	www.ti.com/space-avionics-defense
Video and Imaging	www.ti.com/video

TI E2E Community

e2e.ti.com