

LP2989LV Micropower 500 mA Low Noise Low Dropout Regulator for Applications with Output Voltages < 2V

Designed for Use with Very Low ESR Output Capacitors

Check for Samples: [LP2989LV](#)

FEATURES

- Ultra Low Dropout Voltage
- Ensured 500 mA Continuous Output Current
- Very Low Output Noise with External Capacitor
- SOIC-8, VSSOP, 8 Lead WSON Surface Mount Packages
- <0.8 μ A Quiescent Current when Shut Down
- Low Ground Pin Current at All Loads
- 0.75% Output Voltage Accuracy (“A” Grade)
- High Peak Current Capability (800 mA Typical)
- Wide Supply Voltage Range (16V Max)
- Overtemperature/Overcurrent Protection
- -40°C to $+125^{\circ}\text{C}$ Junction Temperature Range

APPLICATIONS

- Notebook/Desktop PC
- PDA/Palmtop Computer
- Wireless Communication Terminals
- SMPS Post-Regulator

Block Diagram

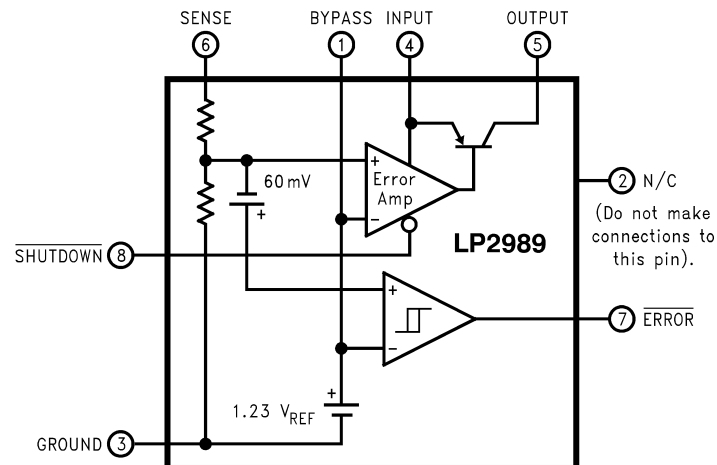

DESCRIPTION

The LP2989LV is a 500 mA fixed-output voltage regulator designed to provide high performance and low noise in applications requiring output voltages < 2V.

Output noise can be reduced to 18 μ V (typical) by connecting an external 10 nF capacitor to the bypass pin.

Using an optimized VIP (Vertically Integrated PNP) process, the LP2989LV delivers superior performance:

Ground Pin Current: Typically 3 mA @ 500 mA load, and 110 μ A @ 100 μ A load.

Sleep Mode: The LP2989LV draws less than 0.8 μ A quiescent current when shutdown pin is pulled low.

Error Flag: The built-in error flag goes low when the output drops approximately 5% below nominal.

Precision Output: Ensured output voltage accuracy is 0.75% (“A” grade) and 1.25% (standard grade) at room temperature.

For output voltages \geq 2V, see LP2989 data sheet.



Please be aware that an important notice concerning availability, standard warranty, and use in critical applications of Texas Instruments semiconductor products and disclaimers thereto appears at the end of this data sheet.

All trademarks are the property of their respective owners.

Connection Diagrams

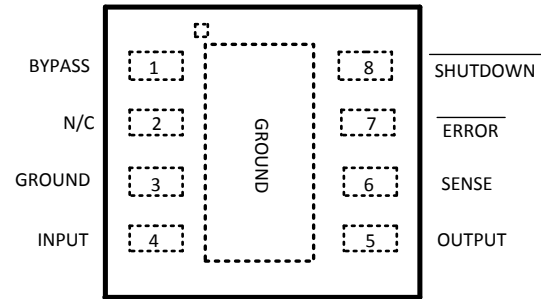
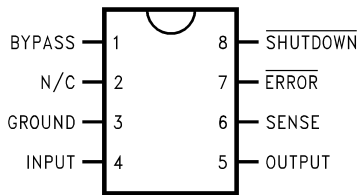

Figure 1. SOIC-8/ VSSOP Package Surface Mount Packages

See Package Drawing Numbers D0008A/DGK0008A

Figure 2. 8 Lead WSON Surface Mount Package (Top View)

See Package Number NGN0008A

Basic Application Circuit

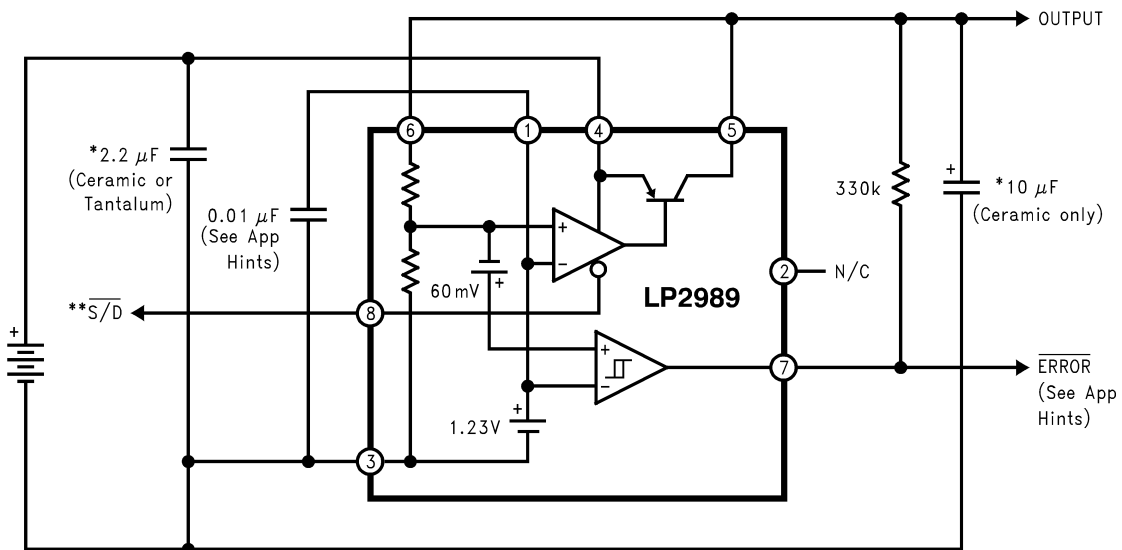

*Capacitance values shown are minimum required to assure stability, but may be increased without limit. Larger output capacitor provides improved dynamic response.

**Shutdown must be actively terminated (see APPLICATION HINTS). Tie to INPUT (Pin4) if not used.



These devices have limited built-in ESD protection. The leads should be shorted together or the device placed in conductive foam during storage or handling to prevent electrostatic damage to the MOS gates.

ABSOLUTE MAXIMUM RATINGS ⁽¹⁾⁽²⁾

| | |
|------------------------------------------------|-------------------------|
| Storage Temperature Range | -65°C to +150°C |
| Operating Junction Temperature Range | -40°C to +125°C |
| Lead Temperature (Soldering, 5 seconds) | 260°C |
| ESD Rating ⁽³⁾ | 2 kV |
| Power Dissipation ⁽⁴⁾ | Internally Limited |
| Input Supply Voltage (Survival) | -0.3V to +16V |
| Input Supply Voltage (Operating) | 2.1V to +16V |
| Sense Pin | -0.3V to +6V |
| Output Voltage (Survival) ⁽⁵⁾ | -0.3V to +16V |
| I _{OUT} (Survival) | Short Circuit Protected |
| Input-Output Voltage (Survival) ⁽⁶⁾ | -0.3V to +16V |

- (1) Absolute Maximum Ratings indicate limits beyond which damage to the component may occur. Electrical specifications do not apply when operating the device outside of its rated operating conditions.
- (2) If Military/Aerospace specified devices are required, please contact the Texas Instruments Sales Office/Distributors for availability and specifications.
- (3) ESD testing was performed using Human Body Model, a 100 pF capacitor discharged through a 1.5 kΩ resistor.
- (4) The maximum allowable power dissipation is a function of the maximum junction temperature, T_J(MAX), the junction-to-ambient thermal resistance, θ_{J-A}, and the ambient temperature, T_A. The maximum allowable power dissipation at any ambient temperature is calculated using:

$$P(\text{MAX}) = \frac{T_J(\text{MAX}) - T_A}{\theta_{J-A}}$$

The value of θ_{J-A} for the SOIC-8 (D) package is 160°C/W and the VSSOP (DGK) package is 200°C/W. The value θ_{J-A} for the WSON (NGN) package is specifically dependent on PCB trace area, trace material, and the number of layers and thermal vias. For improved thermal resistance and power dissipation for the WSON package, refer to Application Note AN-1187 ([SNOA401Q](#)). Exceeding the maximum allowable power dissipation will cause excessive die temperature, and the regulator will go into thermal shutdown.

- (5) If used in a dual-supply system where the regulator load is returned to a negative supply, the LP2989LV output must be diode-clamped to ground.
- (6) The output PNP structure contains a diode between the V_{IN} and V_{OUT} terminals that is normally reverse-biased. Forcing the output above the input will turn on this diode and may induce a latch-up mode which can damage the part (see [APPLICATION HINTS](#)).

ELECTRICAL CHARACTERISTICS

Limits in standard typeface are for T_J = 25°C, and limits in **boldface type** apply over the full operating temperature range. Unless otherwise specified: V_{IN} = V_O(NOM) + 1V, I_L = 1 mA, C_{OUT} = 10 μF, C_{IN} = 2.2 μF, V_{SD} = 2V.

| Symbol | Parameter | Conditions | Typical | LP2989AI-X.X ⁽¹⁾ | | LP2989I-X.X ⁽¹⁾ | | Units |
|------------------------------------|--------------------------------------------------------------|-----------------------------------------------------------------------------------------------------------------------|---------|-----------------------------|--------------|----------------------------|--------------|-------------------|
| | | | | Min | Max | Min | Max | |
| V _O | Output Voltage Tolerance | | | -0.75 | 0.75 | -1.25 | 1.25 | %V _{NOM} |
| | | 1 mA < I _L < 500 mA V _O (NOM) + 1V ≤ V _{IN} ≤ 16V | | -1.5 | 1.5 | -2.5 | 2.5 | |
| | | 1 mA < I _L < 500 mA V _O (NOM) + 1V ≤ V _{IN} ≤ 16V -25°C ≤ T _J ≤ 125°C | | -4.0 | 2.5 | -5.0 | 3.5 | |
| $\frac{\Delta V_O}{\Delta V_{IN}}$ | Output Voltage Line Regulation | V _O (NOM) + 1V ≤ V _{IN} ≤ 16V | 0.005 | | 0.014 | | 0.014 | %V |
| | | | | | 0.032 | | 0.032 | |
| $\frac{\Delta V_O}{\Delta I_L}$ | Load Regulation | 1 mA < I _L < 500 mA | 0.4 | | | | | %V _{NOM} |
| V _{IN} (min) | Minimum Input Voltage Required To Maintain Output Regulation | V _{OUT} = 1.8 I _L ≤ 50 mA | 1.96 | | | | | V |
| | | V _{OUT} = 1.8 I _L = 250 mA | 1.98 | | | | | |
| | | V _{OUT} = 1.8 I _L = 500 mA | 2.11 | | | | | |

- (1) Limits are 100% production tested at 25°C. Limits over the operating temperature range are specified through correlation using Statistical Quality Control (SQC) methods. The limits are used to calculate Average Outgoing Quality Level (AOQL).

ELECTRICAL CHARACTERISTICS (continued)

Limits in standard typeface are for $T_J = 25^\circ\text{C}$, and limits in **boldface type** apply over the full operating temperature range. Unless otherwise specified: $V_{IN} = V_O(\text{NOM}) + 1\text{V}$, $I_L = 1\text{ mA}$, $C_{OUT} = 10\ \mu\text{F}$, $C_{IN} = 2.2\ \mu\text{F}$, $V_{S/D} = 2\text{V}$.

| Symbol | Parameter | Conditions | Typical | LP2989AI-X.X ⁽¹⁾ | | LP2989I-X.X ⁽¹⁾ | | Units |
|------------------------------------------------------|----------------------------------------|-----------------------------------------------------------------------------------------------|------------|-----------------------------|-------------|----------------------------|-------------|-----------------------|
| | | | | Min | Max | Min | Max | |
| I_{GND} | Ground Pin Current | $I_L = 100\ \mu\text{A}$ | 110 | | 175 | | 175 | μA |
| | | | | | 200 | | 200 | |
| | | $I_L = 200\ \text{mA}$ | 1 | | 2 | | 2 | mA |
| | | | | | 3.5 | | 3.5 | |
| | | $I_L = 500\ \text{mA}$ | 3 | | 6 | | 6 | |
| | | | 9 | | 9 | | | |
| | | $V_{S/D} < 0.18\text{V}$ | 0.5 | | 2 | | 2 | μA |
| | | $V_{S/D} < 0.4\text{V}$ | 0.05 | | 0.8 | | 0.8 | |
| $I_{\text{O(PK)}}$ | Peak Output Current | $V_{\text{OUT}} \geq V_{\text{O(NOM)}} - 5\%$ | 800 | 600 | | 600 | | mA |
| $I_{\text{O(MAX)}}$ | Short Circuit Current | $R_L = 0$ (Steady State) ⁽²⁾ | 1000 | | | | | |
| e_n | Output Noise Voltage (RMS) | $\text{BW} = 100\ \text{Hz to } 100\ \text{kHz}$, $C_{\text{BYPASS}} = .01\ \mu\text{F}$ | 18 | | | | | $\mu\text{V(RMS)}$ |
| $\frac{\Delta V_{\text{OUT}}}{\Delta V_{\text{IN}}}$ | Ripple Rejection | $f = 1\ \text{kHz}$ | 60 | | | | | dB |
| $\frac{\Delta V_{\text{OUT}}}{\Delta T}$ | Output Voltage Temperature Coefficient | See ⁽³⁾ | 20 | | | | | ppm/ $^\circ\text{C}$ |
| SHUTDOWN INPUT | | | | | | | | |
| $V_{S/D}$ | S/D Input Voltage | $V_H = \text{O/P ON}$ | 1.4 | 1.6 | | 1.6 | | V |
| | | $V_L = \text{O/P OFF}$ $I_{\text{IN}} \leq 2\ \mu\text{A}$ | 0.50 | | 0.18 | | 0.18 | |
| $I_{S/D}$ | S/D Input Current | $V_{S/D} = 0$ | 0.001 | | -1 | | -1 | μA |
| | | $V_{S/D} = 5\text{V}$ | 5 | | 15 | | 15 | |
| ERROR COMPARATOR | | | | | | | | |
| I_{OH} | Output "HIGH" Leakage | $V_{\text{OH}} = 16\text{V}$ | 0.001 | | 1 | | 1 | μA |
| | | | | | 2 | | 2 | |
| V_{OL} | Output "LOW" Voltage | $V_{\text{OUT}} = V_{\text{O(NOM)}} - 0.5\text{V}$ $I_{\text{O(Comp)}} = 150\ \mu\text{A}$ | 150 | | 220 | | 220 | mV |
| | | | | | 350 | | 350 | |
| $V_{\text{THR (MAX)}}$ | Upper Threshold Voltage | | -4.8 | -6.0 | -3.5 | -6.0 | -3.5 | % V_{OUT} |
| | | | | -8.3 | -2.5 | -8.3 | -2.5 | |
| $V_{\text{THR (MIN)}}$ | Lower Threshold Voltage | | -6.6 | -8.9 | -4.9 | -8.9 | -4.9 | |
| | | | | -13.0 | -3.0 | -13.0 | -3.0 | |
| HYST | Hysteresis | | 2.0 | | | | | |

(2) See [TYPICAL PERFORMANCE CHARACTERISTICS](#) curves.

(3) Temperature coefficient is defined as the maximum (worst-case) change divided by the total temperature range.

TYPICAL PERFORMANCE CHARACTERISTICS

Unless otherwise specified: $T_A = 25^\circ\text{C}$, $C_{OUT} = 10\ \mu\text{F}$, $C_{IN} = 2.2\ \mu\text{F}$, S/D is tied to V_{IN} , $V_{IN} = V_O(\text{NOM}) + 1\text{V}$, $I_L = 1\ \text{mA}$, $V_{OUT} = 1.8\text{V}$.

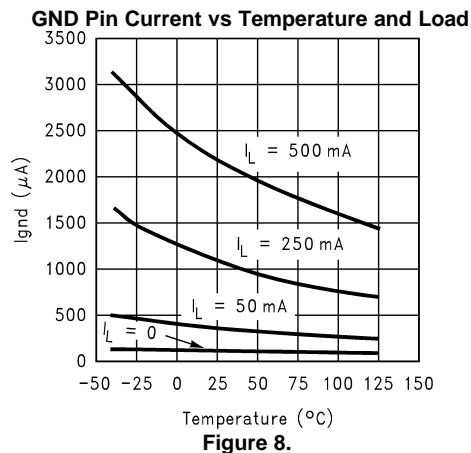
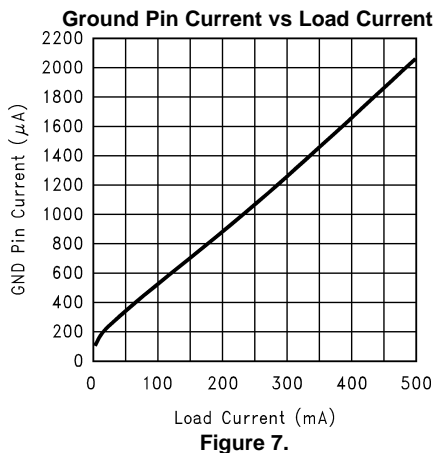
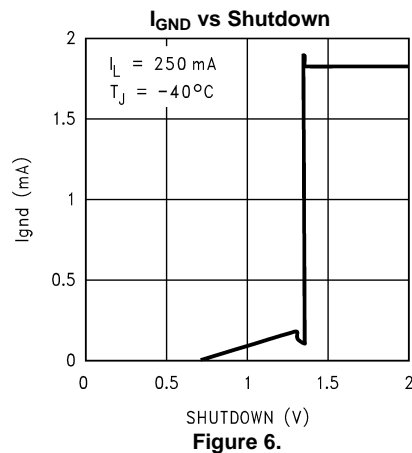
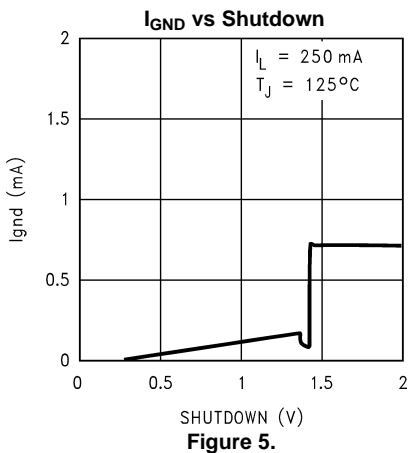
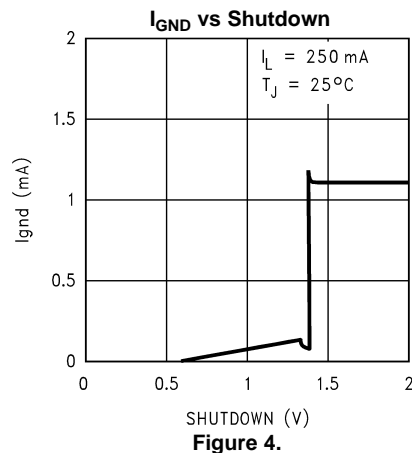
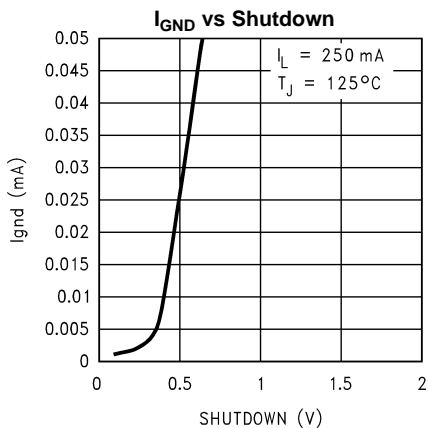

TYPICAL PERFORMANCE CHARACTERISTICS (continued)

Unless otherwise specified: $T_A = 25^\circ\text{C}$, $C_{OUT} = 10\ \mu\text{F}$, $C_{IN} = 2.2\ \mu\text{F}$, S/D is tied to V_{IN} , $V_{IN} = V_{O(NOM)} + 1\text{V}$, $I_L = 1\ \text{mA}$, $V_{OUT} = 1.8\text{V}$.

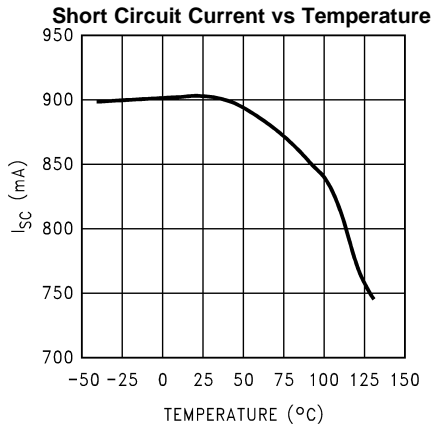

Figure 9.

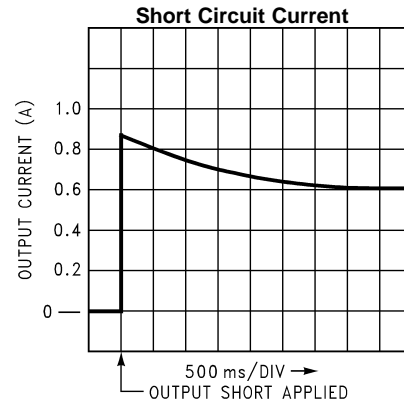

Figure 10.

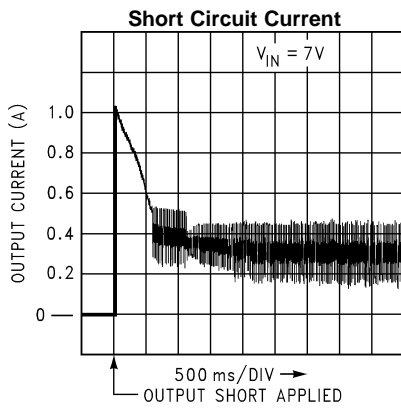

Figure 11.

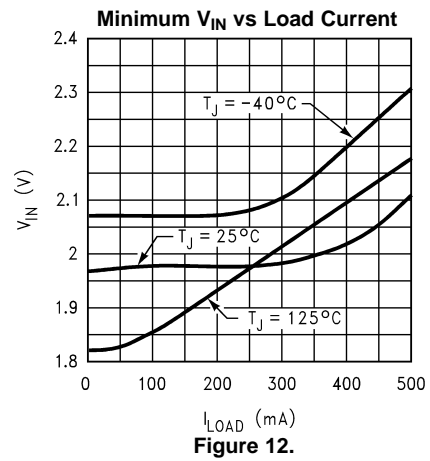

Figure 12.

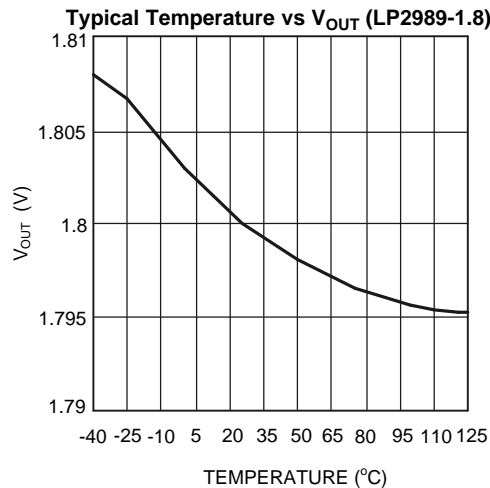

Figure 13.

APPLICATION HINTS

WSO Package Devices

The LP2989LV is offered in the 8 lead WSON surface mount package to allow for increased power dissipation compared to the SOIC-8 and VSSOP. For details on thermal performance as well as mounting and soldering specifications, refer to Application Note AN-1187 ([SNOA401Q](#)).

For output voltages $\geq 2V$, see LP2989 data sheet.

External Capacitors

Like any low-dropout regulator, the LP2989LV requires external capacitors for regulator stability. These capacitors must be correctly selected for good performance.

Input Capacitor: An input capacitor whose capacitance is at least 2.2 μF is required between the LP2989LV input and ground (the amount of capacitance may be increased without limit).

Characterization testing performed on the LP2989LV has shown that if the amount of actual input capacitance drops below about 1.5 μF , an unstable operating condition may result. Therefore, the next larger standard size (2.2 μF) is specified as the minimum required input capacitance. Capacitor tolerance and temperature variation must be considered when selecting a capacitor (see [Capacitor Characteristics](#) section) to assure the minimum requirement of 1.5 μF is met over all operating conditions.

The input capacitor must be located at a distance of not more than 0.5" from the input pin and returned to a clean analog ground. Any good quality ceramic or tantalum may be used for this capacitor, assuming the minimum capacitance requirement is met.

Output Capacitor: The LP2989LV requires a ceramic output capacitor whose size is at least 10 μF . The actual amount of capacitance on the output must never drop below about 7 μF or unstable operation may result. For this reason, capacitance tolerance and temperature characteristics must be considered when selecting an output capacitor

The LP2989LV is designed specifically to work with ceramic output capacitors, utilizing circuitry which allows the regulator to be stable across the entire range of output current with an output capacitor whose ESR is as low as 4 m Ω . It may also be possible to use Tantalum or film capacitors at the output, but these are not as attractive for reasons of size and cost (see [Capacitor Characteristics](#) section).

The output capacitor must meet the requirement for minimum amount of capacitance and also have an ESR (equivalent series resistance) value which is within the stable range. Curves are provided which show the stable ESR range as a function of load current (see [Figure 14](#)).

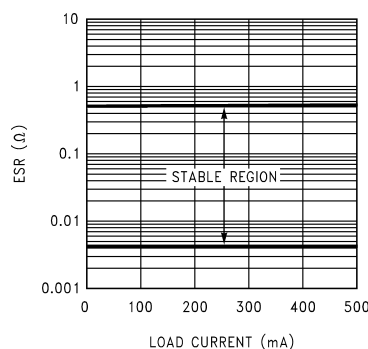

Figure 14. Stable Region For Output Capacitor ESR

Important: The output capacitor must maintain its ESR within the stable region *over the full operating temperature range of the application* to assure stability.

It is important to remember that capacitor tolerance and variation with temperature must be taken into consideration when selecting an output capacitor so that the minimum required amount of output capacitance is provided over the full operating temperature range. (See [Capacitor Characteristics](#) section.)

The output capacitor must be located not more than 0.5" from the output pin and returned to a clean analog ground.

Noise Bypass Capacitor: Connecting a 10 nF capacitor to the Bypass pin significantly reduces noise on the regulator output. However, the capacitor is connected directly to a high-impedance circuit in the bandgap reference.

Because this circuit has only a few microamperes flowing in it, any significant loading on this node will cause a change in the regulated output voltage. For this reason, DC leakage current through the noise bypass capacitor must never exceed 100 nA, and should be kept as low as possible for best output voltage accuracy.

The types of capacitors best suited for the noise bypass capacitor are ceramic and film. High-quality ceramic capacitors with either NPO or COG dielectric typically have very low leakage. 10 nF polypropylene and polycarbonate film capacitors are available in small surface-mount packages and typically have extremely low leakage current.

Capacitor Characteristics

Ceramic: The LP2989LV was designed to work with ceramic capacitors on the output to take advantage of the benefits they offer: for capacitance values in the 10 μF range, ceramics are the least expensive and also have the lowest ESR values (which makes them best for eliminating high-frequency noise). The ESR of a typical 10 μF ceramic capacitor is in the range of 5 m Ω to 10 m Ω , which meets the ESR limits required for stability by the LP2989LV.

One disadvantage of ceramic capacitors is that their capacitance can vary with temperature. Many large value ceramic capacitors ($\geq 2.2 \mu\text{F}$) are manufactured with the Z5U or Y5V temperature characteristic, which results in the capacitance dropping by more than 50% as the temperature goes from 25°C to 85°C.

This could cause problems if a 10 μF Y5V capacitor were used on the output since it will drop down to approximately 5 μF at high ambient temperatures (which could cause the LP2989LV to oscillate).

Another significant problem with Z5U and Y5V dielectric devices is that the capacitance drops severely with applied voltage. A typical Z5U or Y5V capacitor can lose 60% of its rated capacitance with half of the rated voltage applied to it.

For these reasons, X7R and X5R type ceramic capacitors must be used on the input and output of the LP2989LV.

Tantalum: Tantalum output capacitors are not recommended for use with the LP2989LV because:

Tantalum capacitors are less desirable than ceramics for use as output capacitors because they are typically more expensive when comparing equivalent capacitance and voltage ratings in the 1 μF to 10 μF range.

Another important consideration is that Tantalum capacitors have higher ESR values than equivalent size ceramics. This means that while it may be possible to find a Tantalum capacitor with an ESR value within the stable range, it would have to be larger in capacitance (which means bigger and more costly) than a ceramic capacitor with the same ESR value.

Most 10 μF Tantalum capacitors have ESR values higher than the 0.5 Ω maximum limit required to make the LP2989LV stable.

It should also be noted that the ESR of a typical Tantalum will increase about 2:1 as the temperature goes from 25°C down to -40°C, so some guard band must be allowed.

Film: Polycarbonate and polypropylene film capacitors have excellent electrical performance: their ESR is the lowest of the three types listed, their capacitance is very stable with temperature, and DC leakage current is extremely low.

One disadvantage is that film capacitors are larger in physical size than ceramic or tantalum which makes film a poor choice for either input or output capacitors.

However, their low leakage makes them a good choice for the noise bypass capacitor. Since the required amount of capacitance is only .01 μF , small surface-mount film capacitors are available in this size.

Shutdown Input Operation

The LP2989LV is shut off by driving the Shutdown input low, and turned on by pulling it high. If this feature is not to be used, the Shutdown input should be tied to V_{IN} to keep the regulator output on at all times.

To assure proper operation, the signal source used to drive the Shutdown input must be able to swing above and below the specified turn-on/turn-off voltage thresholds listed in the [ELECTRICAL CHARACTERISTICS](#) section under $V_{ON/OFF}$.

Reverse Input-Output Voltage

The PNP power transistor used as the pass element in the LP2989LV has an inherent diode connected between the regulator output and input.

During normal operation (where the input voltage is higher than the output) this diode is reverse-biased.

However, if the output is pulled above the input, this diode will turn ON and current will flow into the regulator output.

In such cases, a parasitic SCR can latch which will allow a high current to flow into V_{IN} (and out the ground pin), which can damage the part.

In any application where the output may be pulled above the input, an external Schottky diode must be connected from V_{IN} to V_{OUT} (cathode on V_{IN} , anode on V_{OUT}), to limit the reverse voltage across the LP2989LV to 0.3V (see [ABSOLUTE MAXIMUM RATINGS](#)).

REVISION HISTORY

| Changes from Revision I (April 2013) to Revision J | Page |
|------------------------------------------------------------|-------------------|
| • Changed layout of National Data Sheet to TI format | 9 |

PACKAGING INFORMATION

| Orderable Device | Status (1) | Package Type | Package Drawing | Pins | Package Qty | Eco Plan (2) | Lead/Ball Finish | MSL Peak Temp (3) | Op Temp (°C) | Top-Side Markings (4) | Samples |
|---------------------|---------------|--------------|-----------------|------|-------------|-------------------------|------------------|----------------------|--------------|--------------------------|-------------------------|
| LP2989AILD-1.8/NOPB | ACTIVE | WSON | NGN | 8 | 1000 | Green (RoHS & no Sb/Br) | SN | Level-3-260C-168 HR | -40 to 125 | L01EA | Samples |
| LP2989AILD-1.8/NOPB | ACTIVE | WSON | NGN | 8 | 4500 | Green (RoHS & no Sb/Br) | SN | Level-3-260C-168 HR | | L01EA | Samples |
| LP2989AIM-1.8 | ACTIVE | SOIC | D | 8 | 95 | TBD | Call TI | Call TI | -40 to 125 | 2989A IM1.8 | Samples |
| LP2989AIM-1.8/NOPB | ACTIVE | SOIC | D | 8 | 95 | Green (RoHS & no Sb/Br) | CU SN | Level-1-260C-UNLIM | -40 to 125 | 2989A IM1.8 | Samples |
| LP2989AIMX-1.8 | ACTIVE | SOIC | D | 8 | 2500 | TBD | Call TI | Call TI | -40 to 125 | 2989A IM1.8 | Samples |
| LP2989AIMX-1.8/NOPB | ACTIVE | SOIC | D | 8 | 2500 | Green (RoHS & no Sb/Br) | CU SN | Level-1-260C-UNLIM | -40 to 125 | 2989A IM1.8 | Samples |
| LP2989ILD-1.8/NOPB | ACTIVE | WSON | NGN | 8 | 1000 | Green (RoHS & no Sb/Br) | SN | Level-3-260C-168 HR | -40 to 125 | L01EA B | Samples |
| LP2989ILD-1.8/NOPB | ACTIVE | WSON | NGN | 8 | 4500 | Green (RoHS & no Sb/Br) | SN | Level-3-260C-168 HR | | L01EA B | Samples |
| LP2989IM-1.8 | ACTIVE | SOIC | D | 8 | 95 | TBD | Call TI | Call TI | -40 to 125 | 2989 IM1.8 | Samples |
| LP2989IM-1.8/NOPB | ACTIVE | SOIC | D | 8 | 95 | Green (RoHS & no Sb/Br) | CU SN | Level-1-260C-UNLIM | -40 to 125 | 2989 IM1.8 | Samples |
| LP2989IMX-1.8 | ACTIVE | SOIC | D | 8 | 2500 | TBD | Call TI | Call TI | -40 to 125 | 2989 IM1.8 | Samples |
| LP2989IMX-1.8/NOPB | ACTIVE | SOIC | D | 8 | 2500 | Green (RoHS & no Sb/Br) | CU SN | Level-1-260C-UNLIM | -40 to 125 | 2989 IM1.8 | Samples |

(1) The marketing status values are defined as follows:

ACTIVE: Product device recommended for new designs.

LIFEBUY: TI has announced that the device will be discontinued, and a lifetime-buy period is in effect.

NRND: Not recommended for new designs. Device is in production to support existing customers, but TI does not recommend using this part in a new design.

PREVIEW: Device has been announced but is not in production. Samples may or may not be available.

OBSELETE: TI has discontinued the production of the device.

(2) Eco Plan - The planned eco-friendly classification: Pb-Free (RoHS), Pb-Free (RoHS Exempt), or Green (RoHS & no Sb/Br) - please check <http://www.ti.com/productcontent> for the latest availability information and additional product content details.

TBD: The Pb-Free/Green conversion plan has not been defined.

Pb-Free (RoHS): TI's terms "Lead-Free" or "Pb-Free" mean semiconductor products that are compatible with the current RoHS requirements for all 6 substances, including the requirement that lead not exceed 0.1% by weight in homogeneous materials. Where designed to be soldered at high temperatures, TI Pb-Free products are suitable for use in specified lead-free processes.

Pb-Free (RoHS Exempt): This component has a RoHS exemption for either 1) lead-based flip-chip solder bumps used between the die and package, or 2) lead-based die adhesive used between the die and leadframe. The component is otherwise considered Pb-Free (RoHS compatible) as defined above.

Green (RoHS & no Sb/Br): TI defines "Green" to mean Pb-Free (RoHS compatible), and free of Bromine (Br) and Antimony (Sb) based flame retardants (Br or Sb do not exceed 0.1% by weight in homogeneous material)

⁽³⁾ MSL, Peak Temp. -- The Moisture Sensitivity Level rating according to the JEDEC industry standard classifications, and peak solder temperature.

⁽⁴⁾ Multiple Top-Side Markings will be inside parentheses. Only one Top-Side Marking contained in parentheses and separated by a "~" will appear on a device. If a line is indented then it is a continuation of the previous line and the two combined represent the entire Top-Side Marking for that device.

Important Information and Disclaimer: The information provided on this page represents TI's knowledge and belief as of the date that it is provided. TI bases its knowledge and belief on information provided by third parties, and makes no representation or warranty as to the accuracy of such information. Efforts are underway to better integrate information from third parties. TI has taken and continues to take reasonable steps to provide representative and accurate information but may not have conducted destructive testing or chemical analysis on incoming materials and chemicals. TI and TI suppliers consider certain information to be proprietary, and thus CAS numbers and other limited information may not be available for release.

In no event shall TI's liability arising out of such information exceed the total purchase price of the TI part(s) at issue in this document sold by TI to Customer on an annual basis.

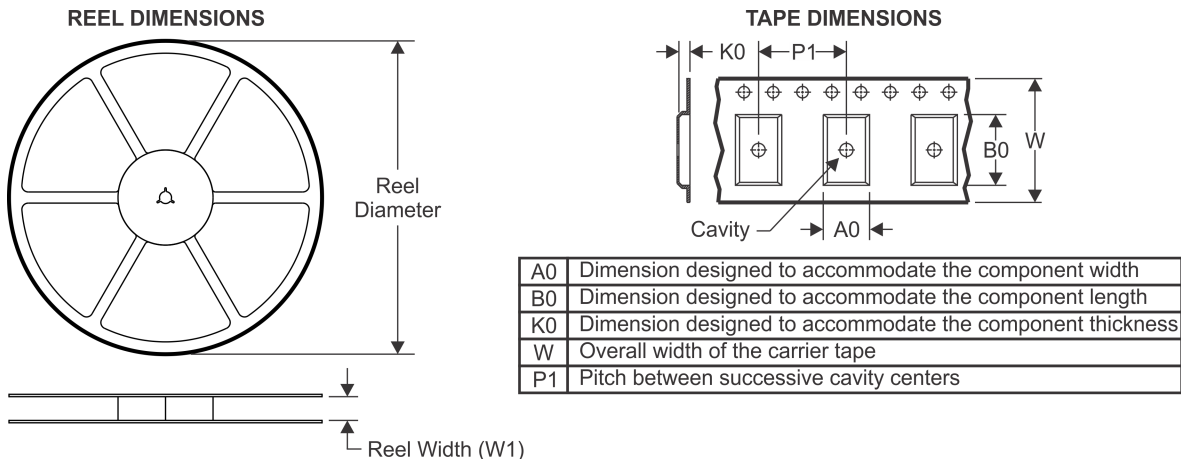
TAPE AND REEL INFORMATION

QUADRANT ASSIGNMENTS FOR PIN 1 ORIENTATION IN TAPE

*All dimensions are nominal

| Device | Package Type | Package Drawing | Pins | SPQ | Reel Diameter (mm) | Reel Width W1 (mm) | A0 (mm) | B0 (mm) | K0 (mm) | P1 (mm) | W (mm) | Pin1 Quadrant |
|---------------------|--------------|-----------------|------|------|--------------------|--------------------|---------|---------|---------|---------|--------|---------------|
| LP2989AILD-1.8/NOPB | WSON | NGN | 8 | 1000 | 178.0 | 12.4 | 4.3 | 4.3 | 1.3 | 8.0 | 12.0 | Q1 |
| LP2989AILD-1.8/NOPB | WSON | NGN | 8 | 4500 | 330.0 | 12.4 | 4.3 | 4.3 | 1.3 | 8.0 | 12.0 | Q1 |
| LP2989AIMX-1.8 | SOIC | D | 8 | 2500 | 330.0 | 12.4 | 6.5 | 5.4 | 2.0 | 8.0 | 12.0 | Q1 |
| LP2989AIMX-1.8/NOPB | SOIC | D | 8 | 2500 | 330.0 | 12.4 | 6.5 | 5.4 | 2.0 | 8.0 | 12.0 | Q1 |
| LP2989ILD-1.8/NOPB | WSON | NGN | 8 | 1000 | 178.0 | 12.4 | 4.3 | 4.3 | 1.3 | 8.0 | 12.0 | Q1 |
| LP2989ILD-1.8/NOPB | WSON | NGN | 8 | 4500 | 330.0 | 12.4 | 4.3 | 4.3 | 1.3 | 8.0 | 12.0 | Q1 |
| LP2989IMX-1.8 | SOIC | D | 8 | 2500 | 330.0 | 12.4 | 6.5 | 5.4 | 2.0 | 8.0 | 12.0 | Q1 |
| LP2989IMX-1.8/NOPB | SOIC | D | 8 | 2500 | 330.0 | 12.4 | 6.5 | 5.4 | 2.0 | 8.0 | 12.0 | Q1 |

TAPE AND REEL BOX DIMENSIONS



*All dimensions are nominal

| Device | Package Type | Package Drawing | Pins | SPQ | Length (mm) | Width (mm) | Height (mm) |
|---------------------|--------------|-----------------|------|------|-------------|------------|-------------|
| LP2989AILD-1.8/NOPB | WSON | NGN | 8 | 1000 | 213.0 | 191.0 | 55.0 |
| LP2989AILD-1.8/NOPB | WSON | NGN | 8 | 4500 | 367.0 | 367.0 | 35.0 |
| LP2989AIMX-1.8 | SOIC | D | 8 | 2500 | 367.0 | 367.0 | 35.0 |
| LP2989AIMX-1.8/NOPB | SOIC | D | 8 | 2500 | 367.0 | 367.0 | 35.0 |
| LP2989ILD-1.8/NOPB | WSON | NGN | 8 | 1000 | 213.0 | 191.0 | 55.0 |
| LP2989ILD-1.8/NOPB | WSON | NGN | 8 | 4500 | 367.0 | 367.0 | 35.0 |
| LP2989IMX-1.8 | SOIC | D | 8 | 2500 | 367.0 | 367.0 | 35.0 |
| LP2989IMX-1.8/NOPB | SOIC | D | 8 | 2500 | 367.0 | 367.0 | 35.0 |

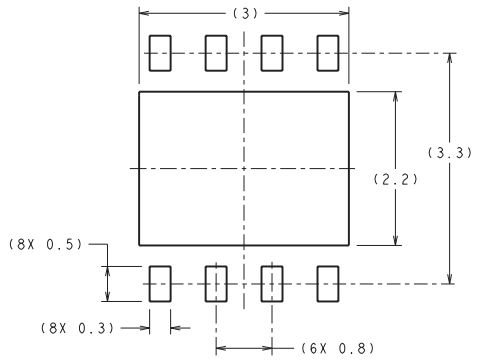
NGN0008A

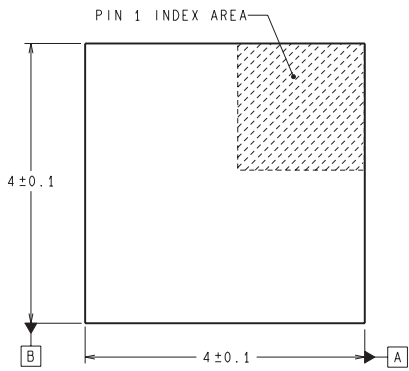

RECOMMENDED LAND PATTERN
1:1 RATION WITH PKG SOLDER PADS



DIMENSIONS ARE IN MILLIMETERS
DIMENSIONS IN () FOR REFERENCE ONLY

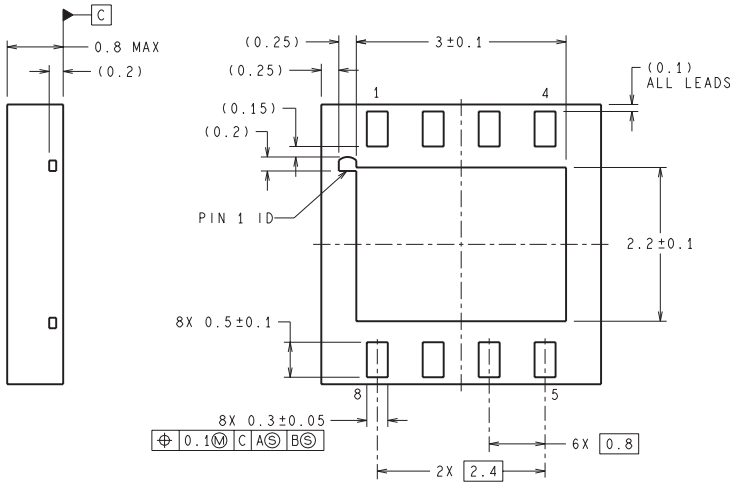



LDC08A (Rev B)

D (R-PDSO-G8)

PLASTIC SMALL OUTLINE



- NOTES:
- A. All linear dimensions are in inches (millimeters).
 - B. This drawing is subject to change without notice.
 -  Body length does not include mold flash, protrusions, or gate burrs. Mold flash, protrusions, or gate burrs shall not exceed 0.006 (0,15) each side.
 -  Body width does not include interlead flash. Interlead flash shall not exceed 0.017 (0,43) each side.
 - E. Reference JEDEC MS-012 variation AA.

IMPORTANT NOTICE

Texas Instruments Incorporated and its subsidiaries (TI) reserve the right to make corrections, enhancements, improvements and other changes to its semiconductor products and services per JESD46, latest issue, and to discontinue any product or service per JESD48, latest issue. Buyers should obtain the latest relevant information before placing orders and should verify that such information is current and complete. All semiconductor products (also referred to herein as "components") are sold subject to TI's terms and conditions of sale supplied at the time of order acknowledgment.

TI warrants performance of its components to the specifications applicable at the time of sale, in accordance with the warranty in TI's terms and conditions of sale of semiconductor products. Testing and other quality control techniques are used to the extent TI deems necessary to support this warranty. Except where mandated by applicable law, testing of all parameters of each component is not necessarily performed.

TI assumes no liability for applications assistance or the design of Buyers' products. Buyers are responsible for their products and applications using TI components. To minimize the risks associated with Buyers' products and applications, Buyers should provide adequate design and operating safeguards.

TI does not warrant or represent that any license, either express or implied, is granted under any patent right, copyright, mask work right, or other intellectual property right relating to any combination, machine, or process in which TI components or services are used. Information published by TI regarding third-party products or services does not constitute a license to use such products or services or a warranty or endorsement thereof. Use of such information may require a license from a third party under the patents or other intellectual property of the third party, or a license from TI under the patents or other intellectual property of TI.

Reproduction of significant portions of TI information in TI data books or data sheets is permissible only if reproduction is without alteration and is accompanied by all associated warranties, conditions, limitations, and notices. TI is not responsible or liable for such altered documentation. Information of third parties may be subject to additional restrictions.

Resale of TI components or services with statements different from or beyond the parameters stated by TI for that component or service voids all express and any implied warranties for the associated TI component or service and is an unfair and deceptive business practice. TI is not responsible or liable for any such statements.

Buyer acknowledges and agrees that it is solely responsible for compliance with all legal, regulatory and safety-related requirements concerning its products, and any use of TI components in its applications, notwithstanding any applications-related information or support that may be provided by TI. Buyer represents and agrees that it has all the necessary expertise to create and implement safeguards which anticipate dangerous consequences of failures, monitor failures and their consequences, lessen the likelihood of failures that might cause harm and take appropriate remedial actions. Buyer will fully indemnify TI and its representatives against any damages arising out of the use of any TI components in safety-critical applications.

In some cases, TI components may be promoted specifically to facilitate safety-related applications. With such components, TI's goal is to help enable customers to design and create their own end-product solutions that meet applicable functional safety standards and requirements. Nonetheless, such components are subject to these terms.

No TI components are authorized for use in FDA Class III (or similar life-critical medical equipment) unless authorized officers of the parties have executed a special agreement specifically governing such use.

Only those TI components which TI has specifically designated as military grade or "enhanced plastic" are designed and intended for use in military/aerospace applications or environments. Buyer acknowledges and agrees that any military or aerospace use of TI components which have **not** been so designated is solely at the Buyer's risk, and that Buyer is solely responsible for compliance with all legal and regulatory requirements in connection with such use.

TI has specifically designated certain components as meeting ISO/TS16949 requirements, mainly for automotive use. In any case of use of non-designated products, TI will not be responsible for any failure to meet ISO/TS16949.

Products

| | |
|------------------------------|--------------------------------------------------------------------------------------|
| Audio | www.ti.com/audio |
| Amplifiers | amplifier.ti.com |
| Data Converters | dataconverter.ti.com |
| DLP® Products | www.dlp.com |
| DSP | dsp.ti.com |
| Clocks and Timers | www.ti.com/clocks |
| Interface | interface.ti.com |
| Logic | logic.ti.com |
| Power Mgmt | power.ti.com |
| Microcontrollers | microcontroller.ti.com |
| RFID | www.ti-rfid.com |
| OMAP Applications Processors | www.ti.com/omap |
| Wireless Connectivity | www.ti.com/wirelessconnectivity |

Applications

| | |
|-------------------------------|------------------------------------------------------------------------------------------|
| Automotive and Transportation | www.ti.com/automotive |
| Communications and Telecom | www.ti.com/communications |
| Computers and Peripherals | www.ti.com/computers |
| Consumer Electronics | www.ti.com/consumer-apps |
| Energy and Lighting | www.ti.com/energy |
| Industrial | www.ti.com/industrial |
| Medical | www.ti.com/medical |
| Security | www.ti.com/security |
| Space, Avionics and Defense | www.ti.com/space-avionics-defense |
| Video and Imaging | www.ti.com/video |

TI E2E Community

e2e.ti.com