

Micropower DSBGA 150-mA Ultra Low-Dropout CMOS Voltage Regulator With Sleep MODE

Check for Samples: [LP3987](#)

FEATURES

- Miniature 5-I/O DSBGA Package
- Stable With Ceramic and High-Quality Tantalum Output Capacitors
- Logic Controlled Enable
- Thermal Shutdown and Short-Circuit Current Limit

APPLICATIONS

- CDMA Cellular Handsets
- Wideband CDMA Cellular Handsets
- GSM Cellular Handsets
- Portable Information Appliances
- μ P/DSP Power Supplies
- Digital Cameras
- SRAM Backup

KEY SPECIFICATIONS

- 2.7 to 6.0V Input Range
- 150 mA Output Current
- 1 μ A Quiescent Current on Shutdown
- 100 mV Maximum Dropout with 150 mA Load
- 50dB PSRR at 10KHz
- Sleep MODE Features
- Over Temperature & Over Current Protection
- -40°C to +125°C Junction Temperature Range for Operation

DESCRIPTION

The LP3987 is a 150mA fixed output voltage regulator with very low dropout voltage designed specially to meet requirements of battery-powered applications. The additional sleep MODE feature will reduce current consumption during standby operation to prolong the usage of battery.

Dropout Voltage: 100mV maximum dropout with 150mA load.

Shutdown: Less than 1 μ A quiescent current.

Sleep Mode: Typically 14 μ A quiescent current during sleep MODE to reduce battery consumption.

Enhanced Stability: The LP3987 is stable with minimum 1 μ F \pm 20% low ESR ceramic output capacitor as low as 5m Ω and high quality tantalum capacitors.

The LP3987 is available in a thin 5 Bump DSBGA package. Performance is specified for -40°C to 125°C.

This device is available with output voltage options of 2.5V, 2.6V, 2.8V, 2.85V, and 3.0V. For other voltage options, please contact Texas Instruments.

Typical Application Circuit

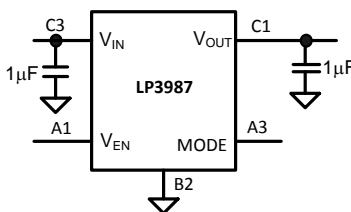

Please be aware that an important notice concerning availability, standard warranty, and use in critical applications of Texas Instruments semiconductor products and disclaimers thereto appears at the end of this data sheet.

All trademarks are the property of their respective owners.

Block Diagram

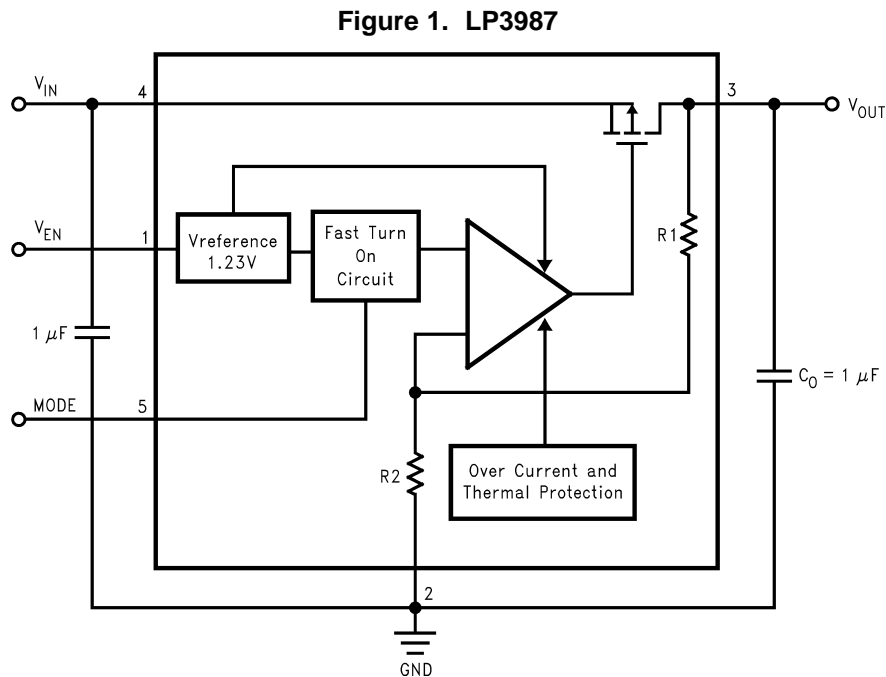

Connection Diagram

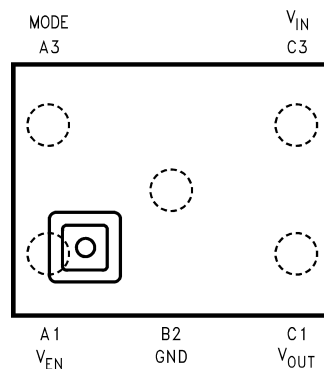

**Figure 2. Top View
5 I/O DSBGA Package
See Package Number YZR0005ADA**

PIN DESCRIPTIONS

Name	Pin ⁽¹⁾	Function
V _{EN}	A1	Enable Input Logic, Enable High
GND	B2	Common Ground
V _{OUT}	C1	Output voltage of the LDO
V _{IN}	C3	Input voltage of the LDO
MODE	A3	Power Mode Control, Active = 1, Sleep Mode = 0

(1) The pin numbering scheme for the DSBGA package was revised in April, 2002 to conform to JEDEC standard. Only the pin numbers were revised. No changes to the physical location of the inputs/outputs were made. For reference purposes, the obsolete numbering scheme had VEN as pin 1, GND as pin 2, VOUT as pin 3, VIN as pin 4, and MODE as pin 5.

ORDERING INFORMATION⁽¹⁾⁽²⁾

DSBGA Package			
Output Voltage	Grade	LP3987 Supplied as 250 Units Tape and Reel	LP3987 Supplied as 3000 Units Tape and Reel
2.5V	STD	LP3987ITL-2.5	LP3987ITLX-2.5
2.6V		LP3987ITL-2.6	LP3987ITLX-2.6
2.8V		LP3987ITL-2.8	LP3987ITLX-2.8
2.85V		LP3987ITL-2.85	LP3987ITLX-2.5
3.0V		LP3987ITL-3.0	LP3987ITLX-3.0

- (1) For the most current package and ordering information, see the Package Option Addendum at the end of this document, or see the TI web site at www.ti.com.
- (2) Package drawings, thermal data, and symbolization are available at www.ti.com/packaging.



These devices have limited built-in ESD protection. The leads should be shorted together or the device placed in conductive foam during storage or handling to prevent electrostatic damage to the MOS gates.

Absolute Maximum Ratings⁽¹⁾⁽²⁾⁽³⁾

V_{IN}		-0.3 to 6.5V
V_{EN}, V_{MODE}		-0.3 to 6.5V
V_{OUT}		-0.3V to $(V_{IN} + 0.3V) \leq 6.5$
Storage Temperature		-65°C to +150°C
ESD ⁽⁴⁾	Human Body Model	2KV
	Machine Model	200V
Maximum Power Dissipation ⁽⁵⁾	θ_{JA} (DSBGA small bump)	255°C/W

- (1) Stresses beyond those listed under absolute maximum ratings may cause permanent damage to the device. These are stress ratings only, and functional operation of the device at these or any other conditions beyond those indicated under recommended operating conditions is not implied. Exposure to absolute-maximum-rated conditions for extended periods may affect device reliability.
- (2) All voltages are with respect to the potential at the GND pin.
- (3) If Military/Aerospace specified devices are required, please contact the TI Sales Office/Distributors for availability and specifications.
- (4) The human body model is 100pF discharged through 1.5k Ω .
- (5) The Absolute Maximum power dissipation depends on the ambient temperature and can be calculated using the formula: $P_D = (T_J - T_A) / \theta_{JA}$. Where T_J is the junction temperature, T_A is the ambient temperature, and θ_{JA} is the junction-to-ambient thermal resistance. For instant, if V_{IN} in target application is 4.2V and worse case current consumption is 90mA. Therefore $P_{MAX_DISSIPATION} = (4.2 - 2.7) * 0.09 = 135mW$. With $P_{MAX_DISSIPATION}$ is 135mW, T_{Jmax} is 125°C and worse case ambient temperature (T_A) in target application is 85°C, $\theta_{JA} = (125 - 85) / 0.135 = 296^\circ C/W$.

Operating Ratings⁽¹⁾⁽²⁾

V_{IN}	$V_{OUT} + 200mV$ to 6V
V_{EN}, V_{MODE}	0 to 6.0V
Junction Temperature	-40°C to +125°C
Maximum Power Dissipation ⁽³⁾	392mW at 25°C

- (1) Stresses beyond those listed under absolute maximum ratings may cause permanent damage to the device. These are stress ratings only, and functional operation of the device at these or any other conditions beyond those indicated under recommended operating conditions is not implied. Exposure to absolute-maximum-rated conditions for extended periods may affect device reliability.
- (2) All voltages are with respect to the potential at the GND pin.
- (3) The Absolute Maximum power dissipation depends on the ambient temperature and can be calculated using the formula: $P_D = (T_J - T_A) / \theta_{JA}$. Where T_J is the junction temperature, T_A is the ambient temperature, and θ_{JA} is the junction-to-ambient thermal resistance. For instant, if V_{IN} in target application is 4.2V and worse case current consumption is 90mA. Therefore $P_{MAX_DISSIPATION} = (4.2 - 2.7) * 0.09 = 135mW$. With $P_{MAX_DISSIPATION}$ is 135mW, T_{Jmax} is 125°C and worse case ambient temperature (T_A) in target application is 85°C, $\theta_{JA} = (125 - 85) / 0.135 = 296^\circ C/W$.

Electrical Characteristics

Unless otherwise specified: $V_{EN} = 1.8V$, $MODE = 1.8V$, $V_{IN} = V_{OUT(nom)} + 0.5V$, $C_{IN} = 1 \mu F$, $I_{OUT} = 1mA$, $C_{OUT} = 1 \mu F$.

Typical values and limits appearing in standard typeface are for $T_J = 25^\circ C$. Limits appearing in **boldface type** apply over the entire junction temperature range for operation, $-40^\circ C$ to $+125^\circ C$. ⁽¹⁾ ⁽²⁾

Parameter	Test Conditions	Typ	Limit		Unit
			Min	Max	
ΔV_{OUT}	Output Voltage Tolerance	$I_{OUT} = 1mA, 25^\circ C$	-2	2	% of $V_{OUT(nom)}$
		$I_{OUT} = 1mA$	-3	3	
	Line Regulation Error	$V_{IN} = (V_{OUT(nom)} + 0.5V)$ to 6.0V, $I_{OUT} = 1mA$	-0.1	0.1	%/V
	Load Regulation Error	$I_{OUT} = 1mA$ to 150 mA	0.0004	0.002	%/mA
Dropout Voltage ⁽³⁾	$I_{OUT} = 1mA$	0.4		2	mV
	$I_{OUT} = 150mA$	60		100	
$\Delta V_{OUT(SLEEP)}$	Output Voltage difference at $MODE = 0V$	$MODE = 0V$, ⁽⁴⁾	-150	+100	mV
Transient Response	Line Transient Response ⁽⁵⁾	$MODE = 1.8V, I_{LOAD} = 100mA, T_{RISE} = T_{FALL} = 10\mu S, V_{IN} = 600mV$ P-P AC Square wave, ⁽⁶⁾	21		mVpp
	Load Transient Response ⁽⁵⁾	$MODE = 1.8V, C_{OUT} = 4.7\mu F, T_{RISE} = T_{FALL} = 100nS, V_{IN} = 3.1V, 3.6V, 4.2V$, ⁽⁷⁾ ⁽⁸⁾	100		mVpk
PSRR	Power Supply Rejection Ratio ⁽⁵⁾	$V_{IN} = V_{OUT(nom)} + 1V, MODE = 1.8V, f < 10kHz, I_{OUT} = 1mA$	50		dB
		$V_{IN} = V_{OUT(nom)} + 1V, MODE = 0V, f < 10kHz, I_{OUT} = 1mA$	10		
$I_{Q(ON)}$	Quiescent Current	$MODE = 1.8V, I_{OUT} = 0mA, V_{IN} = 4.2V$	85	120	μA
		$MODE = 1.8V, I_{OUT} = 150mA, V_{IN} = 4.2V$	160	200	
$I_{Q(OFF)}$	Quiescent Current	$ENABLE = 0V, V_{IN} = 4.2V$	1	3	μA
$I_{Q(SLEEP)}$	Current in Standby Mode	$MODE = 0V, I_{OUT} = 50\mu A, V_{IN} = 4.2V$	14	21	μA
I_{SC}	Short Circuit Current Limit ⁽⁵⁾	Output Grounded	600		mA
$I_{SC(SLEEP)}$	Short Circuit Current in Sleep MODE	Output Grounded	28	43	mA
$I_{OUT(ON)}$	Maximum Output Current at $MODE = 1.8V$	$MODE = 1.8V$		150	mA
$I_{OUT(SLEEP)}$	Maximum Output Current at $MODE = 0V$	$MODE = 0V$		3	mA
e_n	Output Noise Voltage ⁽⁵⁾	$BW = 10Hz$ to 100 kHz, $C_{OUT} = 1\mu F$	70		μV_{rms}
$T_{SHUTDOWN}$	Shutdown Temperature ⁽⁵⁾	Sleep $MODE = 1.8V$	155		$^\circ C$
Logic Control Characteristics					
I_{EN}	Maximum Input Current at EN	$V_{EN} = 0$ and $V_{IN} = 6.0V$	0.015		μA
V_{IL}	Logic Low Input Threshold	$V_{IN} = 3.05$ to 6V		0.5	V
V_{IH}	Logic High Input Threshold	$V_{IN} = 3.05$ to 6V		1.2	V

- (1) Min and Max Limits are verified by design, test, or statistical analysis. Typical (Typ.) numbers are not verified, but do represent the most likely norm.
- (2) The nominal output voltage, which is labeled $V_{OUT(nom)}$, is the output voltage measured with the input 0.5V above $V_{OUT(nom)}$ and a 1mA load.
- (3) Dropout voltage is defined as the input to output voltage differential at which the output voltage falls to 100mV below the nominal output voltage. V_{IN} less than minimum operating voltage may be used for test purposes.
- (4) On/Sleep Mode voltage tolerance and current capability requirement. See [Figure 3](#).
- (5) This electrical specification is specified by design.
- (6) Line Transient response requirement. See [Figure 4](#).
- (7) Load Transient response requirement. See [Figure 5](#).
- (8) During transient recovery, output voltage should not be oscillating.

Electrical Characteristics (continued)

Unless otherwise specified: $V_{EN} = 1.8V$, $MODE = 1.8V$, $V_{IN} = V_{OUT(nom)} + 0.5V$, $C_{IN} = 1 \mu F$, $I_{OUT} = 1mA$, $C_{OUT} = 1 \mu F$.

Typical values and limits appearing in standard typeface are for $T_J = 25^\circ C$. Limits appearing in **boldface type** apply over the entire junction temperature range for operation, $-40^\circ C$ to $+125^\circ C$. ⁽¹⁾ ⁽²⁾

Parameter	Test Conditions	Typ	Limit		Unit
			Min	Max	
V_{MODE_L}	Logic Low Input Threshold	$V_{IN} = 3.05$ to $6V$		0.5	V
V_{MODE_H}	Logic High Input Threshold	$V_{IN} = 3.05$ to $6V$		1.2	V
I_{MODE}	Maximum Input Current at V_{MODE}	$V_{MODE} = 0$ and $V_{IN} = 6.0V$	0.015		μA
Timing Characteristics					
T_{ON}	Turn on Time (On Mode) ⁽⁵⁾ ⁽⁹⁾	$MODE = 1.8V$, $C_{OUT} = 4.7\mu F$	170	250	μs
T_{SLEEP}	Turn on Time (Sleep Mode) ⁽⁵⁾ ⁽¹⁰⁾	$MODE = 0V$, $C_{OUT} = 4.7\mu F$	0.5	5	ms
T_{MODE}	Sleep to On Mode Settle Time ⁽⁵⁾ ⁽¹¹⁾	$C_{OUT} = 4.7\mu F$, Enable = $1.8V$	200	300	μs

(9) T_{ON} is measured from rising edge of Enable with $MODE = 1.8V$ to when V_{OUT} reaches 95% of final value.

(10) T_{SLEEP} is measured from rising edge of Enable with $MODE = 0V$ to when V_{OUT} reaches 95% of final value.

(11) T_{MODE} is measured from rising edge of MODE with $ENABLE = 1.8V$ to time before full current capability.

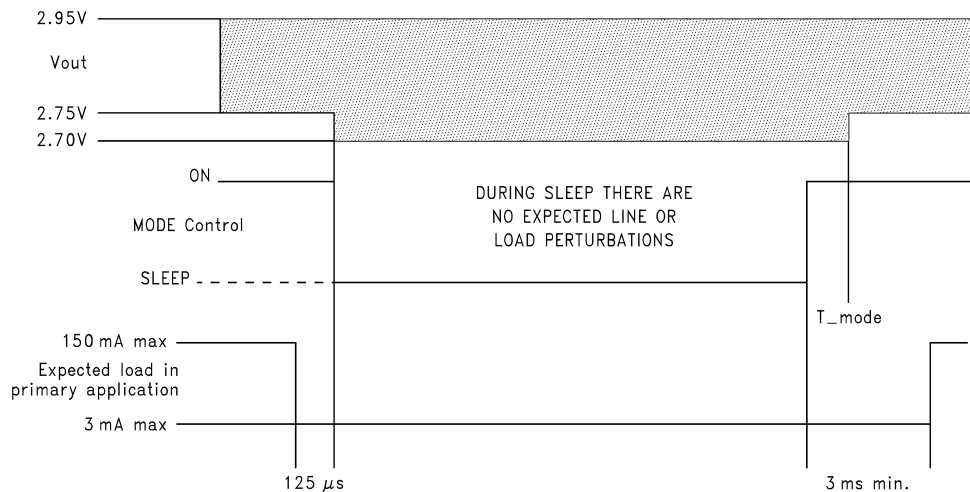

Figure 3.

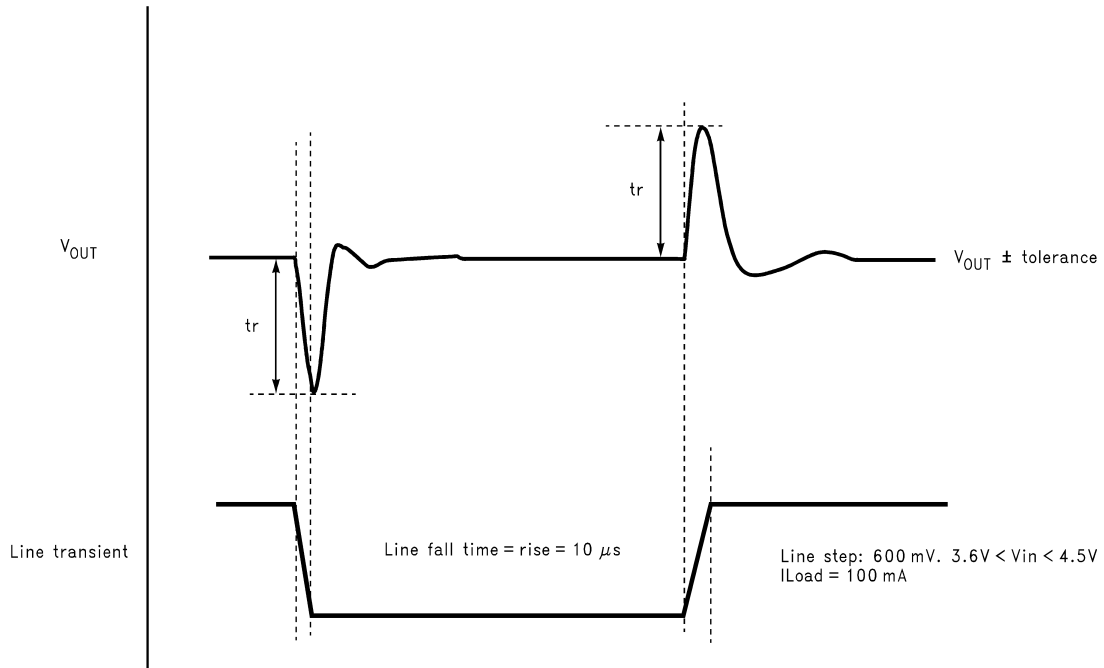

Figure 4.

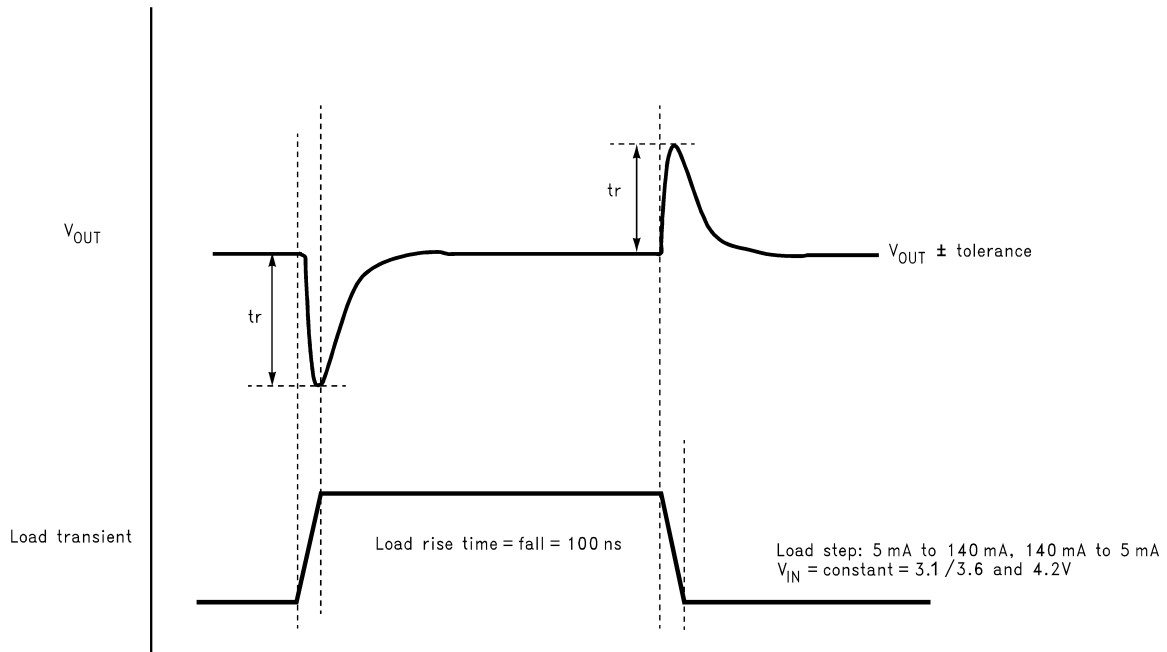

Figure 5.

Typical Performance Characteristics

Unless otherwise specified, $C_{IN} = C_{OUT} = 1 \mu\text{F}$ Ceramic, $V_{IN} = V_{OUT(nom)} + 0.5\text{V}$, $T_A = 25^\circ\text{C}$, Enable pin is tied to V_{IN} , MODE = 1.8V.

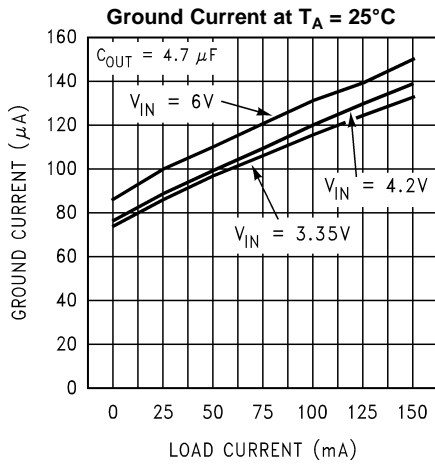

Figure 6.

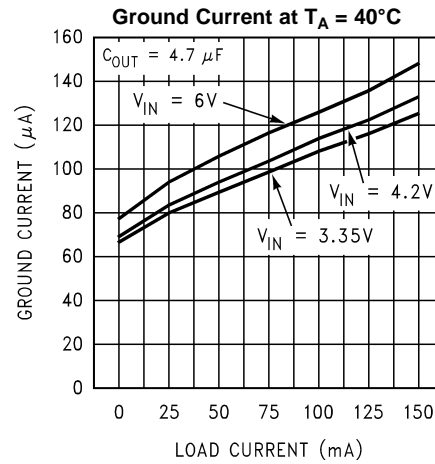

Figure 7.

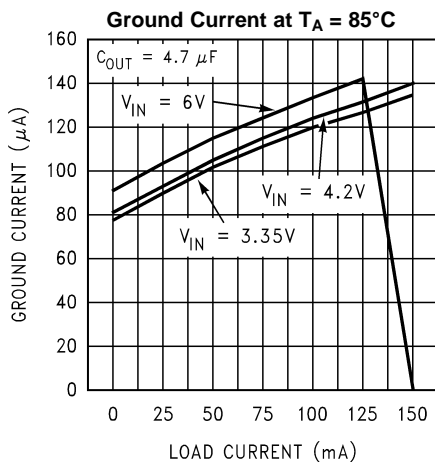

Figure 8.

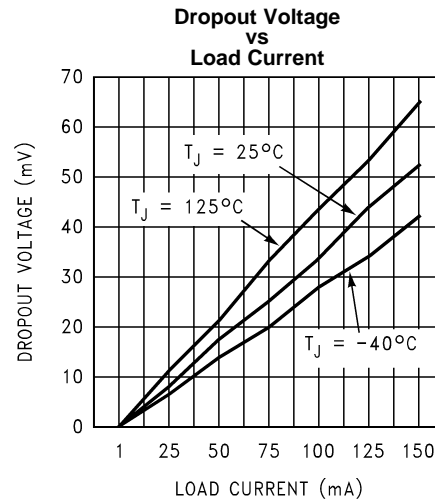

Figure 9.

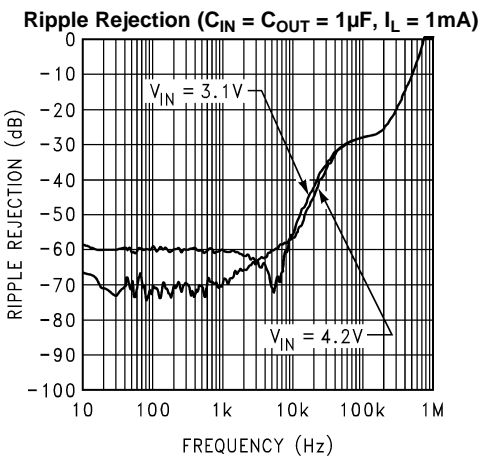

Figure 10.

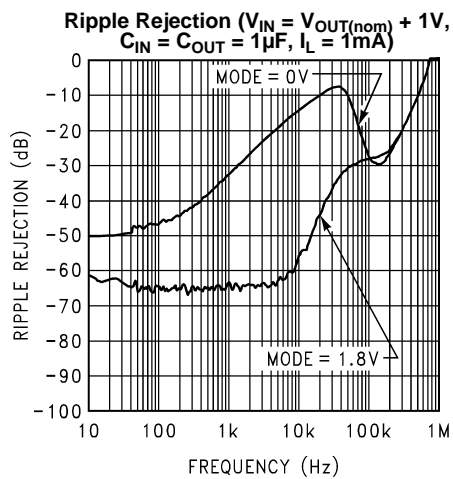

Figure 11.

Typical Performance Characteristics (continued)

Unless otherwise specified, $C_{IN} = C_{OUT} = 1 \mu\text{F}$ Ceramic, $V_{IN} = V_{OUT(nom)} + 0.5\text{V}$, $T_A = 25^\circ\text{C}$, Enable pin is tied to V_{IN} , $\text{MODE} = 1.8\text{V}$.

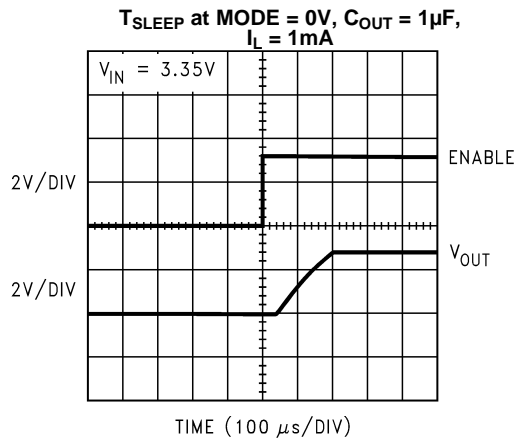

Figure 12.

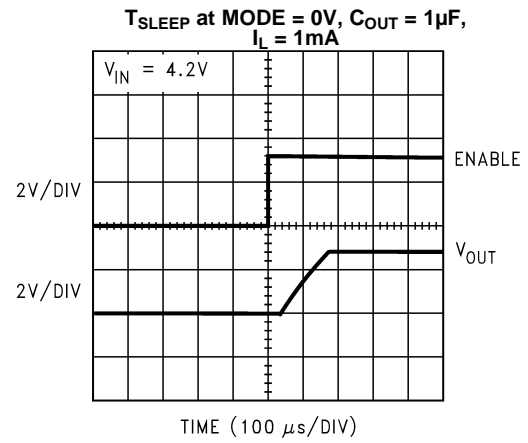

Figure 13.

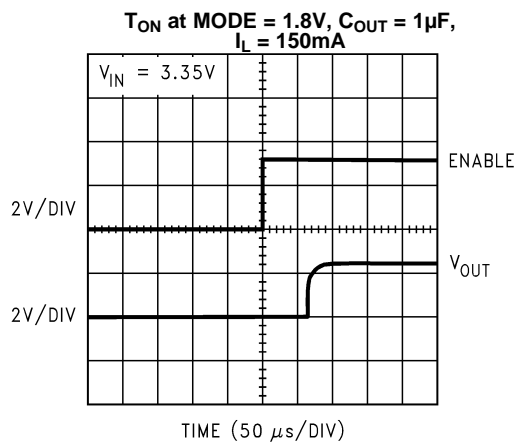

Figure 14.

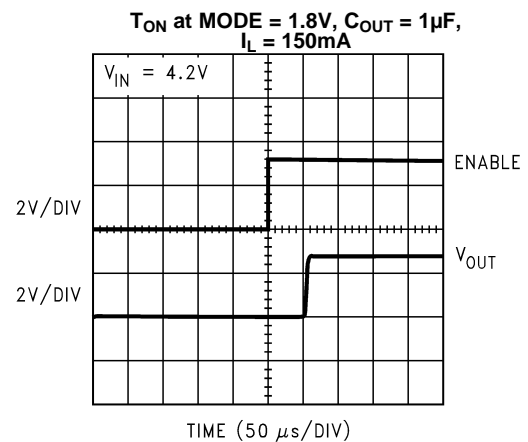

Figure 15.

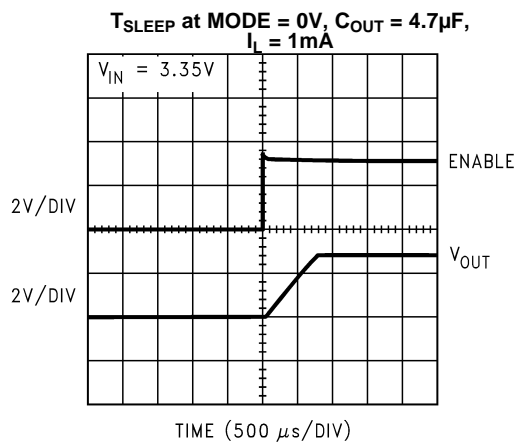

Figure 16.

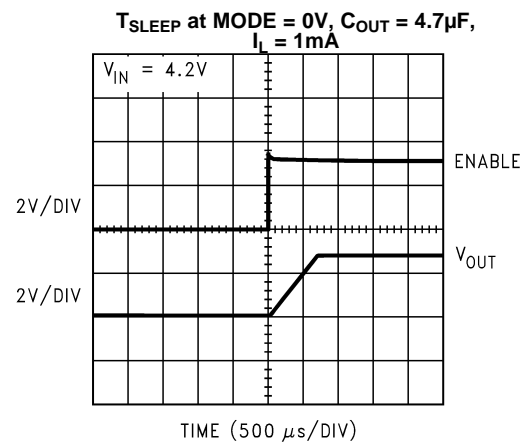
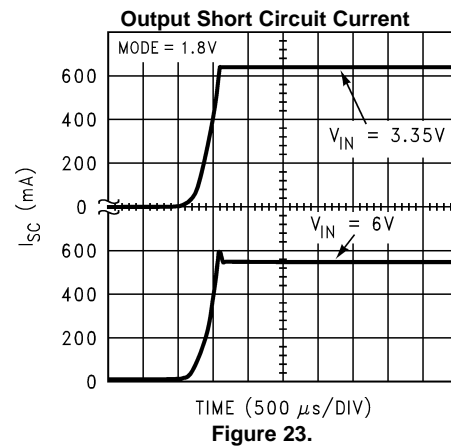
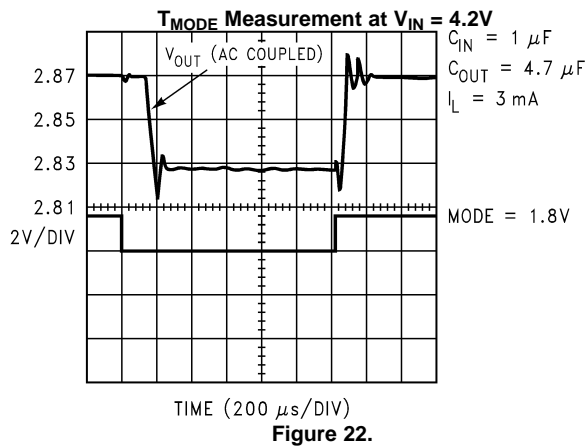
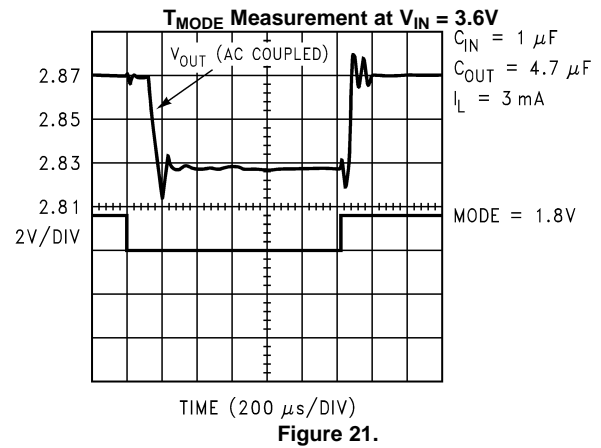
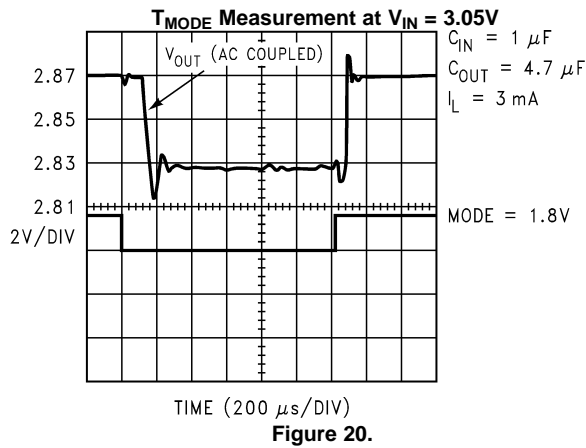
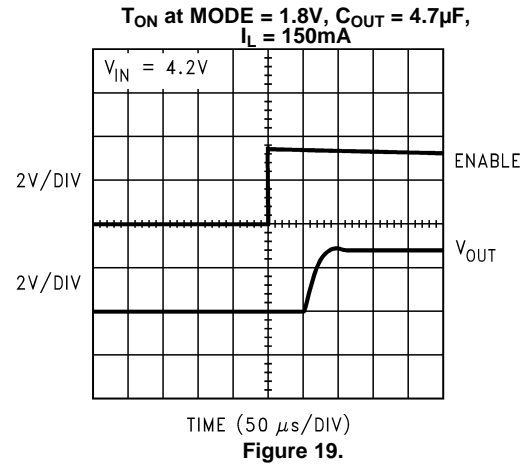
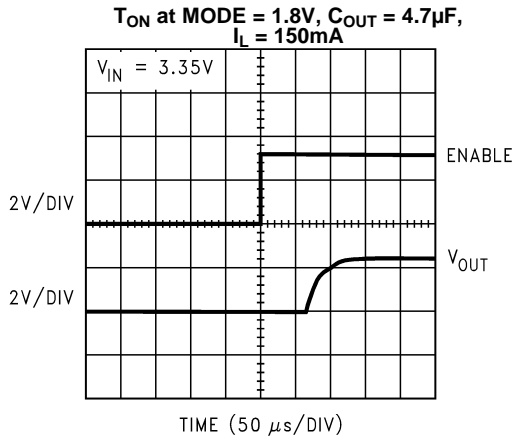

Figure 17.

Typical Performance Characteristics (continued)

Unless otherwise specified, $C_{IN} = C_{OUT} = 1 \mu F$ Ceramic, $V_{IN} = V_{OUT(nom)} + 0.5V$, $T_A = 25^\circ C$, Enable pin is tied to V_{IN} , MODE = 1.8V.



Typical Performance Characteristics (continued)

Unless otherwise specified, $C_{IN} = C_{OUT} = 1 \mu F$ Ceramic, $V_{IN} = V_{OUT(nom)} + 0.5V$, $T_A = 25^\circ C$, Enable pin is tied to V_{IN} , MODE = 1.8V.

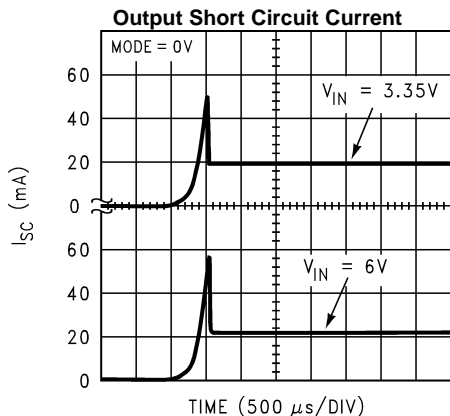

Figure 24.

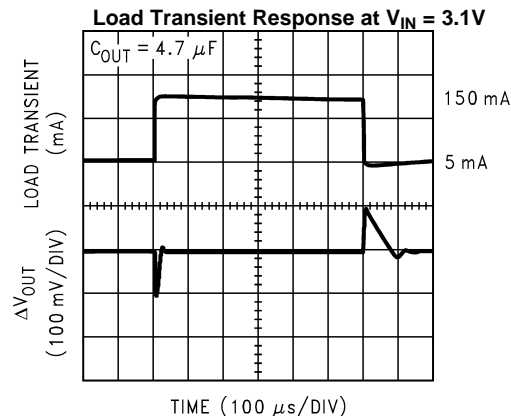

Figure 25.

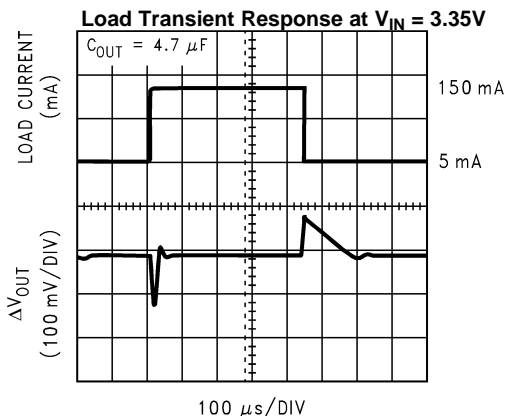

Figure 26.

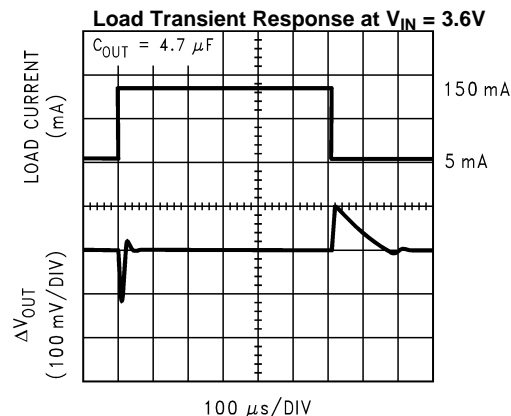

Figure 27.

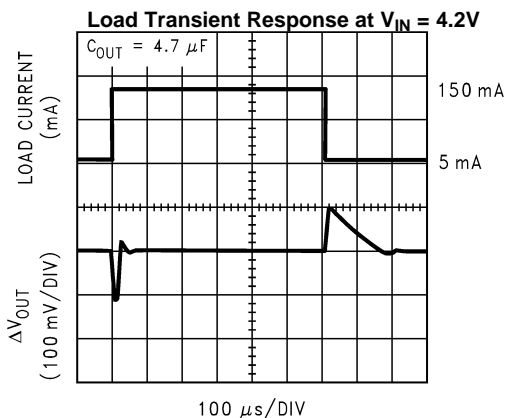

Figure 28.

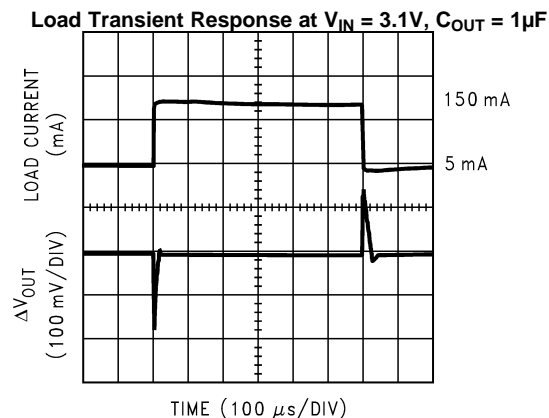

Figure 29.

Typical Performance Characteristics (continued)

Unless otherwise specified, $C_{IN} = C_{OUT} = 1 \mu\text{F}$ Ceramic, $V_{IN} = V_{OUT(nom)} + 0.5\text{V}$, $T_A = 25^\circ\text{C}$, Enable pin is tied to V_{IN} , MODE = 1.8V.

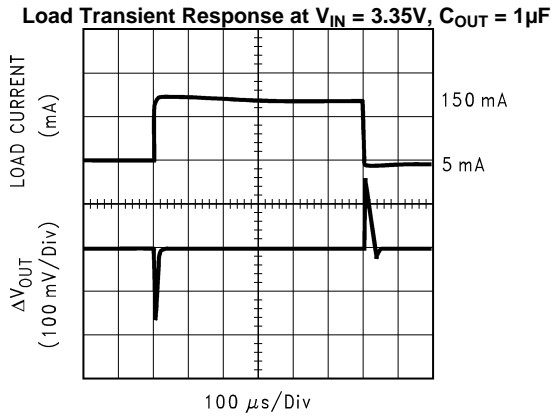

Figure 30.

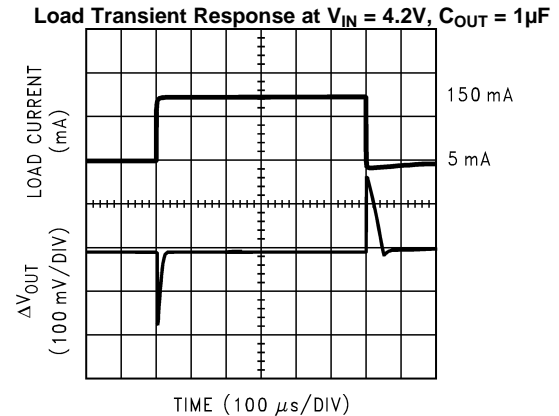

Figure 31.

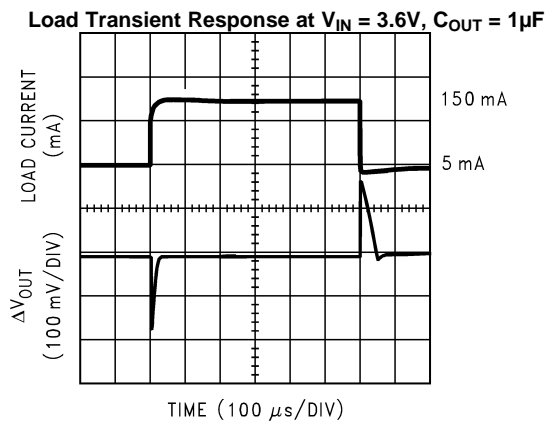

Figure 32.

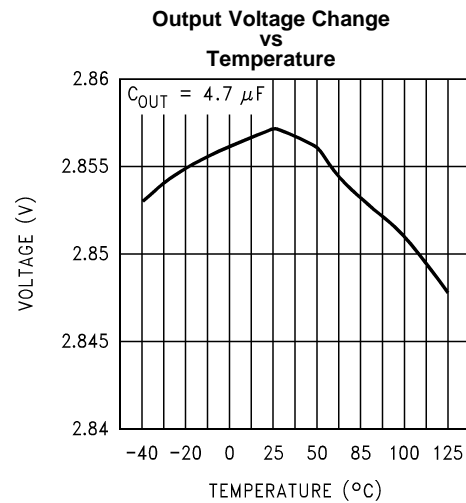

Figure 33.

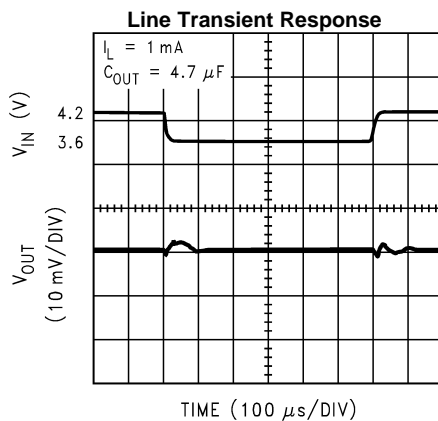

Figure 34.

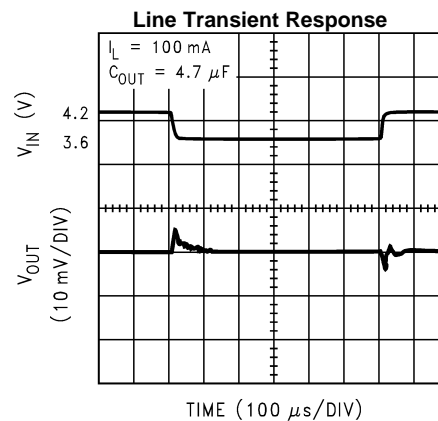

Figure 35.

Typical Performance Characteristics (continued)

Unless otherwise specified, $C_{IN} = C_{OUT} = 1 \mu\text{F}$ Ceramic, $V_{IN} = V_{OUT(nom)} + 0.5\text{V}$, $T_A = 25^\circ\text{C}$, Enable pin is tied to V_{IN} , MODE = 1.8V.

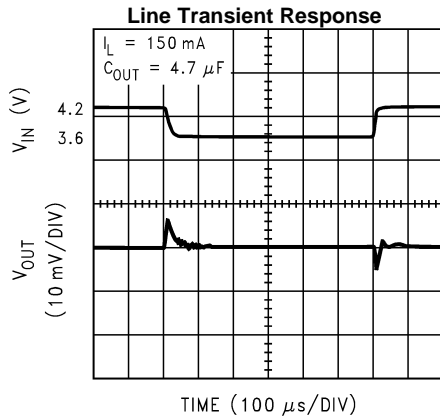

Figure 36.

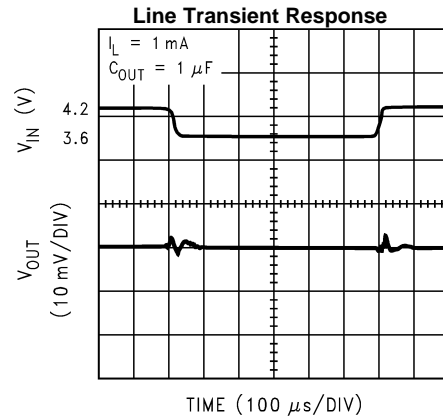

Figure 37.

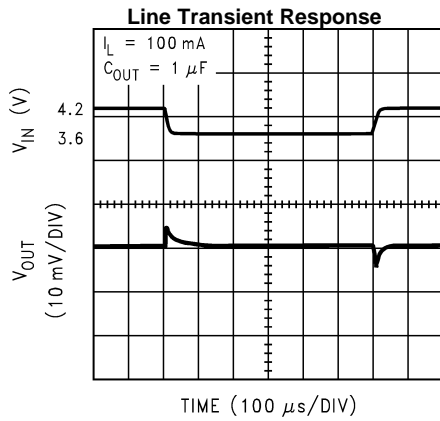

Figure 38.

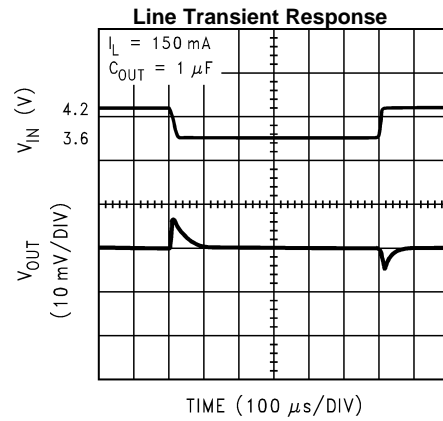

Figure 39.

APPLICATION HINTS

EXTERNAL CAPACITORS

Like any low-dropout regulator, the LP3987 requires external capacitors for regulator stability. The LP3987 is specifically designed for portable applications requiring minimum board space and smallest components. These capacitors must be correctly selected for good performance.

INPUT CAPACITOR

An input capacitance of $\approx 1\mu\text{F}$ is required between the LP3987 input pin and ground (the amount of the capacitance may be increased without limit).

This capacitor must be located a distance of not more than 1cm from the input pin and returned to a clean analog ground. Any good quality ceramic, tantalum, or film capacitor may be used at the input.

Important: Tantalum capacitors can suffer catastrophic failures due to surge current when connected to a low-impedance source of power (like a battery or a very large capacitor). If a tantalum capacitor is used at the input, it must be specified by the manufacturer to have a surge current rating sufficient for the application.

There are no requirements for the ESR on the input capacitor, but tolerance and temperature coefficient must be considered when selecting the capacitor to ensure the capacitance will be $\approx 1\mu\text{F}$ over the entire operating temperature range.

OUTPUT CAPACITOR

The LP3987 is designed specifically to work with very small ceramic output capacitors. A ceramic capacitor (dielectric types Z5U, Y5V or X7R) in 1 to 4.7 μF range with 5m Ω to 500m Ω ESR range is suitable in the LP3987 application circuit.

It may also be possible to use tantalum or film capacitors at the output, but these are not as attractive for reasons of size and cost (see next section Capacitor Characteristics).

The output capacitor must meet the requirement for minimum amount of capacitance and also have an ESR (Equivalent Series Resistance) value which is within a stable range (5 m Ω to 500 m Ω).

NO-LOAD STABILITY

The LP3987 will remain stable and in regulation with no external load. This is specially important in CMOS RAM keep-alive applications.

CAPACITOR CHARACTERISTICS

The LP3987 is designed to work with ceramic capacitors on the output to take advantage of the benefits they offer: for capacitance values in the range of 1 μF to 4.7 μF range, ceramic capacitors are the smallest, least expensive and have the lowest ESR values (which makes them best for eliminating high frequency noise). The ESR of a typical 1 μF ceramic capacitor is in the range of 20 m Ω to 40 m Ω , which easily meets the ESR requirement for stability by the LP3987. The ceramic capacitor's capacitance can vary with temperature. Most large value ceramic capacitors ($\approx 2.2\mu\text{F}$) are manufactured with Z5U or Y5V temperature characteristics, which results in the capacitance dropping by more than 50% as the temperature goes from 25°C to 85°C.

A better choice for temperature coefficient in a ceramic capacitor is X7R, which holds the capacitance within $\pm 15\%$. Tantalum capacitors are less desirable than ceramic for use as output capacitors because they are more expensive when comparing equivalent capacitance and voltage ratings in the 1 μF to 4.7 μF range.

Another important consideration is that tantalum capacitors have higher ESR values than equivalent size ceramics. This means that while it may be possible to find a tantalum capacitor with an ESR value within the stable range, it would have to be larger in capacitance (which means bigger and more costly) than a ceramic capacitor with the same ESR value. It should also be noted that the ESR of a typical tantalum will increase about 2:1 as the temperature goes from 25°C down to -40°C, so some guard band must be allowed.

ON/OFF INPUT OPERATION

The LP3987 is turned off by pulling the V_{EN} pin low, and turned on by pulling it high. If this feature is not used, the V_{EN} pin should be tied to V_{IN} to keep the regulator output on at all time. To assure proper operation, the signal source used to drive the V_{EN} input must be able to swing above and below the specified turn-on/off voltage thresholds listed in the Electrical Characteristics section under V_{IL} and V_{IH} .

MODE OPERATION

The LP3987 enters sleep mode by pulling $MODE = 0V$ externally to reduce current during standby operation. During sleep mode, LP3987 consumes only $14\mu A$ of quiescent current and supplies up to $3mA$ of current. The device returns to active mode by pulling $MODE = 1.8V$. If this function is not used, the $MODE$ pin should be tied to V_{IN} .

THERMAL PROTECTION

The LP3987 has internal thermal protection circuitry to disable the internal pass transistor if the junction temperature exceeds $125^{\circ}C$ to allow the device to cool down. The pass transistor will turn on when temperature falls below the maximum operating junction temperature of $125^{\circ}C$. This feature is designed to protect the device in the event of fault conditions. For normal operation, it is suggested to limit the device junction temperature to less than $125^{\circ}C$.

DSBGA MOUNTING

The DSBGA package requires specific mounting techniques which are detailed in Texas Instruments AN-1112 Application Report ([SNOA401](#)). Referring to the section *PCB Layout*, note that the pad style which must be used with the 5 pin package is NSMD (non-solder mask defined) type.

For best results during assembly, alignment ordinals on the PC board may be used to facilitate placement of the DSBGA device.

DSBGA LIGHT SENSITIVITY

Exposing the DSBGA device to direct sunlight will cause misoperation of the device. Light sources such as Halogen lamps can effect electrical performance if brought near to the device. The wavelengths which have most detrimental effect are reds and infra-reds, which means that the fluorescent lighting used inside most buildings has very little effect on performance. A DSBGA test board was brought to within 1cm of a fluorescent desk lamp and the effect on the regulated output voltage was negligible, showing a deviation of less than 0.1% from nominal.

REVISION HISTORY

Changes from Revision F (May 2013) to Revision G	Page
• Changed layout of National Data Sheet to TI format	14

PACKAGING INFORMATION

Orderable Device	Status (1)	Package Type	Package Drawing	Pins	Package Qty	Eco Plan (2)	Lead/Ball Finish	MSL Peak Temp (3)	Op Temp (°C)	Top-Side Markings (4)	Samples
LP3987ITL-2.5/NOPB	ACTIVE	DSBGA	YZR	5	250	Green (RoHS & no Sb/Br)	SNAGCU	Level-1-260C-UNLIM		7	Samples
LP3987ITL-2.6/NOPB	ACTIVE	DSBGA	YZR	5	250	Green (RoHS & no Sb/Br)	SNAGCU	Level-1-260C-UNLIM	-40 to 125	7	Samples
LP3987ITL-2.8/NOPB	ACTIVE	DSBGA	YZR	5	250	Green (RoHS & no Sb/Br)	SNAGCU	Level-1-260C-UNLIM	-40 to 125	7	Samples
LP3987ITL-2.85/NOPB	ACTIVE	DSBGA	YZR	5	250	Green (RoHS & no Sb/Br)	SNAGCU	Level-1-260C-UNLIM	-40 to 125	7	Samples
LP3987ITL-3.0/NOPB	ACTIVE	DSBGA	YZR	5	250	Green (RoHS & no Sb/Br)	SNAGCU	Level-1-260C-UNLIM		7	Samples
LP3987ITLX-2.5/NOPB	ACTIVE	DSBGA	YZR	5	3000	Green (RoHS & no Sb/Br)	SNAGCU	Level-1-260C-UNLIM		7	Samples
LP3987ITLX-2.6/NOPB	ACTIVE	DSBGA	YZR	5	3000	Green (RoHS & no Sb/Br)	SNAGCU	Level-1-260C-UNLIM	-40 to 125	7	Samples
LP3987ITLX-2.8/NOPB	ACTIVE	DSBGA	YZR	5	3000	Green (RoHS & no Sb/Br)	SNAGCU	Level-1-260C-UNLIM	-40 to 125	7	Samples
LP3987ITLX-2.85/NOPB	ACTIVE	DSBGA	YZR	5	3000	Green (RoHS & no Sb/Br)	SNAGCU	Level-1-260C-UNLIM	-40 to 125	7	Samples
LP3987ITLX-3.0/NOPB	ACTIVE	DSBGA	YZR	5	3000	Green (RoHS & no Sb/Br)	SNAGCU	Level-1-260C-UNLIM		7	Samples

(1) The marketing status values are defined as follows:

ACTIVE: Product device recommended for new designs.

LIFEBUY: TI has announced that the device will be discontinued, and a lifetime-buy period is in effect.

NRND: Not recommended for new designs. Device is in production to support existing customers, but TI does not recommend using this part in a new design.

PREVIEW: Device has been announced but is not in production. Samples may or may not be available.

OBSOLETE: TI has discontinued the production of the device.

(2) Eco Plan - The planned eco-friendly classification: Pb-Free (RoHS), Pb-Free (RoHS Exempt), or Green (RoHS & no Sb/Br) - please check <http://www.ti.com/productcontent> for the latest availability information and additional product content details.

TBD: The Pb-Free/Green conversion plan has not been defined.

Pb-Free (RoHS): TI's terms "Lead-Free" or "Pb-Free" mean semiconductor products that are compatible with the current RoHS requirements for all 6 substances, including the requirement that lead not exceed 0.1% by weight in homogeneous materials. Where designed to be soldered at high temperatures, TI Pb-Free products are suitable for use in specified lead-free processes.

Pb-Free (RoHS Exempt): This component has a RoHS exemption for either 1) lead-based flip-chip solder bumps used between the die and package, or 2) lead-based die adhesive used between the die and leadframe. The component is otherwise considered Pb-Free (RoHS compatible) as defined above.

Green (RoHS & no Sb/Br): TI defines "Green" to mean Pb-Free (RoHS compatible), and free of Bromine (Br) and Antimony (Sb) based flame retardants (Br or Sb do not exceed 0.1% by weight in homogeneous material)

(3) MSL, Peak Temp. -- The Moisture Sensitivity Level rating according to the JEDEC industry standard classifications, and peak solder temperature.

(4) Multiple Top-Side Markings will be inside parentheses. Only one Top-Side Marking contained in parentheses and separated by a "~" will appear on a device. If a line is indented then it is a continuation of the previous line and the two combined represent the entire Top-Side Marking for that device.

Important Information and Disclaimer:The information provided on this page represents TI's knowledge and belief as of the date that it is provided. TI bases its knowledge and belief on information provided by third parties, and makes no representation or warranty as to the accuracy of such information. Efforts are underway to better integrate information from third parties. TI has taken and continues to take reasonable steps to provide representative and accurate information but may not have conducted destructive testing or chemical analysis on incoming materials and chemicals. TI and TI suppliers consider certain information to be proprietary, and thus CAS numbers and other limited information may not be available for release.

In no event shall TI's liability arising out of such information exceed the total purchase price of the TI part(s) at issue in this document sold by TI to Customer on an annual basis.

TAPE AND REEL INFORMATION

QUADRANT ASSIGNMENTS FOR PIN 1 ORIENTATION IN TAPE

*All dimensions are nominal

Device	Package Type	Package Drawing	Pins	SPQ	Reel Diameter (mm)	Reel Width W1 (mm)	A0 (mm)	B0 (mm)	K0 (mm)	P1 (mm)	W (mm)	Pin1 Quadrant
LP3987ITL-2.5/NOPB	DSBGA	YZR	5	250	178.0	8.4	1.09	1.55	0.76	4.0	8.0	Q1
LP3987ITL-2.6/NOPB	DSBGA	YZR	5	250	178.0	8.4	1.09	1.55	0.76	4.0	8.0	Q1
LP3987ITL-2.8/NOPB	DSBGA	YZR	5	250	178.0	8.4	1.09	1.55	0.76	4.0	8.0	Q1
LP3987ITL-2.85/NOPB	DSBGA	YZR	5	250	178.0	8.4	1.09	1.55	0.76	4.0	8.0	Q1
LP3987ITL-3.0/NOPB	DSBGA	YZR	5	250	178.0	8.4	1.09	1.55	0.76	4.0	8.0	Q1
LP3987ITLX-2.5/NOPB	DSBGA	YZR	5	3000	178.0	8.4	1.09	1.55	0.76	4.0	8.0	Q1
LP3987ITLX-2.6/NOPB	DSBGA	YZR	5	3000	178.0	8.4	1.09	1.55	0.76	4.0	8.0	Q1
LP3987ITLX-2.8/NOPB	DSBGA	YZR	5	3000	178.0	8.4	1.09	1.55	0.76	4.0	8.0	Q1
LP3987ITLX-2.85/NOPB	DSBGA	YZR	5	3000	178.0	8.4	1.09	1.55	0.76	4.0	8.0	Q1
LP3987ITLX-3.0/NOPB	DSBGA	YZR	5	3000	178.0	8.4	1.09	1.55	0.76	4.0	8.0	Q1

TAPE AND REEL BOX DIMENSIONS

*All dimensions are nominal

Device	Package Type	Package Drawing	Pins	SPQ	Length (mm)	Width (mm)	Height (mm)
LP3987ITL-2.5/NOPB	DSBGA	YZR	5	250	210.0	185.0	35.0
LP3987ITL-2.6/NOPB	DSBGA	YZR	5	250	210.0	185.0	35.0
LP3987ITL-2.8/NOPB	DSBGA	YZR	5	250	210.0	185.0	35.0
LP3987ITL-2.85/NOPB	DSBGA	YZR	5	250	210.0	185.0	35.0
LP3987ITL-3.0/NOPB	DSBGA	YZR	5	250	210.0	185.0	35.0
LP3987ITLX-2.5/NOPB	DSBGA	YZR	5	3000	210.0	185.0	35.0
LP3987ITLX-2.6/NOPB	DSBGA	YZR	5	3000	210.0	185.0	35.0
LP3987ITLX-2.8/NOPB	DSBGA	YZR	5	3000	210.0	185.0	35.0
LP3987ITLX-2.85/NOPB	DSBGA	YZR	5	3000	210.0	185.0	35.0
LP3987ITLX-3.0/NOPB	DSBGA	YZR	5	3000	210.0	185.0	35.0

YZR0005

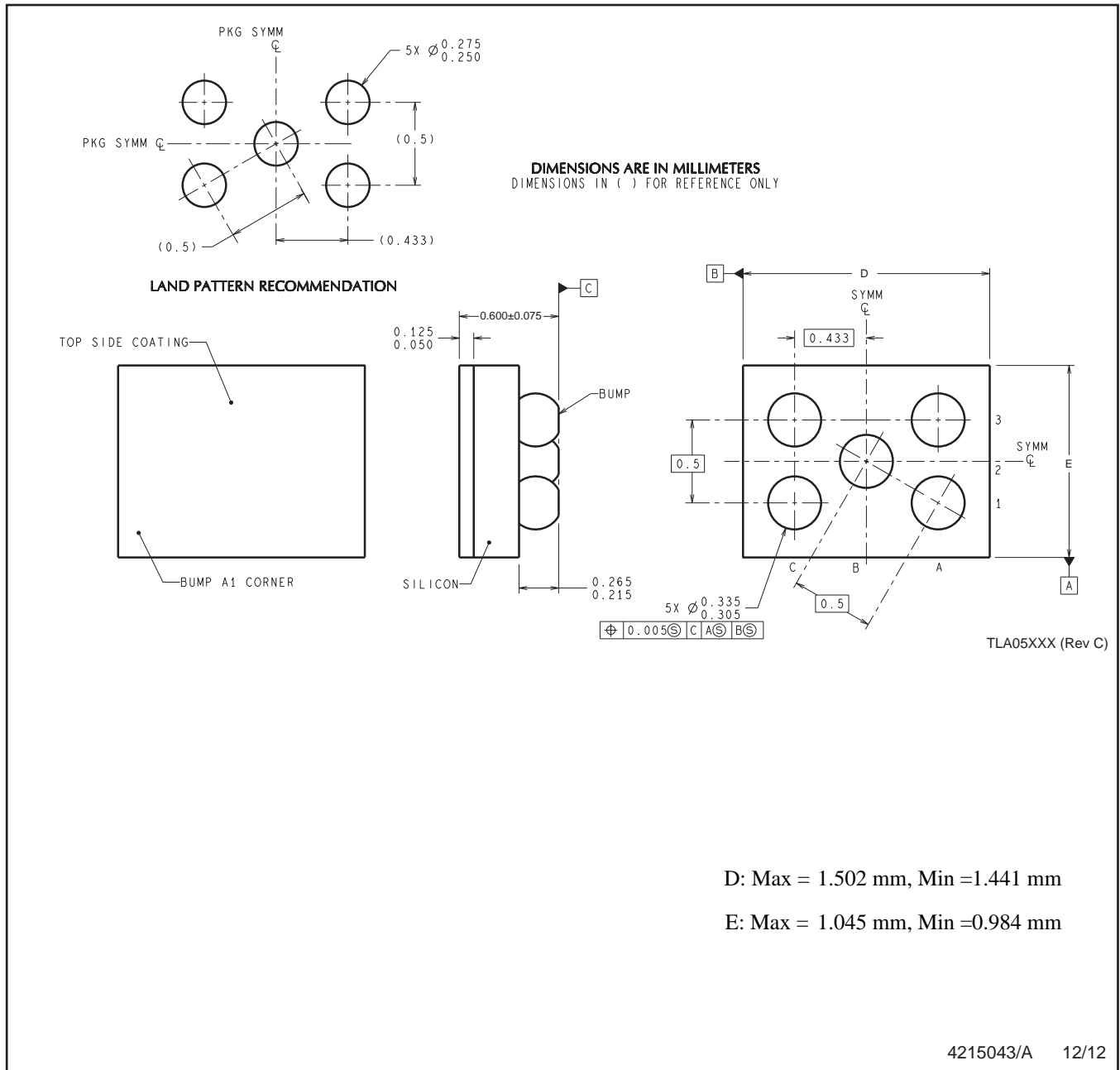

D: Max = 1.502 mm, Min = 1.441 mm

E: Max = 1.045 mm, Min = 0.984 mm

4215043/A 12/12

NOTES: A. All linear dimensions are in millimeters. Dimensioning and tolerancing per ASME Y14.5M-1994.
 B. This drawing is subject to change without notice.

IMPORTANT NOTICE

Texas Instruments Incorporated and its subsidiaries (TI) reserve the right to make corrections, enhancements, improvements and other changes to its semiconductor products and services per JESD46, latest issue, and to discontinue any product or service per JESD48, latest issue. Buyers should obtain the latest relevant information before placing orders and should verify that such information is current and complete. All semiconductor products (also referred to herein as "components") are sold subject to TI's terms and conditions of sale supplied at the time of order acknowledgment.

TI warrants performance of its components to the specifications applicable at the time of sale, in accordance with the warranty in TI's terms and conditions of sale of semiconductor products. Testing and other quality control techniques are used to the extent TI deems necessary to support this warranty. Except where mandated by applicable law, testing of all parameters of each component is not necessarily performed.

TI assumes no liability for applications assistance or the design of Buyers' products. Buyers are responsible for their products and applications using TI components. To minimize the risks associated with Buyers' products and applications, Buyers should provide adequate design and operating safeguards.

TI does not warrant or represent that any license, either express or implied, is granted under any patent right, copyright, mask work right, or other intellectual property right relating to any combination, machine, or process in which TI components or services are used. Information published by TI regarding third-party products or services does not constitute a license to use such products or services or a warranty or endorsement thereof. Use of such information may require a license from a third party under the patents or other intellectual property of the third party, or a license from TI under the patents or other intellectual property of TI.

Reproduction of significant portions of TI information in TI data books or data sheets is permissible only if reproduction is without alteration and is accompanied by all associated warranties, conditions, limitations, and notices. TI is not responsible or liable for such altered documentation. Information of third parties may be subject to additional restrictions.

Resale of TI components or services with statements different from or beyond the parameters stated by TI for that component or service voids all express and any implied warranties for the associated TI component or service and is an unfair and deceptive business practice. TI is not responsible or liable for any such statements.

Buyer acknowledges and agrees that it is solely responsible for compliance with all legal, regulatory and safety-related requirements concerning its products, and any use of TI components in its applications, notwithstanding any applications-related information or support that may be provided by TI. Buyer represents and agrees that it has all the necessary expertise to create and implement safeguards which anticipate dangerous consequences of failures, monitor failures and their consequences, lessen the likelihood of failures that might cause harm and take appropriate remedial actions. Buyer will fully indemnify TI and its representatives against any damages arising out of the use of any TI components in safety-critical applications.

In some cases, TI components may be promoted specifically to facilitate safety-related applications. With such components, TI's goal is to help enable customers to design and create their own end-product solutions that meet applicable functional safety standards and requirements. Nonetheless, such components are subject to these terms.

No TI components are authorized for use in FDA Class III (or similar life-critical medical equipment) unless authorized officers of the parties have executed a special agreement specifically governing such use.

Only those TI components which TI has specifically designated as military grade or "enhanced plastic" are designed and intended for use in military/aerospace applications or environments. Buyer acknowledges and agrees that any military or aerospace use of TI components which have **not** been so designated is solely at the Buyer's risk, and that Buyer is solely responsible for compliance with all legal and regulatory requirements in connection with such use.

TI has specifically designated certain components as meeting ISO/TS16949 requirements, mainly for automotive use. In any case of use of non-designated products, TI will not be responsible for any failure to meet ISO/TS16949.

Products

Audio	www.ti.com/audio
Amplifiers	amplifier.ti.com
Data Converters	dataconverter.ti.com
DLP® Products	www.dlp.com
DSP	dsp.ti.com
Clocks and Timers	www.ti.com/clocks
Interface	interface.ti.com
Logic	logic.ti.com
Power Mgmt	power.ti.com
Microcontrollers	microcontroller.ti.com
RFID	www.ti-rfid.com
OMAP Applications Processors	www.ti.com/omap
Wireless Connectivity	www.ti.com/wirelessconnectivity

Applications

Automotive and Transportation	www.ti.com/automotive
Communications and Telecom	www.ti.com/communications
Computers and Peripherals	www.ti.com/computers
Consumer Electronics	www.ti.com/consumer-apps
Energy and Lighting	www.ti.com/energy
Industrial	www.ti.com/industrial
Medical	www.ti.com/medical
Security	www.ti.com/security
Space, Avionics and Defense	www.ti.com/space-avionics-defense
Video and Imaging	www.ti.com/video

TI E2E Community

e2e.ti.com