

## LP3892 1.5A Fast-Response Ultra Low Dropout Linear Regulators

Check for Samples: [LP3892](#)

### FEATURES

- **Ultra Low Dropout Voltage (140 mV at 1.5A typ)**
- **Low Ground Pin Current**
- **Load Regulation of 0.04%/A**
- **60 nA Typical Quiescent Current in Shutdown**
- **1.5% Output Accuracy (25°C)**
- **TO-220, DDPAK/TO-263 and SO PowerPAD-8 Packages**
- **Over Temperature/Over Current Protection**
- **-40°C to +125°C Junction Temperature Range**

### APPLICATIONS

- **DSP Power Supplies**
- **Server Core and I/O Supplies**
- **PC Add-in-Cards**
- **Local Regulators in Set-Top Boxes**
- **Microcontroller Power Supplies**
- **High Efficiency Power Supplies**
- **SMPS Post-Regulators**

### DESCRIPTION

The LP3892 is a high current, fast response regulator which can maintain output voltage regulation with minimum input to output voltage drop. Fabricated on a CMOS process, the device operates from two input voltages: Vbias provides voltage to drive the gate of the N-MOS power transistor, while Vin is the input voltage which supplies power to the load. The use of an external bias rail allows the part to operate from ultra low Vin voltages. Unlike bipolar regulators, the CMOS architecture consumes extremely low quiescent current at any output load current. The use of an N-MOS power transistor results in wide bandwidth, yet minimum external capacitance is required to maintain loop stability.

The fast transient response of these devices makes them suitable for use in powering DSP, Microcontroller Core voltages and Switch Mode Power Supply post regulators. The parts are available in TO-220, DDPAK/TO-263 and SO PowerPAD-8 packages.

**Dropout Voltage:** 140mV (typ) at 1.5A load current.

**Ground Pin Current:** 3 mA (typ) at full load.

**Shutdown Current:** 60 nA (typ) when S/D pin is low.

**Precision Output Voltage:** 1.5% room temperature accuracy.

### TYPICAL APPLICATION CIRCUIT

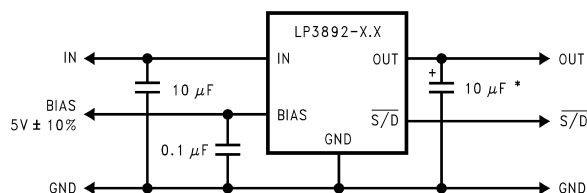

At least 10 µF of input and output capacitance is required for stability.

\*Tantalum capacitors are recommended. Aluminum electrolytic capacitors may be used for restricted temperature range. See application hints.



Please be aware that an important notice concerning availability, standard warranty, and use in critical applications of Texas Instruments semiconductor products and disclaimers thereto appears at the end of this data sheet.

All trademarks are the property of their respective owners.



These devices have limited built-in ESD protection. The leads should be shorted together or the device placed in conductive foam during storage or handling to prevent electrostatic damage to the MOS gates.

**CONNECTION DIAGRAM**

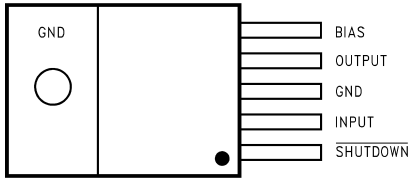

Figure 1. TO-220, Top View

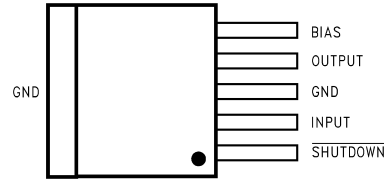

Figure 2. DDPAK/TO-263, Top View

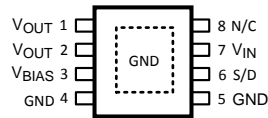
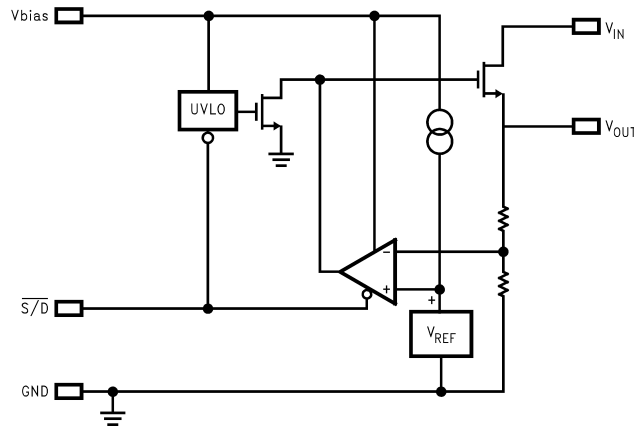

Figure 3. SO PowerPAD-8, Top View

**BLOCK DIAGRAM**



**ABSOLUTE MAXIMUM RATINGS** <sup>(1)</sup>

	VALUE / UNITS
Storage Temperature Range	–65°C to +150°C
Lead Temp. (Soldering, 5 seconds)	260°C
ESD Rating Human Body Model <sup>(2)</sup> Machine Model <sup>(3)</sup>	2 kV 200V
Power Dissipation <sup>(4)</sup>	Internally Limited
V <sub>IN</sub> Supply Voltage (Survival)	–0.3V to +6V
V <sub>BIAS</sub> Supply Voltage (Survival)	–0.3V to +7V
Shutdown Input Voltage (Survival)	–0.3V to +7V
I <sub>OUT</sub> (Survival)	Internally Limited
Output Voltage (Survival)	–0.3V to +6V
Junction Temperature	–40°C to +150°C

- (1) Absolute maximum ratings indicate limits beyond which damage to the component may occur. Operating ratings indicate conditions for which the device is intended to be functional, but do **not** ensure specific performance limits. For specifications, see Electrical Characteristics. Specifications do not apply when operating the device outside of its rated operating conditions.
- (2) The human body model is a 100 pF capacitor discharged through a 1.5k resistor into each pin.
- (3) The machine model is a 220 pF capacitor discharged directly into each pin. The machine model ESD rating of pin 5 is 100V.
- (4) At elevated temperatures, device power dissipation must be derated based on package thermal resistance and heatsink thermal values.  $\theta_{J-A}$  for TO-220 devices is 65°C/W if no heatsink is used. If the TO-220 device is attached to a heatsink, a  $\theta_{J-S}$  value of 4°C/W can be assumed.  $\theta_{J-A}$  for DDPAK/TO-263 devices is approximately 40°C/W if soldered down to a copper plane which is at least 1.5 square inches in area.  $\theta_{J-A}$  value for typical SO PowerPAD-8 PC board mounting is 166°C/W. If power dissipation causes the junction temperature to exceed specified limits, the device will go into thermal shutdown.

**RECOMMENDED OPERATING CONDITIONS**

	VALUE / UNITS
V <sub>IN</sub>	(V <sub>OUT</sub> + V <sub>DO</sub> ) to 5.5V
Shutdown	0 to +6V
I <sub>OUT</sub>	1.5A
Junction Temperature	–40°C to +125°C
V <sub>BIAS</sub>	4.5V to 6V

## ELECTRICAL CHARACTERISTICS

Limits in standard typeface are for  $T_J = 25^\circ\text{C}$ , and limits in **boldface type** apply over the full operating temperature range. Unless otherwise specified:  $V_{IN} = V_O(\text{NOM}) + 1\text{V}$ ,  $V_{BIAS} = 4.5\text{V}$ ,  $I_L = 10\text{ mA}$ ,  $C_{IN} = C_{OUT} = 10\mu\text{F}$ ,  $V_{S/D} = V_{BIAS}$ .

Symbol	Parameter	Conditions	MIN (1)	Typical (2)	MAX (1)	Units
$V_O$	Output Voltage Tolerance	$10\text{ mA} \leq I_L \leq 1.5\text{A}$ , $V_O(\text{NOM}) + 1\text{V} \leq V_{IN} \leq 5.5\text{V}$ , $4.5\text{V} \leq V_{BIAS} \leq 6\text{V}$	1.198 <b>1.186</b>	1.216	1.234 <b>1.246</b>	V
			1.478 <b>1.455</b>	1.5	1.522 <b>1.545</b>	
			1.773 <b>1.746</b>	1.8	1.827 <b>1.854</b>	
$\Delta V_O/\Delta V_{IN}$	Output Voltage Line Regulation <sup>(3) (4)</sup>	$V_O(\text{NOM}) + 1\text{V} \leq V_{IN} \leq 5.5\text{V}$		0.01		%/V
$\Delta V_O/\Delta I_L$	Output Voltage Load Regulation <sup>(5)</sup>	$10\text{ mA} \leq I_L \leq 1.5\text{A}$		0.04 <b>0.06</b>		%/A
$V_{DO}$	Dropout Voltage <sup>(6)</sup>	$I_L = 1.5\text{A}$ (TO-220 and DDPACK/TO-263 only)		140	320 <b>500</b>	mV
		$I_L = 1.5\text{A}$ (SO PowerPAD only)		155	340 <b>550</b>	
$I_Q(V_{IN})$	Quiescent Current Drawn from $V_{IN}$ Supply	$10\text{ mA} \leq I_L \leq 1.5\text{A}$		3	7 <b>8</b>	mA
		$\overline{V_{S/D}} \leq 0.3\text{V}$		0.03	1 <b>30</b>	
$I_Q(V_{BIAS})$	Quiescent Current Drawn from $V_{BIAS}$ Supply	$10\text{ mA} \leq I_L \leq 1.5\text{A}$		1	2 <b>3</b>	mA
		$\overline{V_{S/D}} \leq 0.3\text{V}$		0.03	1 <b>30</b>	
$I_{SC}$	Short-Circuit Current	$V_{OUT} = 0\text{V}$		4.3		A
<b>Shutdown Input</b>						
$V_{SDT}$	Output Turn-off Threshold	Output = ON	<b>1.3</b>	0.7		V
		Output = OFF		0.7	<b>0.3</b>	
$T_d(\text{OFF})$	Turn-OFF Delay	$R_{LOAD} \times C_{OUT} \ll T_d(\text{OFF})$		20		$\mu\text{s}$
$T_d(\text{ON})$	Turn-ON Delay	$R_{LOAD} \times C_{OUT} \ll T_d(\text{ON})$		15		
$\overline{I_{S/D}}$	$\overline{S/D}$ Input Current	$\overline{V_{S/D}} = 1.3\text{V}$		1		$\mu\text{A}$
		$\overline{V_{S/D}} \leq 0.3\text{V}$		-1		
<b>AC Parameters</b>						
PSRR ( $V_{IN}$ )	Ripple Rejection for $V_{IN}$ Input Voltage	$V_{IN} = V_{OUT} + 1\text{V}$ , $f = 120\text{ Hz}$		80		dB
		$V_{IN} = V_{OUT} + 1\text{V}$ , $f = 1\text{ kHz}$		65		
PSRR ( $V_{BIAS}$ )	Ripple Rejection for $V_{BIAS}$ Voltage	$V_{BIAS} = V_{OUT} + 3\text{V}$ , $f = 120\text{ Hz}$		70		
		$V_{BIAS} = V_{OUT} + 3\text{V}$ , $f = 1\text{ kHz}$		65		
	Output Noise Density	$f = 120\text{ Hz}$		1		$\mu\text{V}/\text{root-Hz}$
$e_n$	Output Noise Voltage	$\text{BW} = 10\text{ Hz} - 100\text{ kHz}$ , $V_{OUT} = 1.8\text{V}$		150		$\mu\text{V}$ (rms)
		$\text{BW} = 300\text{ Hz} - 300\text{ kHz}$ , $V_{OUT} = 1.8\text{V}$		90		

- (1) Limits are specified through testing, statistical correlation, or design.
- (2) Typical numbers represent the most likely parametric norm for  $25^\circ\text{C}$  operation.
- (3) If used in a dual-supply system where the regulator load is returned to a negative supply, the output pin must be diode clamped to ground.
- (4) Output voltage line regulation is defined as the change in output voltage from nominal value resulting from a change in input voltage.
- (5) Output voltage load regulation is defined as the change in output voltage from nominal value as the load current increases from no load to full load.
- (6) Dropout voltage is defined as the minimum input to output differential required to maintain the output with 2% of nominal value. The SO PowerPAD-8 package devices have a slightly higher dropout voltage due to increased band wire resistance.

**TYPICAL PERFORMANCE CHARACTERISTICS**

Unless otherwise specified:  $T_J = 25^\circ\text{C}$ ,  $C_{OUT} = 10\ \mu\text{F}$ ,  $C_{in} = 10\ \mu\text{F}$ ,  $\overline{S/D}$  pin is tied to  $V_{BIAS}$ ,  $V_{IN} = 2.2\text{V}$ ,  $V_{OUT} = 1.8\text{V}$ .

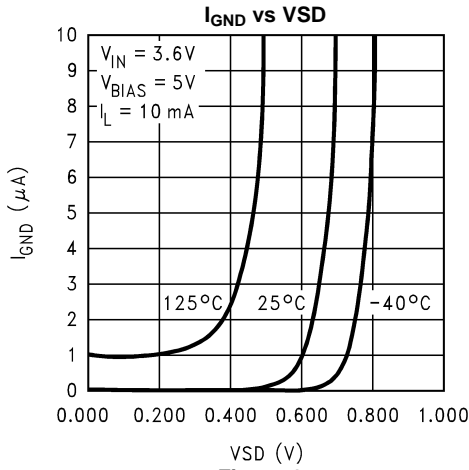

Figure 4.

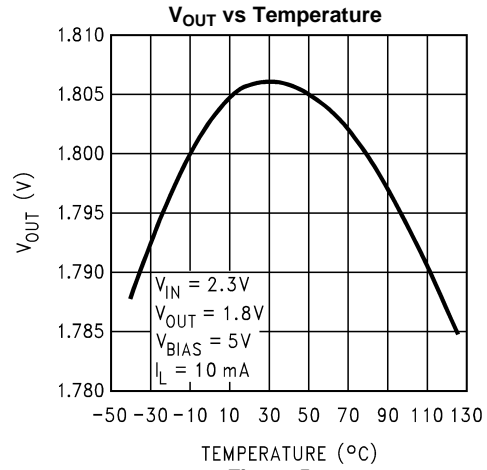

Figure 5.

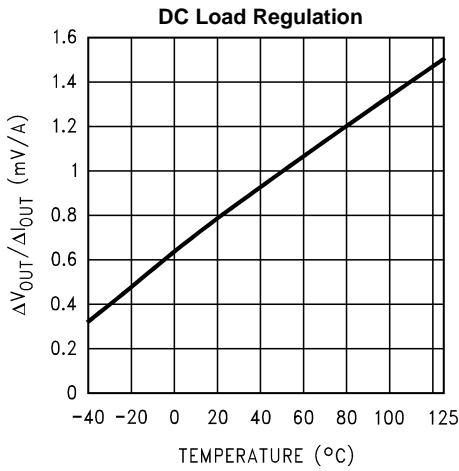

Figure 6.

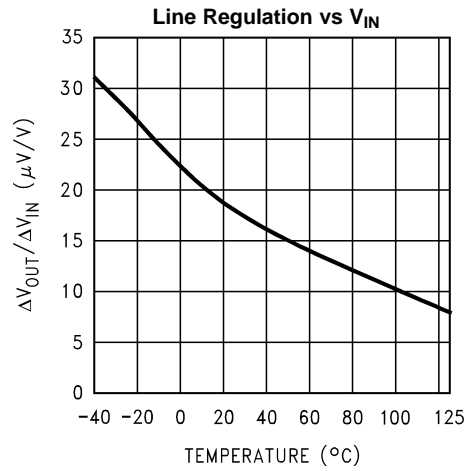

Figure 7.

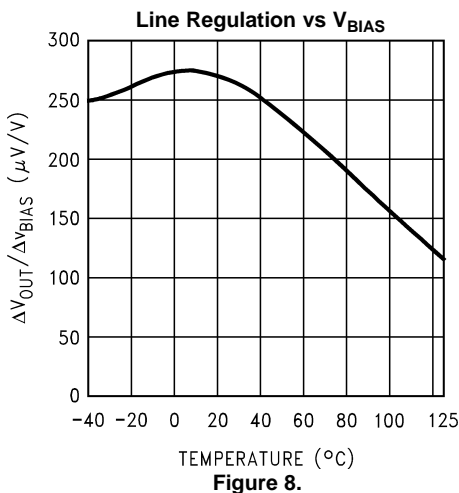

Figure 8.

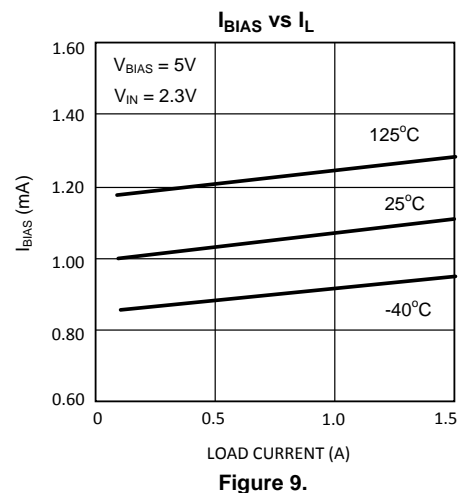

Figure 9.

**TYPICAL PERFORMANCE CHARACTERISTICS (continued)**

Unless otherwise specified:  $T_J = 25^\circ\text{C}$ ,  $C_{OUT} = 10 \mu\text{F}$ ,  $C_{in} = 10 \mu\text{F}$ ,  $\overline{S/D}$  pin is tied to  $V_{BIAS}$ ,  $V_{IN} = 2.2\text{V}$ ,  $V_{OUT} = 1.8\text{V}$ .

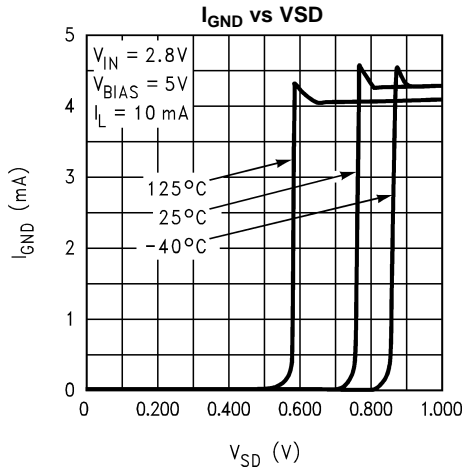

Figure 10.

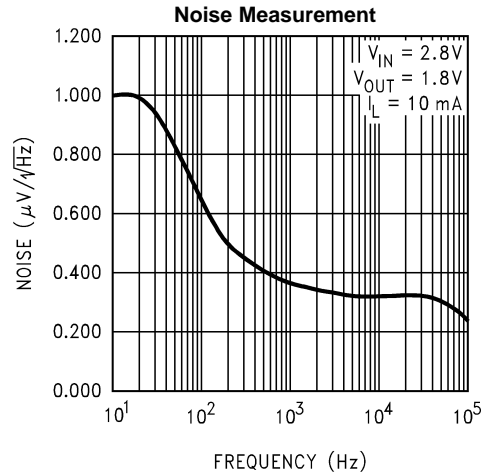

Figure 11.

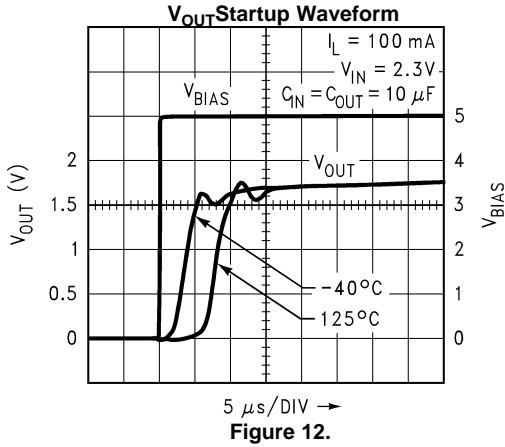

Figure 12.

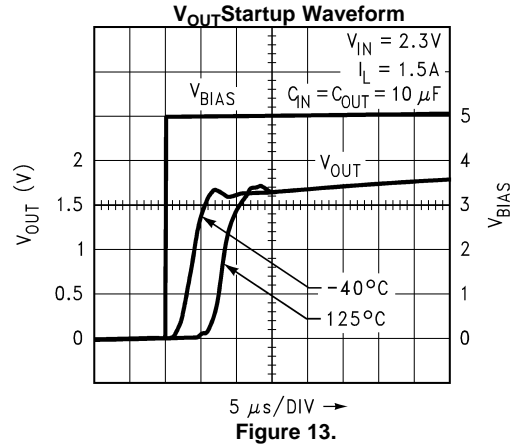

Figure 13.

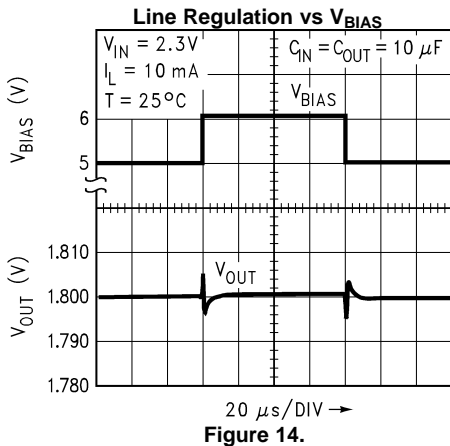

Figure 14.

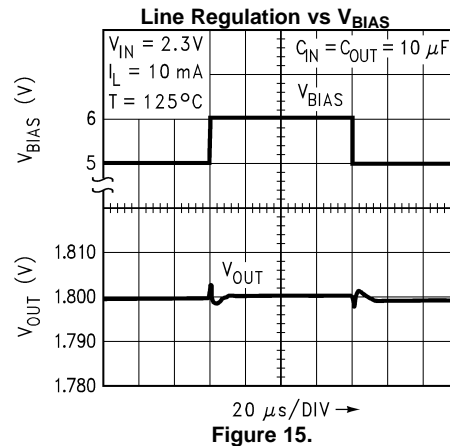

Figure 15.

**TYPICAL PERFORMANCE CHARACTERISTICS (continued)**

Unless otherwise specified:  $T_J = 25^\circ\text{C}$ ,  $C_{OUT} = 10 \mu\text{F}$ ,  $C_{in} = 10 \mu\text{F}$ ,  $\overline{S/D}$  pin is tied to  $V_{BIAS}$ ,  $V_{IN} = 2.2\text{V}$ ,  $V_{OUT} = 1.8\text{V}$ .

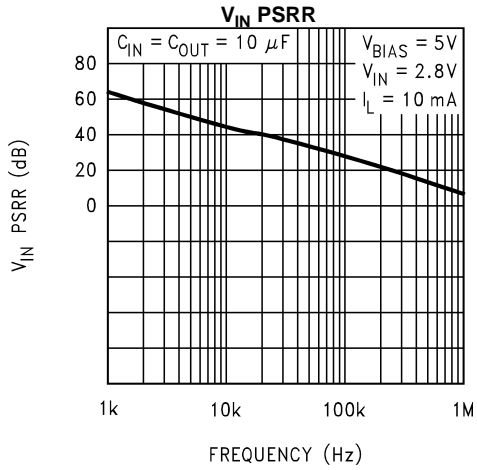

Figure 16.

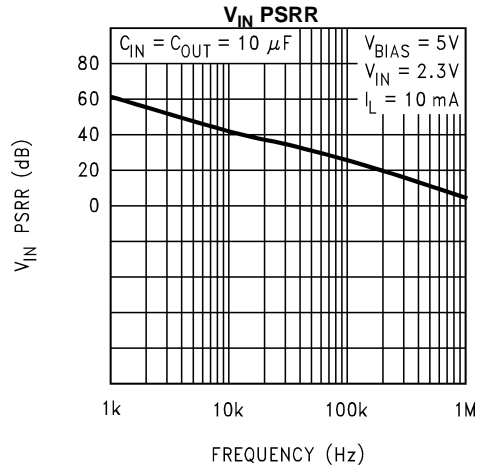

Figure 17.

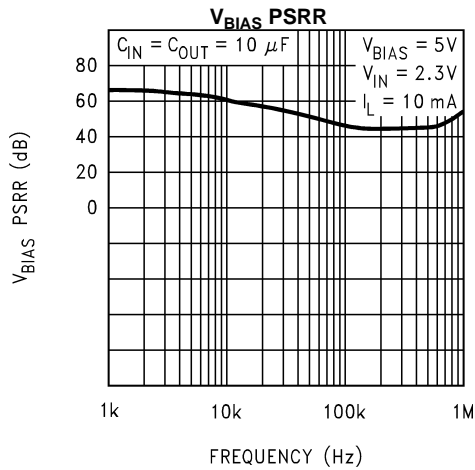

Figure 18.

## Application Hints

### EXTERNAL CAPACITORS

To assure regulator stability, input and output capacitors are required as shown in the Typical Application Circuit.

#### OUTPUT CAPACITOR

At least 10 $\mu$ F of output capacitance is required for stability (the amount of capacitance can be increased without limit). The output capacitor must be located less than 1 cm from the output pin of the IC and returned to a clean analog ground. The ESR (equivalent series resistance) of the output capacitor must be within the "stable" range as shown in Figure 19 over the full operating temperature range for stable operation.

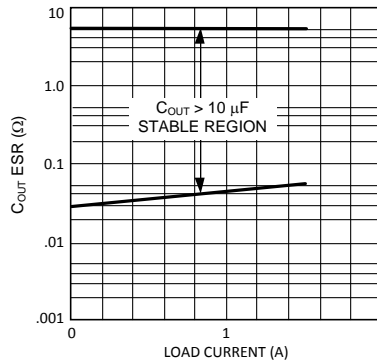

**Figure 19. Minimum ESR vs Output Load Current**

Tantalum capacitors are recommended for the output as their ESR is ideally suited to the part's requirements and the ESR is very stable over temperature. Aluminum electrolytics are not recommended because their ESR increases very rapidly at temperatures below 10°C. Aluminum caps can only be used in applications where lower temperature operation is not required.

A second problem with Al caps is that many have ESR's which are only specified at low frequencies. The typical loop bandwidth of a linear regulator is a few hundred kHz to several MHz. If an Al cap is used for the output cap, it must be one whose ESR is specified at a frequency of 100 kHz or more.

Because the ESR of ceramic capacitors is only a few milliohms, they are not suitable for use as output capacitors on LP389X devices. The regulator output can tolerate ceramic capacitance totaling up to 15% of the amount of Tantalum capacitance connected from the output to ground.

#### INPUT CAPACITOR

The input capacitor must be at least 10  $\mu$ F, but can be increased without limit. Its purpose is to provide a low source impedance for the regulator input. Ceramic capacitors work best for this, but Tantalums are also very good. There is no ESR limitation on the input capacitor (the lower, the better). Aluminum electrolytics can be used, but their ESR increase very quickly at cold temperatures. They are not recommended for any application where temperatures go below about 10°C.

#### BIAS CAPACITOR

The 0.1 $\mu$ F capacitor on the bias line can be any good quality capacitor (ceramic is recommended).

#### BIAS VOLTAGE

The bias voltage is an external voltage rail required to get gate drive for the N-FET pass transistor. Bias voltage must be in the range of 4.5 - 6V to assure proper operation of the part.

#### UNDER VOLTAGE LOCKOUT

The bias voltage is monitored by a circuit which prevents the regulator output from turning on if the bias voltage is below approximately 4V.



**SHUTDOWN OPERATION**

Pulling down the shutdown ( $\overline{S/D}$ ) pin will turn-off the regulator. Pin  $\overline{S/D}$  must be actively terminated through a pull-up resistor (10 kΩ to 100 kΩ) for a proper operation. If this pin is driven from a source that actively pulls high and low (such as a CMOS rail to rail comparator), the pull-up resistor is not required. This pin must be tied to Vin if not used.

**POWER DISSIPATION/HEATSINKING**

A heatsink may be required depending on the maximum power dissipation and maximum ambient temperature of the application. Under all possible conditions, the junction temperature must be within the range specified under operating conditions. The total power dissipation of the device is given by:

$$P_D = (V_{IN} - V_{OUT})I_{OUT} + (V_{IN})I_{GND} \tag{1}$$

where  $I_{GND}$  is the operating ground current of the device.

The maximum allowable temperature rise ( $T_{Rmax}$ ) depends on the maximum ambient temperature ( $T_{Amax}$ ) of the application, and the maximum allowable junction temperature ( $T_{Jmax}$ ):

$$T_{Rmax} = T_{Jmax} - T_{Amax} \tag{2}$$

The maximum allowable value for junction to ambient Thermal Resistance,  $\theta_{JA}$ , can be calculated using the formula:

$$\theta_{JA} = T_{Rmax} / P_D \tag{3}$$

These parts are available in TO-220 and DDPAK/TO-263 packages. The thermal resistance depends on amount of copper area or heat sink, and on air flow. If the maximum allowable value of  $\theta_{JA}$  calculated above is  $\geq 60$  °C/W for TO-220 package and  $\geq 60$  °C/W for DDPAK/TO-263 package no heatsink is needed since the package can dissipate enough heat to satisfy these requirements. If the value for allowable  $\theta_{JA}$  falls below these limits, a heat sink is required.

**HEATSINKING TO-220 PACKAGE**

The thermal resistance of a TO-220 package can be reduced by attaching it to a heat sink or a copper plane on a PC board. If a copper plane is to be used, the values of  $\theta_{JA}$  will be same as shown in next section for DDPAK/TO-263 package.

The heatsink to be used in the application should have a heatsink to ambient thermal resistance,  $\theta_{HA} \leq \theta_{JA} - \theta_{CH} - \theta_{JC}$ .

In this equation,  $\theta_{CH}$  is the thermal resistance from the case to the surface of the heat sink and  $\theta_{JC}$  is the thermal resistance from the junction to the surface of the case.  $\theta_{JC}$  is about 3°C/W for a TO-220 package. The value for  $\theta_{CH}$  depends on method of attachment, insulator, etc.  $\theta_{CH}$  varies between 1.5°C/W to 2.5°C/W. If the exact value is unknown, 2°C/W can be assumed.

**HEATSINKING DDPAK/TO-263 PACKAGE**

The DDPAK/TO-263 package uses the copper plane on the PCB as a heatsink. The tab of these packages are soldered to the copper plane for heat sinking. The graph below shows a curve for the  $\theta_{JA}$  of DDPAK/TO-263 package for different copper area sizes, using a typical PCB with 1 ounce copper and no solder mask over the copper area for heat sinking.

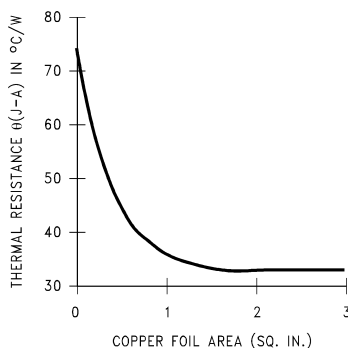

**Figure 20.  $\theta_{JA}$  vs Copper (1 Ounce) Area for DDPAK/TO-263 Package**

As shown in the graph below, increasing the copper area beyond 1 square inch produces very little improvement. The minimum value for  $\theta_{JA}$  for the DDPAK/TO-263 package mounted to a PCB is 32°C/W.

Figure 22 shows the maximum allowable power dissipation for DDPAK/TO-263 packages for different ambient temperatures, assuming  $\theta_{JA}$  is 35°C/W and the maximum junction temperature is 125°C.

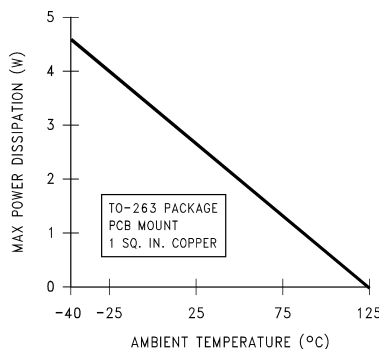
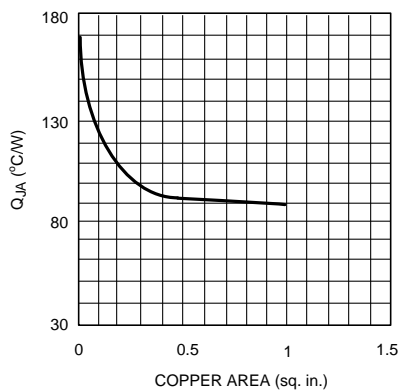

**Figure 21. Maximum Power Dissipation vs Ambient Temperature for DDPAK/TO-263 Package**

### HEATSINKING SO PowerPAD PACKAGE

Heatsinking for the SO PowerPAD-8 package is accomplished by allowing heat to flow through the ground slug on the bottom of the package into the copper on the PC board. The heat slug must be soldered down to a copper plane to get good heat transfer. It can also be connected through vias to internal copper planes. Since the heat slug is at ground potential, traces must not be routed under it which are not at ground potential. Under all possible conditions, the junction temperature must be within the range specified under operating conditions.

Figure 22 shows a curve for the  $\theta_{JA}$  of the SO PowerPAD package for different copper area sizes using a typical PCB with one ounce copper in still air.



**Figure 22.  $\theta_{JA}$  vs Copper (1 ounce) Area for SO PowerPAD Package**

---

**REVISION HISTORY**

<b>Changes from Revision C (April 2013) to Revision D</b>	<b>Page</b>
<hr/> <ul style="list-style-type: none"><li>• Changed layout of National Data Sheet to TI format .....</li></ul>	<hr/> <a href="#">10</a>

**PACKAGING INFORMATION**

Orderable Device	Status (1)	Package Type	Package Drawing	Pins	Package Qty	Eco Plan (2)	Lead/Ball Finish	MSL Peak Temp (3)	Op Temp (°C)	Top-Side Markings (4)	Samples
LP3892EMR-1.2	ACTIVE	SO PowerPAD	DDA	8	95	TBD	Call TI	Call TI	-40 to 125	3892E MR1.2	<a href="#">Samples</a>
LP3892EMR-1.2/NOPB	ACTIVE	SO PowerPAD	DDA	8	95	Green (RoHS & no Sb/Br)	CU SN	Level-3-260C-168 HR	-40 to 125	3892E MR1.2	<a href="#">Samples</a>
LP3892EMR-1.5	ACTIVE	SO PowerPAD	DDA	8	95	TBD	Call TI	Call TI	-40 to 125	3892E MR1.5	<a href="#">Samples</a>
LP3892EMR-1.5/NOPB	ACTIVE	SO PowerPAD	DDA	8	95	Green (RoHS & no Sb/Br)	CU SN	Level-3-260C-168 HR	-40 to 125	3892E MR1.5	<a href="#">Samples</a>
LP3892EMR-1.8	ACTIVE	SO PowerPAD	DDA	8	95	TBD	Call TI	Call TI	-40 to 125	3892E MR1.8	<a href="#">Samples</a>
LP3892EMR-1.8/NOPB	ACTIVE	SO PowerPAD	DDA	8	95	Green (RoHS & no Sb/Br)	CU SN	Level-3-260C-168 HR	-40 to 125	3892E MR1.8	<a href="#">Samples</a>
LP3892EMRX-1.2	ACTIVE	SO PowerPAD	DDA	8	2500	TBD	Call TI	Call TI	-40 to 125	3892E MR1.2	<a href="#">Samples</a>
LP3892EMRX-1.2/NOPB	ACTIVE	SO PowerPAD	DDA	8	2500	Green (RoHS & no Sb/Br)	CU SN	Level-3-260C-168 HR	-40 to 125	3892E MR1.2	<a href="#">Samples</a>
LP3892EMRX-1.5	ACTIVE	SO PowerPAD	DDA	8	2500	TBD	Call TI	Call TI	-40 to 125	3892E MR1.5	<a href="#">Samples</a>
LP3892EMRX-1.5/NOPB	ACTIVE	SO PowerPAD	DDA	8	2500	Green (RoHS & no Sb/Br)	CU SN	Level-3-260C-168 HR	-40 to 125	3892E MR1.5	<a href="#">Samples</a>
LP3892ES-1.2	ACTIVE	DDPAK/ TO-263	KTT	5	45	TBD	Call TI	Call TI	-40 to 125	LP3892ES -1.2	<a href="#">Samples</a>
LP3892ES-1.2/NOPB	ACTIVE	DDPAK/ TO-263	KTT	5	45	Pb-Free (RoHS Exempt)	CU SN	Level-3-245C-168 HR	-40 to 125	LP3892ES -1.2	<a href="#">Samples</a>
LP3892ES-1.5	ACTIVE	DDPAK/ TO-263	KTT	5	45	TBD	Call TI	Call TI	-40 to 125	LP3892ES -1.5	<a href="#">Samples</a>
LP3892ES-1.5/NOPB	ACTIVE	DDPAK/ TO-263	KTT	5	45	Pb-Free (RoHS Exempt)	CU SN	Level-3-245C-168 HR	-40 to 125	LP3892ES -1.5	<a href="#">Samples</a>
LP3892ESX-1.2	ACTIVE	DDPAK/ TO-263	KTT	5	500	TBD	Call TI	Call TI	-40 to 125	LP3892ES -1.2	<a href="#">Samples</a>
LP3892ESX-1.2/NOPB	ACTIVE	DDPAK/ TO-263	KTT	5	500	Pb-Free (RoHS Exempt)	CU SN	Level-3-245C-168 HR	-40 to 125	LP3892ES -1.2	<a href="#">Samples</a>
LP3892ESX-1.5	ACTIVE	DDPAK/ TO-263	KTT	5	500	TBD	Call TI	Call TI	-40 to 125	LP3892ES -1.5	<a href="#">Samples</a>

Orderable Device	Status (1)	Package Type	Package Drawing	Pins	Package Qty	Eco Plan (2)	Lead/Ball Finish	MSL Peak Temp (3)	Op Temp (°C)	Top-Side Markings (4)	Samples
LP3892ESX-1.5/NOPB	ACTIVE	DDPAK/ TO-263	KTT	5	500	Pb-Free (RoHS Exempt)	CU SN	Level-3-245C-168 HR	-40 to 125	LP3892ES -1.5	

(1) The marketing status values are defined as follows:

**ACTIVE:** Product device recommended for new designs.

**LIFEBUY:** TI has announced that the device will be discontinued, and a lifetime-buy period is in effect.

**NRND:** Not recommended for new designs. Device is in production to support existing customers, but TI does not recommend using this part in a new design.

**PREVIEW:** Device has been announced but is not in production. Samples may or may not be available.

**OBSELETE:** TI has discontinued the production of the device.

(2) Eco Plan - The planned eco-friendly classification: Pb-Free (RoHS), Pb-Free (RoHS Exempt), or Green (RoHS & no Sb/Br) - please check <http://www.ti.com/productcontent> for the latest availability information and additional product content details.

**TBD:** The Pb-Free/Green conversion plan has not been defined.

**Pb-Free (RoHS):** TI's terms "Lead-Free" or "Pb-Free" mean semiconductor products that are compatible with the current RoHS requirements for all 6 substances, including the requirement that lead not exceed 0.1% by weight in homogeneous materials. Where designed to be soldered at high temperatures, TI Pb-Free products are suitable for use in specified lead-free processes.

**Pb-Free (RoHS Exempt):** This component has a RoHS exemption for either 1) lead-based flip-chip solder bumps used between the die and package, or 2) lead-based die adhesive used between the die and leadframe. The component is otherwise considered Pb-Free (RoHS compatible) as defined above.

**Green (RoHS & no Sb/Br):** TI defines "Green" to mean Pb-Free (RoHS compatible), and free of Bromine (Br) and Antimony (Sb) based flame retardants (Br or Sb do not exceed 0.1% by weight in homogeneous material)

(3) MSL, Peak Temp. -- The Moisture Sensitivity Level rating according to the JEDEC industry standard classifications, and peak solder temperature.

(4) Multiple Top-Side Markings will be inside parentheses. Only one Top-Side Marking contained in parentheses and separated by a "~" will appear on a device. If a line is indented then it is a continuation of the previous line and the two combined represent the entire Top-Side Marking for that device.

**Important Information and Disclaimer:** The information provided on this page represents TI's knowledge and belief as of the date that it is provided. TI bases its knowledge and belief on information provided by third parties, and makes no representation or warranty as to the accuracy of such information. Efforts are underway to better integrate information from third parties. TI has taken and continues to take reasonable steps to provide representative and accurate information but may not have conducted destructive testing or chemical analysis on incoming materials and chemicals. TI and TI suppliers consider certain information to be proprietary, and thus CAS numbers and other limited information may not be available for release.

In no event shall TI's liability arising out of such information exceed the total purchase price of the TI part(s) at issue in this document sold by TI to Customer on an annual basis.

## TAPE AND REEL INFORMATION



### QUADRANT ASSIGNMENTS FOR PIN 1 ORIENTATION IN TAPE



\*All dimensions are nominal

Device	Package Type	Package Drawing	Pins	SPQ	Reel Diameter (mm)	Reel Width W1 (mm)	A0 (mm)	B0 (mm)	K0 (mm)	P1 (mm)	W (mm)	Pin1 Quadrant
LP3892EMRX-1.2	SO Power PAD	DDA	8	2500	330.0	12.4	6.5	5.4	2.0	8.0	12.0	Q1
LP3892EMRX-1.2/NOPB	SO Power PAD	DDA	8	2500	330.0	12.4	6.5	5.4	2.0	8.0	12.0	Q1
LP3892EMRX-1.5	SO Power PAD	DDA	8	2500	330.0	12.4	6.5	5.4	2.0	8.0	12.0	Q1
LP3892EMRX-1.5/NOPB	SO Power PAD	DDA	8	2500	330.0	12.4	6.5	5.4	2.0	8.0	12.0	Q1
LP3892ESX-1.2	DDPAK/TO-263	KTT	5	500	330.0	24.4	10.75	14.85	5.0	16.0	24.0	Q2
LP3892ESX-1.2/NOPB	DDPAK/TO-263	KTT	5	500	330.0	24.4	10.75	14.85	5.0	16.0	24.0	Q2
LP3892ESX-1.5	DDPAK/TO-263	KTT	5	500	330.0	24.4	10.75	14.85	5.0	16.0	24.0	Q2
LP3892ESX-1.5/NOPB	DDPAK/TO-263	KTT	5	500	330.0	24.4	10.75	14.85	5.0	16.0	24.0	Q2

**TAPE AND REEL BOX DIMENSIONS**



\*All dimensions are nominal

Device	Package Type	Package Drawing	Pins	SPQ	Length (mm)	Width (mm)	Height (mm)
LP3892EMRX-1.2	SO PowerPAD	DDA	8	2500	367.0	367.0	35.0
LP3892EMRX-1.2/NOPB	SO PowerPAD	DDA	8	2500	367.0	367.0	35.0
LP3892EMRX-1.5	SO PowerPAD	DDA	8	2500	367.0	367.0	35.0
LP3892EMRX-1.5/NOPB	SO PowerPAD	DDA	8	2500	367.0	367.0	35.0
LP3892ESX-1.2	DDPAK/TO-263	KTT	5	500	367.0	367.0	45.0
LP3892ESX-1.2/NOPB	DDPAK/TO-263	KTT	5	500	367.0	367.0	45.0
LP3892ESX-1.5	DDPAK/TO-263	KTT	5	500	367.0	367.0	45.0
LP3892ESX-1.5/NOPB	DDPAK/TO-263	KTT	5	500	367.0	367.0	45.0

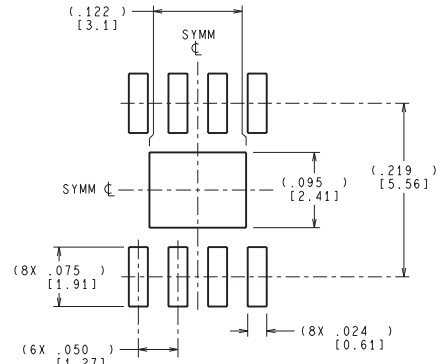
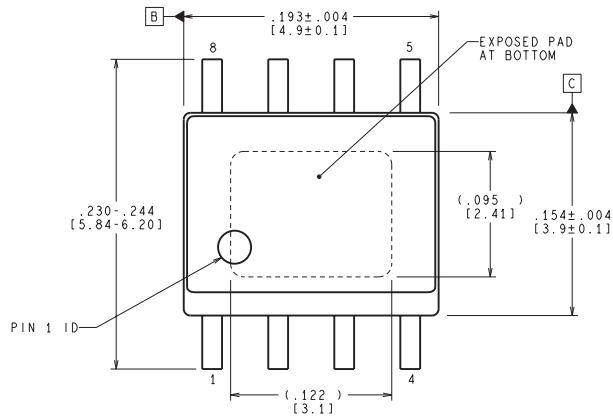
DDA0008B

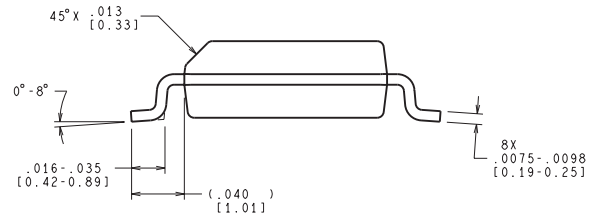
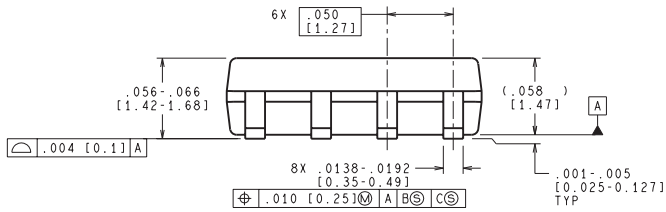

RECOMMENDED LAND PATTERN



CONTROLLING DIMENSION IS INCH  
VALUES IN [ ] ARE MILLIMETERS  
DIMENSIONS IN ( ) FOR REFERENCE ONLY

MRA08B (Rev B)



KTT0005B



CONTROLLING DIMENSION IS INCH  
 VALUES IN [ ] ARE MILLIMETERS  
 DIMENSIONS IN ( ) FOR REFERENCE ONLY

TS5B (Rev D)

## IMPORTANT NOTICE

Texas Instruments Incorporated and its subsidiaries (TI) reserve the right to make corrections, enhancements, improvements and other changes to its semiconductor products and services per JESD46, latest issue, and to discontinue any product or service per JESD48, latest issue. Buyers should obtain the latest relevant information before placing orders and should verify that such information is current and complete. All semiconductor products (also referred to herein as "components") are sold subject to TI's terms and conditions of sale supplied at the time of order acknowledgment.

TI warrants performance of its components to the specifications applicable at the time of sale, in accordance with the warranty in TI's terms and conditions of sale of semiconductor products. Testing and other quality control techniques are used to the extent TI deems necessary to support this warranty. Except where mandated by applicable law, testing of all parameters of each component is not necessarily performed.

TI assumes no liability for applications assistance or the design of Buyers' products. Buyers are responsible for their products and applications using TI components. To minimize the risks associated with Buyers' products and applications, Buyers should provide adequate design and operating safeguards.

TI does not warrant or represent that any license, either express or implied, is granted under any patent right, copyright, mask work right, or other intellectual property right relating to any combination, machine, or process in which TI components or services are used. Information published by TI regarding third-party products or services does not constitute a license to use such products or services or a warranty or endorsement thereof. Use of such information may require a license from a third party under the patents or other intellectual property of the third party, or a license from TI under the patents or other intellectual property of TI.

Reproduction of significant portions of TI information in TI data books or data sheets is permissible only if reproduction is without alteration and is accompanied by all associated warranties, conditions, limitations, and notices. TI is not responsible or liable for such altered documentation. Information of third parties may be subject to additional restrictions.

Resale of TI components or services with statements different from or beyond the parameters stated by TI for that component or service voids all express and any implied warranties for the associated TI component or service and is an unfair and deceptive business practice. TI is not responsible or liable for any such statements.

Buyer acknowledges and agrees that it is solely responsible for compliance with all legal, regulatory and safety-related requirements concerning its products, and any use of TI components in its applications, notwithstanding any applications-related information or support that may be provided by TI. Buyer represents and agrees that it has all the necessary expertise to create and implement safeguards which anticipate dangerous consequences of failures, monitor failures and their consequences, lessen the likelihood of failures that might cause harm and take appropriate remedial actions. Buyer will fully indemnify TI and its representatives against any damages arising out of the use of any TI components in safety-critical applications.

In some cases, TI components may be promoted specifically to facilitate safety-related applications. With such components, TI's goal is to help enable customers to design and create their own end-product solutions that meet applicable functional safety standards and requirements. Nonetheless, such components are subject to these terms.

No TI components are authorized for use in FDA Class III (or similar life-critical medical equipment) unless authorized officers of the parties have executed a special agreement specifically governing such use.

Only those TI components which TI has specifically designated as military grade or "enhanced plastic" are designed and intended for use in military/aerospace applications or environments. Buyer acknowledges and agrees that any military or aerospace use of TI components which have **not** been so designated is solely at the Buyer's risk, and that Buyer is solely responsible for compliance with all legal and regulatory requirements in connection with such use.

TI has specifically designated certain components as meeting ISO/TS16949 requirements, mainly for automotive use. In any case of use of non-designated products, TI will not be responsible for any failure to meet ISO/TS16949.

### Products

Audio	<a href="http://www.ti.com/audio">www.ti.com/audio</a>
Amplifiers	<a href="http://amplifier.ti.com">amplifier.ti.com</a>
Data Converters	<a href="http://dataconverter.ti.com">dataconverter.ti.com</a>
DLP® Products	<a href="http://www.dlp.com">www.dlp.com</a>
DSP	<a href="http://dsp.ti.com">dsp.ti.com</a>
Clocks and Timers	<a href="http://www.ti.com/clocks">www.ti.com/clocks</a>
Interface	<a href="http://interface.ti.com">interface.ti.com</a>
Logic	<a href="http://logic.ti.com">logic.ti.com</a>
Power Mgmt	<a href="http://power.ti.com">power.ti.com</a>
Microcontrollers	<a href="http://microcontroller.ti.com">microcontroller.ti.com</a>
RFID	<a href="http://www.ti-rfid.com">www.ti-rfid.com</a>
OMAP Applications Processors	<a href="http://www.ti.com/omap">www.ti.com/omap</a>
Wireless Connectivity	<a href="http://www.ti.com/wirelessconnectivity">www.ti.com/wirelessconnectivity</a>

### Applications

Automotive and Transportation	<a href="http://www.ti.com/automotive">www.ti.com/automotive</a>
Communications and Telecom	<a href="http://www.ti.com/communications">www.ti.com/communications</a>
Computers and Peripherals	<a href="http://www.ti.com/computers">www.ti.com/computers</a>
Consumer Electronics	<a href="http://www.ti.com/consumer-apps">www.ti.com/consumer-apps</a>
Energy and Lighting	<a href="http://www.ti.com/energy">www.ti.com/energy</a>
Industrial	<a href="http://www.ti.com/industrial">www.ti.com/industrial</a>
Medical	<a href="http://www.ti.com/medical">www.ti.com/medical</a>
Security	<a href="http://www.ti.com/security">www.ti.com/security</a>
Space, Avionics and Defense	<a href="http://www.ti.com/space-avionics-defense">www.ti.com/space-avionics-defense</a>
Video and Imaging	<a href="http://www.ti.com/video">www.ti.com/video</a>

### TI E2E Community

[e2e.ti.com](http://e2e.ti.com)