

LM3557 Step-Up Converter for White LED Applications

Check for Samples: [LM3557](#)

FEATURES

- V_{IN} Range: 2.7V–7.5V
- Small External Components
- 1.25 MHz Constant-Switching Frequency
- Output Over-Voltage Protection
- Input Under-Voltage Protection
- Cycle-By-Cycle Current Limit
- TRUE SHUTDOWN: No DC current paths to ground during shutdown
- Low Profile Package: <1 mm Height -8 Pin WSON
- No External Compensation

APPLICATIONS

- White LED Display Lighting
- Cellular Phones
- PDAs

Typical Application Circuit

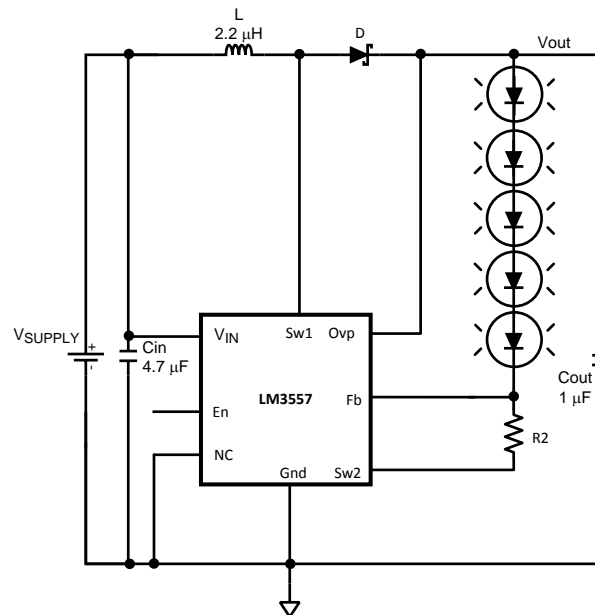

Figure 1. Backlight Configuration

DESCRIPTION

The LM3557 is a complete solution for white LED drive applications. With minimal external component count, no DC current leakage paths to ground, cycle-by-cycle current limit protection, and output over-voltage protection circuitry, the LM3557 offer superior performance and cost savings over standard DC/DC boost component implementations.

The LM3557 switches at a fixed-frequency of 1.25 MHz, which allows for the use of small external components. Also, the LM3557 has a wide input voltage range to take advantage of multi-cell input applications. With small external components, high fixed frequency operation, and wide input voltage range, the LM3557 is the most optimal choice for LED lighting applications.



Please be aware that an important notice concerning availability, standard warranty, and use in critical applications of Texas Instruments semiconductor products and disclaimers thereto appears at the end of this data sheet.

All trademarks are the property of their respective owners.

Connection Diagram

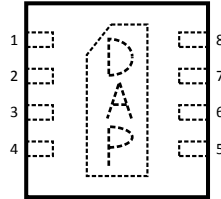

**Figure 2. 8-Lead Thin WSON Package
(Top View)**

PIN DESCRIPTIONS

Name	Pin No.	Description
Sw1	1	Drain Connection of the Internal Power Field Effect Transistor (FET) Switch (Figure 3: N1)
V _{IN}	2	Input Voltage Connection
NC	3	No Connection
En	4	Device Enable Connection
Ovp	5	Over-Voltage Protection Input Connection
Fb	6	Feedback Voltage Connection
Sw2	7	Drain Connection of an Internal Field Effect Transistor (FET) Switch (Figure 3: N2)
Gnd	8	Ground Connection
DAP	DAP	Die Attach Pad (DAP), must be soldered to the printed circuit board's ground plane for enhanced thermal dissipation



These devices have limited built-in ESD protection. The leads should be shorted together or the device placed in conductive foam during storage or handling to prevent electrostatic damage to the MOS gates.

Absolute Maximum Ratings ⁽¹⁾⁽²⁾

V _{IN} Pin	-0.3V to +8V
En Pin	-0.3V to +8V
Fb Pin	-0.3V to +8V
Sw2 Pin	-0.3V to +8V
Ovp Pin	-0.3V to +30V
Sw1 Pin	-0.3V to +40V
Continuous Power Dissipation	Internally Limited
Maximum Junction Temperature (T _{J-MAX})	+150°C
Storage Temperature Range	-65°C to +150°C
ESD Rating ⁽³⁾	
Human Body Model	2 kV
Machine Model	150V

- (1) Absolute maximum ratings indicate limits beyond which damage to the device may occur. Electrical characteristic specifications do not apply when operating the device outside of its rated operating conditions.
- (2) **If Military/Aerospace specified devices are required, please contact the Texas Instruments Sales Office / Distributors for availability and specifications.**
- (3) The human body model is a 100 pF capacitor discharged through a 1.5 kΩ resistor into each pin. The machine model is a 200 pF capacitor discharged directly into each pin.

Operating Conditions ⁽¹⁾ ⁽²⁾

Junction Temperature (T _J) Range	-40°C to +125°C
Ambient Temperature (T _A) Range	-40°C to +85°C
Supply Voltage, V _{IN} Pin	2.7V to 7.5V
En Pin	0V to V _{IN} +0.4V

- (1) Absolute maximum ratings indicate limits beyond which damage to the device may occur. Electrical characteristic specifications do not apply when operating the device outside of its rated operating conditions.
- (2) All voltages are with respect to the potential at the GND pin.

THERMAL CHARACTERISTICS ⁽¹⁾ ⁽²⁾

over operating free-air temperature range (unless otherwise noted)

Junction-to-Ambient Thermal Resistance (θ _{JA}), WSON Package	55°C/W
---	--------

- (1) The maximum allowable power dissipation is a function of the maximum junction temperature, T_J(MAX), the junction-to-ambient thermal resistance, θ_{JA}, and the ambient temperature, T_A. See Thermal Properties for the thermal resistance. The maximum allowable power dissipation at any ambient temperature is calculated using: P_D(MAX) = (T_J(MAX) – T_A)/θ_{JA}. Exceeding the maximum allowable power dissipation will cause excessive die temperature.
- (2) Junction-to-ambient thermal resistance (θ_{JA}) is taken from a thermal modeling result, performed under the conditions and guidelines set forth in the JEDEC standard JESD51-7. The test board is a 4 layer FR-4 board measuring 102 mm x 76 mm x 1.6 mm with a 2 x 1 array of thermal vias. The ground plane on the board is 50 mm x 50 mm. Thickness of copper layers are 36 μm/18 μm/18 μm/36 μm (1.5 oz/1 oz/1 oz/1.5 oz). Ambient temperature in simulation is 22°C, still air. Power dissipation is 1W. In applications where high maximum power dissipation exists, special care must be paid to thermal dissipation issues. For more information on these topics, please refer to **Application Note 1187: Leadless Leadframe Package (LLP)** and the **Layout Guidelines** section of this datasheet.

Electrical Characteristics ⁽¹⁾ ⁽²⁾

Limits in standard typeface are for T_J = 25°C. Limits in **bold typeface** apply over the full operating junction temperature range (-40°C ≤ T_J ≤ +125°C). Unless otherwise specified: V_{IN} = 3.6V.

Parameter		Test Conditions	Min	Typ	Max	Units
V _{IN}	Input Voltage		2.7		7.5	V
I _Q	Quiescent Current	V _{EN} = 0V (Shutdown) V _{EN} = 1.8V; V _{OVP} = 27V (Non-Switching)		0.01 0.55	2 0.8	μA mA
En	Device Enable Threshold	Device On Device Off	0.9		0.3	V
I _{CL}	Power Switch Current Limit ⁽³⁾	V _{IN} = 3V	0.4 0.55	0.8 0.8	1.1 1.02	A
R _{DS(ON)}	Power Switch ON Resistance	I _{SW1} = 175 mA		800	1000	mΩ
TC (R _{DS(ON)})	R _{DS(ON)} Temperature Coefficient			0.5		%/C
OVP	Over-Voltage Protection ⁽⁴⁾	On Threshold Off Threshold	22 21.5	26 25.5	28.5 28	V
UVP	Under-Voltage Protection ⁽⁴⁾	On Threshold Off Threshold		2.2 2.3		V
I _{OVP}	Over-Voltage Protection Pin Bias Current ⁽⁵⁾			4	10	μA
I _{EN}	Enable Pin Bias Current ⁽⁵⁾	V _{EN} = 1.8V		0.8	3	μA
F _S	Switching Frequency	V _{IN} = 3V	0.9	1.25	1.6	MHz
V _{Fb-Sw2}	Feedback Pin Voltage ⁽⁶⁾		0.459	0.51	0.561	V
I _{Fb}	Feedback Pin Bias Current ⁽⁵⁾			0.03	2	μA
D _{MAX}	Maximum Duty Cycle	V _{IN} = 3V	85	90		%

- (1) All voltages are with respect to the potential at the GND pin.
- (2) Min and Max limits are guaranteed by design, test, or statistical analysis. Typical numbers are not guaranteed, but do represent the most likely norm.
- (3) The Power Switch Current Limit is tested in open loop configuration. For closed loop application current limit please see the Current Limit vs Temperature performance graph.
- (4) The on threshold indicates that the LM3557 is no longer switching or regulating LED current, while the off threshold indicates normal operation.
- (5) Current flows into the pin.
- (6) Feedback pin voltage is with respect to the voltage at the Sw2 pin.

Electrical Characteristics (1) (2) (continued)

Limits in standard typeface are for $T_J = 25^\circ\text{C}$. Limits in **bold typeface** apply over the full operating junction temperature range ($-40^\circ\text{C} \leq T_J \leq +125^\circ\text{C}$). Unless otherwise specified: $V_{IN} = 3.6\text{V}$.

Parameter	Test Conditions	Min	Typ	Max	Units
I_{LSW1}	Sw1 Pin Leakage Current ⁽⁵⁾		0.002	2	μA
I_{LSW2}	Sw2 Pin Leakage Current ⁽⁵⁾		0.001	1	μA
I_{LOVP}	Ovp Pin Leakage Current ⁽⁵⁾		2		nA
R_{SW2}	Sw2 Pin Switch Resistance		8	10	Ω
$TC(R_{SW2})$	R_{SW2} Temperature Coefficient		0.5		%/C

BLOCK DIAGRAM

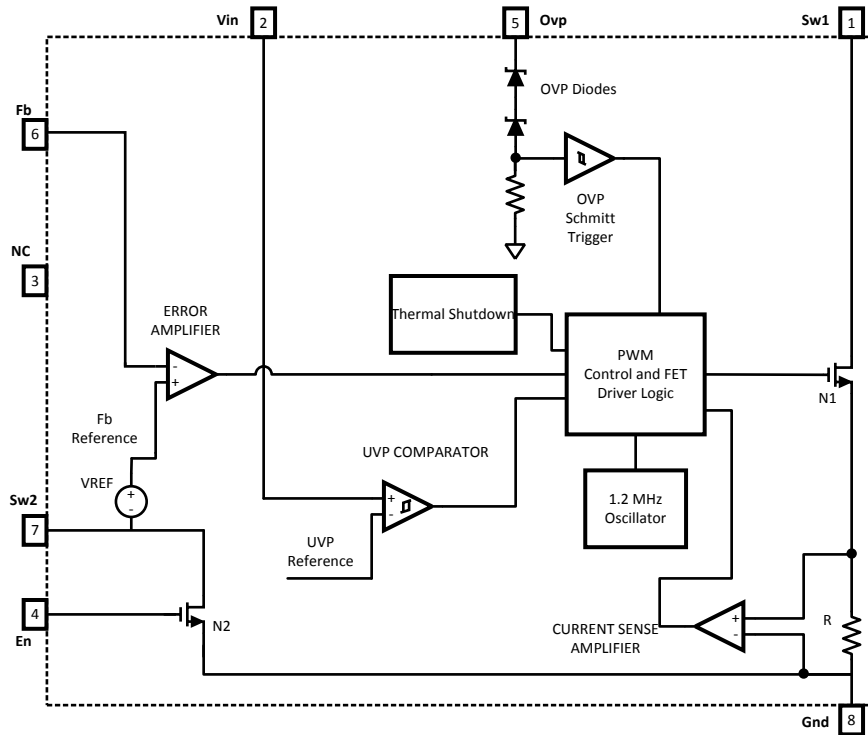

Figure 3.

OPERATION

The LM3557 is a current-mode controlled constant-frequency step-up converter optimized for the facilitation of white LED driving/current biasing.

The LM3557's operation can be best understood by the following device functionality explanation. For the following device functionality explanation, the block diagram in [Figure 3](#) serves as a functional schematic representation of the underlying circuit blocks that make up the LM3557. When the feedback voltage falls below, or rises above, the internal reference voltage, the error amplifier outputs a signal that is translated into the correct amount of stored energy within the inductor that is required to put the feedback voltage back into regulation when the stored inductor energy is then transferred to the load. The aforementioned translation is a conversion of the error amplifier's output signal to the proper on-time duration of the N1 power field effect transistor (FET). This conversion allows the inductor's stored energy to increase, or decrease, to a sufficient level that when transferred to the load will bring the feedback voltage back into regulation.

An increase in inductor current corresponds to an increase in the amount of stored energy within the inductor. Conversely, a decrease in inductor current corresponds to a decrease in the amount of stored energy. The inductor's stored energy is released, or transferred, to the load when the N1 power FET is turned off. The transferred inductor energy replenishes the output capacitor and keeps the white LED current regulated at the designated magnitude that is based on the choice of the R2 resistor. When the N1 power FET is turned on, the energy stored within the inductor begins to increase while the output capacitor discharges through the series string of white LEDs, the R2 resistance, and N2 FET switch to ground. Therefore, each switching cycle consist of some amount of energy being stored in the inductor that is then released, or transferred, to the load to keep the voltage at the feedback pin in regulation at 510 mV above the Sw2 pin voltage.

Features:

CYCLE-BY-CYCLE CURRENT LIMIT

The current through the internal power FET ([Figure 3](#): N1) is monitored to prevent peak inductor currents from damaging the part. If during a cycle (cycle = 1/switching frequency) the peak inductor current exceeds the current limit rating for the LM3557, the internal power FET would be forcibly turned off for the remaining duration of that cycle.

OVER-VOLTAGE PROTECTION

When the output voltage exceeds the over-voltage protection (OVP) threshold, the LM3557's internal power FET will be forcibly turned off until the output voltage falls below the over-voltage protection threshold minus the 500 mV hysteresis of the internal OVP circuitry.

UNDER-VOLTAGE PROTECTION

When the input voltage falls below the under-voltage protection (UVP) threshold, the LM3557's internal power FET will be forcibly turned off until the input voltage is above the designated under-voltage protection threshold plus the 100 mV hysteresis of the internal UVP circuitry.

TRUE SHUTDOWN

When the LM3557 is put into shutdown mode operation there are no DC current paths to ground. The internal FET ([Figure 3](#): N2) at the Sw2 pin turns off, leaving the white LED string open circuited.

THERMAL SHUTDOWN

When the internal semiconductor junction temperature reaches approximately 150°C, the LM3557's internal power FET ([Figure 3](#): N1) will be forcibly turned off.

TYPICAL PERFORMANCE CHARACTERISTICS

(Circuit in Figure 1: L = DO1608C-223, D = SS16, and LED = LWT67C. Efficiency: $\eta = P_{OUT}/P_{IN} = [(V_{OUT} - V_{FB}) * I_{OUT}]/[V_{IN} * I_{IN}]$. $T_A = 25^\circ\text{C}$, unless otherwise stated).

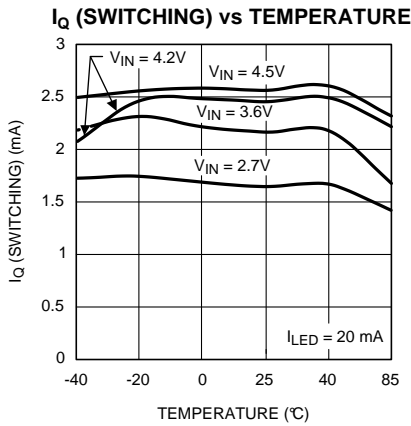

Figure 4.

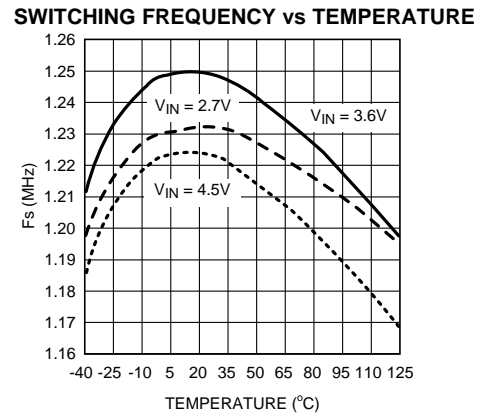

Figure 5.

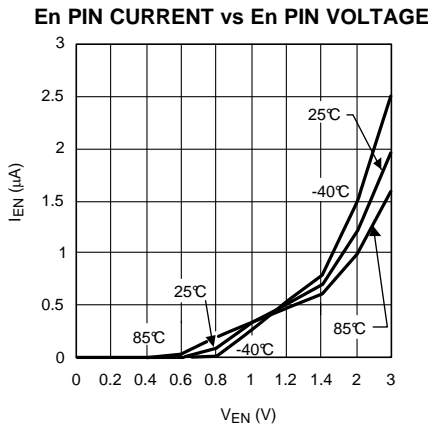

Figure 6.

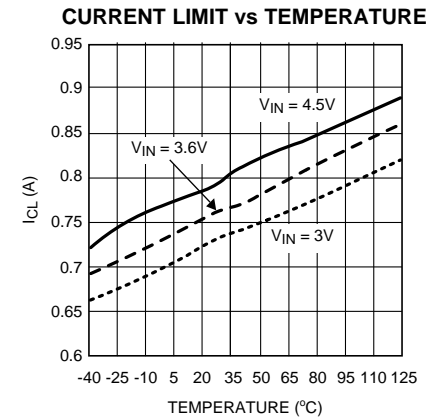

Figure 7.

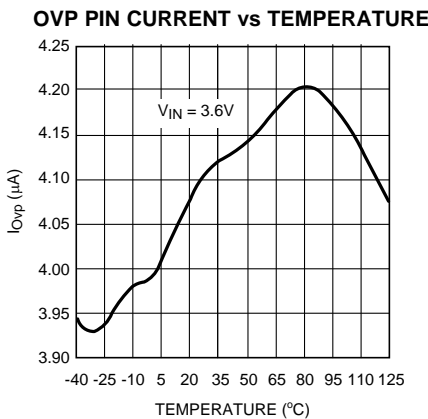

Figure 8.

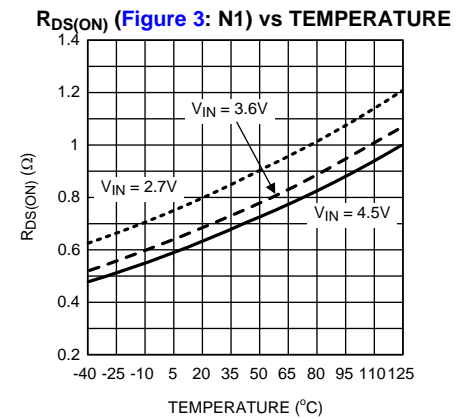

Figure 9.

TYPICAL PERFORMANCE CHARACTERISTICS (continued)

(Circuit in [Figure 1](#): L = DO1608C-223, D = SS16, and LED = LWT67C. Efficiency: $\eta = P_{OUT}/P_{IN} = [(V_{OUT} - V_{FB}) * I_{OUT}]/[V_{IN} * I_{IN}]$. $T_A = 25^\circ\text{C}$, unless otherwise stated).

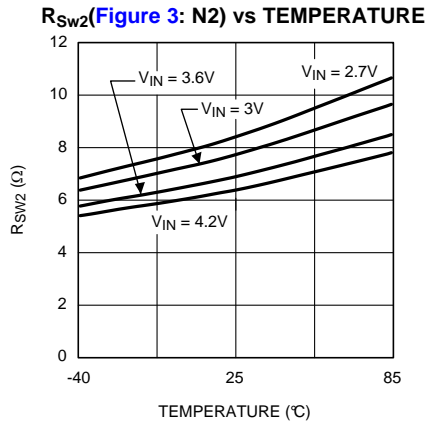

Figure 10.

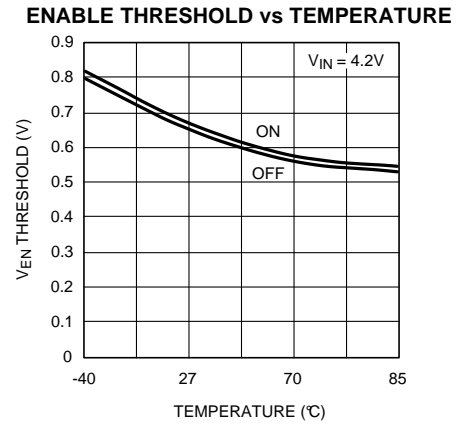

Figure 11.

APPLICATION INFORMATION

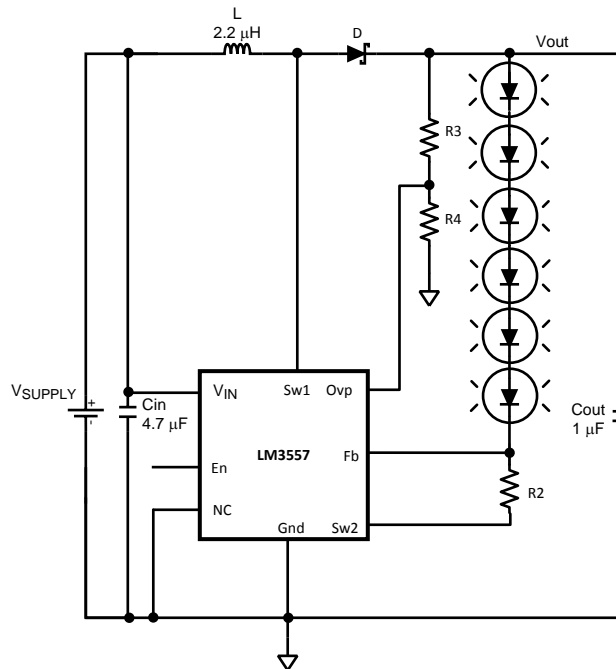

Figure 12. Programmable Output Voltage

WHITE LED CURRENT SETTING

For backlighting applications, the white LED current is programmed by the careful choice of the R2 resistor.

Backlight:

$$V_{En} \geq 0.9V \quad (1)$$

$$I_{LED} = \frac{V_{Fb-Sw2}}{R2}$$

where

- I_{LED} white LED current
- V_{Fb-Sw2} is the feedback voltage
- R2 is the resistor

(2)

The feedback voltage is with respect to the voltage at the Sw2 pin, not ground. For example, if the voltage on the Sw2 pin were 0.1V then the voltage at the Fb pin would be 0.61V (typical).

ADJUSTING LED CURRENT USING PWM SIGNAL

The LED current can be controlled using a PWM signal on the EN pin with frequencies in the range of 100Hz (greater than visible frequency spectrum) to 1kHz. For controlling LED currents down to the μA levels, it is best to use a PWM signal frequency between 200-500Hz. The LM3557 LED current can be controlled with PWM signal frequencies above 1kHz but the controllable current decreases with higher frequency.

ADJUSTING OVER-VOLTAGE PROTECTION

If the over-voltage protection (OVP) threshold is too low for a particular application, a resistor divider circuit can be used to adjust the OVP threshold of a given application. Instead of having the Ovp pin connected to the output voltage, it can be adjusted through a resistor divider circuit to only experience a fraction of the output voltage magnitude. The resistor divider circuit bias current should be at least 100 times greater than the Ovp pin bias current. Using [Figure 12](#), the following equation can be used to adjust the output voltage:

$$V_{out} = \frac{[R4 + R3]}{[R4]} \times V_{Ovp}$$

where

- V_{OVP} is the OVP voltage threshold
- V_{OUT} is the maximum output voltage (<35V)
- R3 is a resistor
- R4 is a resistor

(3)

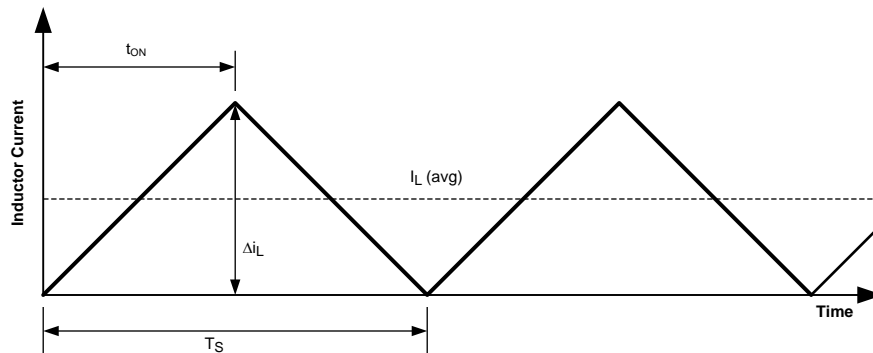

Figure 13. Inductor Current Waveform

CONTINUOUS AND DISCONTINUOUS MODES OF OPERATION

Since the LM3557 is a constant frequency pulse-width-modulated step-up regulator, care must be taken to make sure the maximum duty cycle specification is not violated. The duty cycle equation depends on which mode of operation the LM3557 is in. The two operational modes of the LM3557 are continuous conduction mode (CCM) and discontinuous conduction mode (DCM). Continuous conduction mode refers to the mode of operation where during the switching cycle, the inductor's current never goes to and stays at zero for any significant amount of time during the switching cycle. Discontinuous conduction mode refers to the mode of operation where during the switching cycle, the inductor's current goes to and stays at zero for a significant amount of time during the switching cycle. Figure 13 illustrates the threshold between CCM and DCM operation. In Figure 13, the inductor current is right on the CCM/DCM operational threshold. Using this as a reference, a factor can be introduced to calculate when a particular application is in CCM or DCM operation. R is a CCM/DCM factor we can use to compute which mode of operation a particular application is in. If $R \geq 1$, then the application is operating in CCM. Conversely, if $R < 1$, the application is operating in DCM. The R factor inequalities are a result of the components that make up the R factor. From Figure 13, the R factor is equal to the average inductor current, $I_L(\text{avg})$, divided by half the inductor ripple current, Δi_L . Using Figure 13, the following equation can be used to compute R factor:

$$R = \frac{2 \times I_L(\text{avg})}{\Delta i_L} \tag{4}$$

$$I_L(\text{avg}) = \frac{[I_{OUT}]}{[(1-D) \times \text{Eff}]} \tag{5}$$

$$\Delta i_L = \frac{[V_{IN} \times D]}{[L \times F_s]} \tag{6}$$

$$R = \frac{[2 \times I_{OUT} \times L \times F_s \times (V_{OUT})^2]}{[(V_{IN})^2 \times \text{Eff} \times (V_{OUT} - V_{IN})]}$$

where

- V_{IN} is the input voltage
- V_{OUT} is the output voltage
- Eff is the efficiency of the LM3557
- F_s is the switching frequency
- I_{OUT} is the white LED current/load current
- L is the inductance magnitude/inductor value
- D is the duty cycle for CCM operation
- Δi_L is the inductor ripple current
- $I_{L(\text{avg})}$ is the average inductor current

(7)

For CCM operation, the duty cycle can be computed with:

$$D = \frac{t_{ON}}{T_S} \tag{8}$$

$$D = \frac{[V_{OUT} - V_{IN}]}{[V_{OUT}]}$$

where

- t_{ON} is the internal power FET on-time
- T_S is the switching period of operation
- D is the duty cycle for CCM operation
- V_{IN} is the input voltage
- V_{OUT} is the output voltage

(9)

For DCM operation, the duty cycle can be computed with:

$$D = \frac{t_{ON}}{T_S} \tag{10}$$

$$D = \sqrt{\frac{[2 \times I_{OUT} \times L \times (V_{OUT} - V_{IN}) \times F_s]}{[(V_{IN})^2 \times \text{Eff}]}}$$

where

- t_{ON} is the internal power FET on-time
- T_S is the switching period of operation
- D is the duty cycle for CCM operation
- V_{IN} is the input voltage
- V_{OUT} is the output voltage
- Eff is the efficiency of the LM3557
- F_s is the switching frequency
- I_{OUT} is the white LED current/load current
- L is the inductance magnitude/inductor value

(11)

INDUCTOR SELECTION

In order to maintain inductance, an inductor used with the LM3557 should have a saturation current rating larger than the peak inductor current of the particular application. Inductors with low DCR values contribute decreased power losses and increased efficiency. The peak inductor current can be computed for both modes of operation: CCM (continuous current mode) and DCM (discontinuous current mode).

The cycle-by-cycle peak inductor current for CCM operation can be computed with:

$$I_{\text{Peak}} \approx I_L (\text{avg}) + \frac{\Delta i_L}{2} \quad (12)$$

$$I_{\text{Peak}} \approx \frac{[I_{\text{OUT}}]}{[(1 - D) * \text{Eff}]} + \frac{[V_{\text{IN}} * D]}{[2 * L * F_s]}$$

where

- V_{IN} is the input voltage
 - V_{OUT} is the output voltage
 - Eff is the efficiency of the LM3557
 - F_s is the switching frequency
 - I_{OUT} is the white LED current/load current
 - L is the inductance magnitude/inductor value
 - D is the duty cycle for CCM operation
 - Δi_L is the inductor ripple current
 - $I_{L(\text{avg})}$ is the average inductor current
- (13)

The cycle-by-cycle peak inductor current for DCM operation can be computed with:

$$I_{\text{Peak}} \approx \frac{[V_{\text{IN}} * D]}{[L * F_s]}$$

where

- V_{IN} is the input voltage
 - V_{OUT} is the output voltage
 - Eff is the efficiency of the LM3557
 - F_s is the switching frequency
 - I_{OUT} is the white LED current/load current
 - L is the inductance magnitude/inductor value
 - D is the duty cycle for CCM operation
 - Δi_L is the inductor ripple current
 - $I_{L(\text{avg})}$ is the average inductor current
- (14)

Some recommended inductor manufacturers are:

Coilcraft [www.coilcraft.com]

Coiltronics [www.cooperet.com]

TDK [www.tdk.com]

CAPACITOR SELECTION

Multilayer ceramic capacitors are the best choice for use with the LM3557. Multilayer ceramic capacitors have the lowest equivalent series resistance (ESR). Applied voltage or DC bias, temperature, dielectric material type (X7R, X5R, Y5V, etc), and manufacturer component tolerance have an affect on the true or effective capacitance of a ceramic capacitor. Be aware of how your application will affect a particular ceramic capacitor by analyzing the aforementioned factors of your application. Before selecting a capacitor always consult the capacitor manufacturer's data curves to verify the effective or true capacitance of the capacitor in your application.

INPUT CAPACITOR SELECTION

The input capacitor serves as an energy reservoir for the inductor. In addition to acting as an energy reservoir for the inductor the input capacitor is necessary for the reduction in input voltage ripple and noise experienced by the LM3557. The reduction in input voltage ripple and noise helps ensure the LM3557's proper operation, and reduces the effect of the LM3557 on other devices sharing the same supply voltage. To ensure low input voltage ripple, the input capacitor must have an extremely low ESR. As a result of the low input voltage ripple requirement multilayer ceramic capacitors are the best choice. A minimum capacitance of 2.0 μF is required for normal operation, consult the capacitor manufacturer's data curves to verify whether the minimum capacitance requirement is going to be achieved for a particular application.

OUTPUT CAPACITOR SELECTION

The output capacitor serves as an energy reservoir for the white LED load when the internal power FET switch (Figure 3: N1) is ON or conducting current. The requirements for the output capacitor must include worst case operation such as when the load opens up and the LM3557 operates in over-voltage protection (OVP) mode operation. A minimum capacitance of 0.5 μF is required to ensure normal operation. Consult the capacitor manufacturer's data curves to verify whether the minimum capacitance requirement is going to be achieved for a particular application.

Some recommended capacitor manufacturers are:

TDK

[www.tdk.com]

Murata

[www.murata.com]

Vishay

[www.vishay.com]

DIODE SELECTION

To maintain high efficiency it is recommended that the average current rating (I_F or I_O) of the selected diode should be larger than the peak inductor current ($I_{L\text{peak}}$). To maintain diode integrity the peak repetitive forward current (I_{FRM}) must be greater than or equal to the peak inductor current ($I_{L\text{peak}}$). Diodes with low forward voltage ratings (V_F) and low junction capacitance magnitudes (C_J or C_T or C_D) are conducive to high efficiency. The chosen diode must have a reverse breakdown voltage rating (V_R and/or V_{RRM}) that is larger than the output voltage (V_{OUT}). No matter what type of diode is chosen, Schottky or not, certain selection criteria must be followed:

1. V_R and $V_{RRM} > V_{OUT}$
2. I_F or $I_O \geq I_{LOAD}$ or I_{OUT}
3. $I_{FRM} \geq I_{L\text{peak}}$

Some recommended diode manufacturers are as follows:

Vishay [www.vishay.com]

Diodes, Inc [www.diodes.com]

On Semiconductor [www.onsemi.com]

LAYOUT CONSIDERATIONS

All components, except for the white LEDs, must be placed as close as possible to the LM3557. The die attach pad (DAP) must be soldered to the ground plane.

The input capacitor, C_{in} , must be placed close to the LM3557. Placing C_{in} close to the device will reduce the metal trace resistance effect on input voltage ripple. The feedback current setting resistor R_2 must be placed close to the Fb and Sw2 pins. The output capacitor, C_{out} , must be placed close to the Ovp and Gnd pin connections. Trace connections to the inductor should be short and wide to reduce power dissipation, increase overall efficiency, and reduce EMI radiation. The diode, like the inductor, should have trace connections that are short and wide to reduce power dissipation and increase overall efficiency. For more details regarding layout guidelines for switching regulators refer to Applications Note AN-1149 (SNVA021).

REVISION HISTORY

Changes from Revision A (February 2013) to Revision B	Page
<hr/> <ul style="list-style-type: none">• Changed layout of National Data Sheet to TI format	<hr/> 12

PACKAGING INFORMATION

Orderable Device	Status (1)	Package Type	Package Drawing	Pins	Package Qty	Eco Plan (2)	Lead/Ball Finish	MSL Peak Temp (3)	Op Temp (°C)	Top-Side Markings (4)	Samples
LM3557SD-2	ACTIVE	WSON	NGQ	8	1000	TBD	Call TI	Call TI	-40 to 85	L147B	Samples
LM3557SD-2/NOPB	ACTIVE	WSON	NGQ	8	1000	Green (RoHS & no Sb/Br)	CU SN	Level-1-260C-UNLIM	-40 to 85	L147B	Samples
LM3557SDX-2	ACTIVE	WSON	NGQ	8	4500	TBD	Call TI	Call TI	-40 to 85	L147B	Samples
LM3557SDX-2/NOPB	ACTIVE	WSON	NGQ	8	4500	Green (RoHS & no Sb/Br)	CU SN	Level-1-260C-UNLIM	-40 to 85	L147B	Samples

(1) The marketing status values are defined as follows:

ACTIVE: Product device recommended for new designs.

LIFEBUY: TI has announced that the device will be discontinued, and a lifetime-buy period is in effect.

NRND: Not recommended for new designs. Device is in production to support existing customers, but TI does not recommend using this part in a new design.

PREVIEW: Device has been announced but is not in production. Samples may or may not be available.

OBSOLETE: TI has discontinued the production of the device.

(2) Eco Plan - The planned eco-friendly classification: Pb-Free (RoHS), Pb-Free (RoHS Exempt), or Green (RoHS & no Sb/Br) - please check <http://www.ti.com/productcontent> for the latest availability information and additional product content details.

TBD: The Pb-Free/Green conversion plan has not been defined.

Pb-Free (RoHS): TI's terms "Lead-Free" or "Pb-Free" mean semiconductor products that are compatible with the current RoHS requirements for all 6 substances, including the requirement that lead not exceed 0.1% by weight in homogeneous materials. Where designed to be soldered at high temperatures, TI Pb-Free products are suitable for use in specified lead-free processes.

Pb-Free (RoHS Exempt): This component has a RoHS exemption for either 1) lead-based flip-chip solder bumps used between the die and package, or 2) lead-based die adhesive used between the die and leadframe. The component is otherwise considered Pb-Free (RoHS compatible) as defined above.

Green (RoHS & no Sb/Br): TI defines "Green" to mean Pb-Free (RoHS compatible), and free of Bromine (Br) and Antimony (Sb) based flame retardants (Br or Sb do not exceed 0.1% by weight in homogeneous material)

(3) MSL, Peak Temp. -- The Moisture Sensitivity Level rating according to the JEDEC industry standard classifications, and peak solder temperature.

(4) Multiple Top-Side Markings will be inside parentheses. Only one Top-Side Marking contained in parentheses and separated by a "~" will appear on a device. If a line is indented then it is a continuation of the previous line and the two combined represent the entire Top-Side Marking for that device.

Important Information and Disclaimer: The information provided on this page represents TI's knowledge and belief as of the date that it is provided. TI bases its knowledge and belief on information provided by third parties, and makes no representation or warranty as to the accuracy of such information. Efforts are underway to better integrate information from third parties. TI has taken and continues to take reasonable steps to provide representative and accurate information but may not have conducted destructive testing or chemical analysis on incoming materials and chemicals. TI and TI suppliers consider certain information to be proprietary, and thus CAS numbers and other limited information may not be available for release.

In no event shall TI's liability arising out of such information exceed the total purchase price of the TI part(s) at issue in this document sold by TI to Customer on an annual basis.

TAPE AND REEL INFORMATION



QUADRANT ASSIGNMENTS FOR PIN 1 ORIENTATION IN TAPE



*All dimensions are nominal

Device	Package Type	Package Drawing	Pins	SPQ	Reel Diameter (mm)	Reel Width W1 (mm)	A0 (mm)	B0 (mm)	K0 (mm)	P1 (mm)	W (mm)	Pin1 Quadrant
LM3557SD-2	WSON	NGQ	8	1000	178.0	12.4	3.3	3.3	1.0	8.0	12.0	Q1
LM3557SD-2/NOPB	WSON	NGQ	8	1000	178.0	12.4	3.3	3.3	1.0	8.0	12.0	Q1
LM3557SDX-2	WSON	NGQ	8	4500	330.0	12.4	3.3	3.3	1.0	8.0	12.0	Q1
LM3557SDX-2/NOPB	WSON	NGQ	8	4500	330.0	12.4	3.3	3.3	1.0	8.0	12.0	Q1

TAPE AND REEL BOX DIMENSIONS

*All dimensions are nominal

Device	Package Type	Package Drawing	Pins	SPQ	Length (mm)	Width (mm)	Height (mm)
LM3557SD-2	WSON	NGQ	8	1000	203.0	190.0	41.0
LM3557SD-2/NOPB	WSON	NGQ	8	1000	203.0	190.0	41.0
LM3557SDX-2	WSON	NGQ	8	4500	367.0	367.0	35.0
LM3557SDX-2/NOPB	WSON	NGQ	8	4500	367.0	367.0	35.0

NGQ0008A

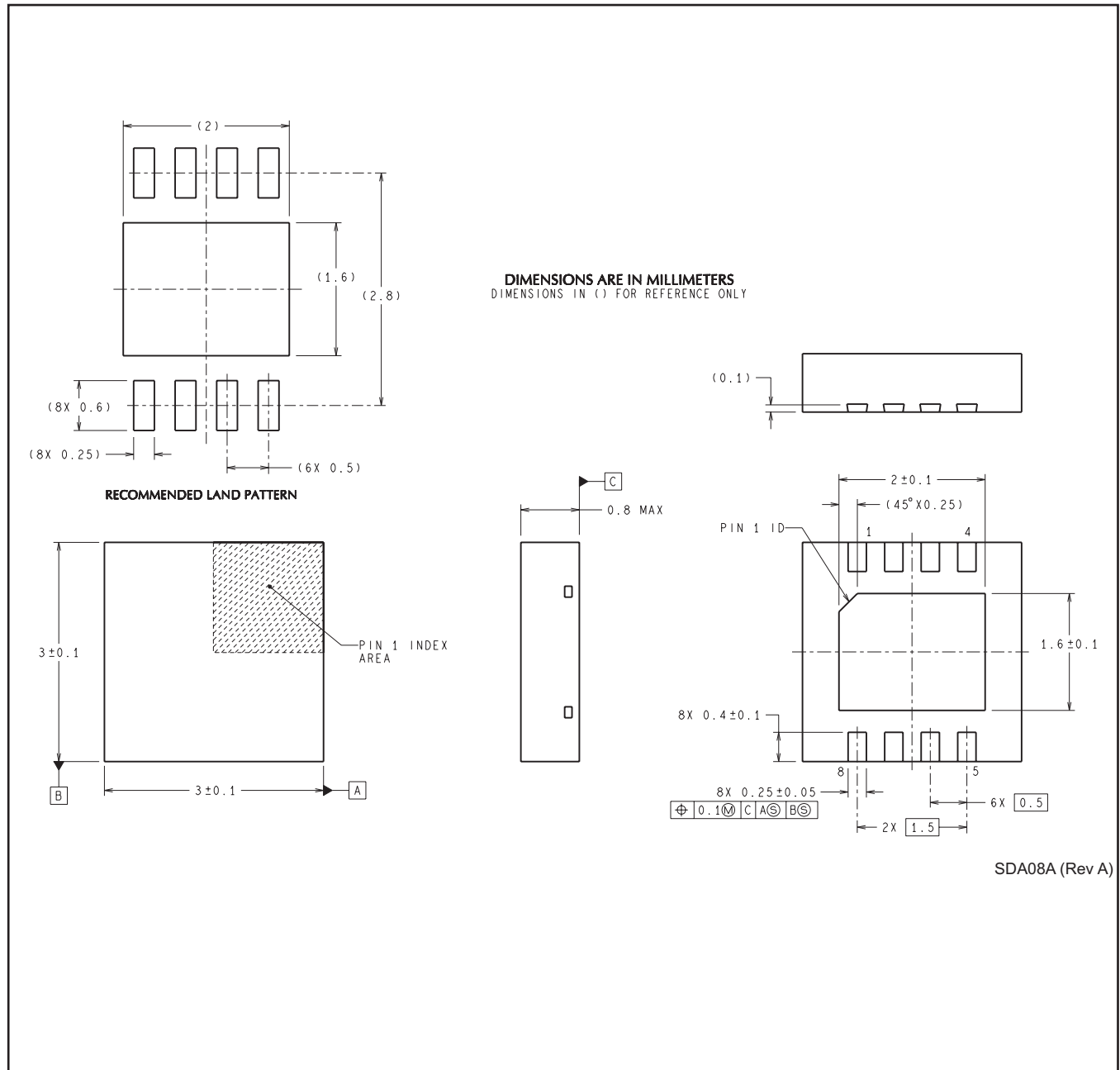

IMPORTANT NOTICE

Texas Instruments Incorporated and its subsidiaries (TI) reserve the right to make corrections, enhancements, improvements and other changes to its semiconductor products and services per JESD46, latest issue, and to discontinue any product or service per JESD48, latest issue. Buyers should obtain the latest relevant information before placing orders and should verify that such information is current and complete. All semiconductor products (also referred to herein as "components") are sold subject to TI's terms and conditions of sale supplied at the time of order acknowledgment.

TI warrants performance of its components to the specifications applicable at the time of sale, in accordance with the warranty in TI's terms and conditions of sale of semiconductor products. Testing and other quality control techniques are used to the extent TI deems necessary to support this warranty. Except where mandated by applicable law, testing of all parameters of each component is not necessarily performed.

TI assumes no liability for applications assistance or the design of Buyers' products. Buyers are responsible for their products and applications using TI components. To minimize the risks associated with Buyers' products and applications, Buyers should provide adequate design and operating safeguards.

TI does not warrant or represent that any license, either express or implied, is granted under any patent right, copyright, mask work right, or other intellectual property right relating to any combination, machine, or process in which TI components or services are used. Information published by TI regarding third-party products or services does not constitute a license to use such products or services or a warranty or endorsement thereof. Use of such information may require a license from a third party under the patents or other intellectual property of the third party, or a license from TI under the patents or other intellectual property of TI.

Reproduction of significant portions of TI information in TI data books or data sheets is permissible only if reproduction is without alteration and is accompanied by all associated warranties, conditions, limitations, and notices. TI is not responsible or liable for such altered documentation. Information of third parties may be subject to additional restrictions.

Resale of TI components or services with statements different from or beyond the parameters stated by TI for that component or service voids all express and any implied warranties for the associated TI component or service and is an unfair and deceptive business practice. TI is not responsible or liable for any such statements.

Buyer acknowledges and agrees that it is solely responsible for compliance with all legal, regulatory and safety-related requirements concerning its products, and any use of TI components in its applications, notwithstanding any applications-related information or support that may be provided by TI. Buyer represents and agrees that it has all the necessary expertise to create and implement safeguards which anticipate dangerous consequences of failures, monitor failures and their consequences, lessen the likelihood of failures that might cause harm and take appropriate remedial actions. Buyer will fully indemnify TI and its representatives against any damages arising out of the use of any TI components in safety-critical applications.

In some cases, TI components may be promoted specifically to facilitate safety-related applications. With such components, TI's goal is to help enable customers to design and create their own end-product solutions that meet applicable functional safety standards and requirements. Nonetheless, such components are subject to these terms.

No TI components are authorized for use in FDA Class III (or similar life-critical medical equipment) unless authorized officers of the parties have executed a special agreement specifically governing such use.

Only those TI components which TI has specifically designated as military grade or "enhanced plastic" are designed and intended for use in military/aerospace applications or environments. Buyer acknowledges and agrees that any military or aerospace use of TI components which have **not** been so designated is solely at the Buyer's risk, and that Buyer is solely responsible for compliance with all legal and regulatory requirements in connection with such use.

TI has specifically designated certain components as meeting ISO/TS16949 requirements, mainly for automotive use. In any case of use of non-designated products, TI will not be responsible for any failure to meet ISO/TS16949.

Products

Audio	www.ti.com/audio
Amplifiers	amplifier.ti.com
Data Converters	dataconverter.ti.com
DLP® Products	www.dlp.com
DSP	dsp.ti.com
Clocks and Timers	www.ti.com/clocks
Interface	interface.ti.com
Logic	logic.ti.com
Power Mgmt	power.ti.com
Microcontrollers	microcontroller.ti.com
RFID	www.ti-rfid.com
OMAP Applications Processors	www.ti.com/omap
Wireless Connectivity	www.ti.com/wirelessconnectivity

Applications

Automotive and Transportation	www.ti.com/automotive
Communications and Telecom	www.ti.com/communications
Computers and Peripherals	www.ti.com/computers
Consumer Electronics	www.ti.com/consumer-apps
Energy and Lighting	www.ti.com/energy
Industrial	www.ti.com/industrial
Medical	www.ti.com/medical
Security	www.ti.com/security
Space, Avionics and Defense	www.ti.com/space-avionics-defense
Video and Imaging	www.ti.com/video

TI E2E Community

e2e.ti.com