

# SM72445 Programmable Maximum Power Point Tracking Controller With Adjustable PWM Frequency

Check for Samples: [SM72445](#)

## FEATURES

- Renewable Energy Grade
- 110kHz, 135kHz or 215kHz PWM Operating Frequency
- Panel Mode Pin for Optional Bypass Switch Control
- Programmable Maximum Power Point Tracking
- Photovoltaic Solar Panel Voltage and Current Diagnostic
- Single Inductor Four Switch Buck-Boost Converter Control
- I2C Interface for Communication
- Output Overvoltage Protection
- Over-Current Protection

## PACKAGE

- TSSOP-28

## DESCRIPTION

The SM72445 is a programmable MPPT controller capable of controlling four PWM gate drive signals for a 4-switch buck-boost converter. The SM72445 also features a proprietary algorithm called Panel Mode (PM) which allows for the panel to be connected directly to the output of the power optimizer circuit when the input to output voltage ratio is close to 1. This provides an opportunity to optimize the efficiency of the power optimizer when the load is naturally matching the maximum power point of the panel. Along with the SM72295 (Photovoltaic Full Bridge Driver), it creates a solution for an MPPT configured DC-DC converter with efficiencies up to 99.5% (when operating with dedicated PM switches). Integrated into the chip is an 8-channel, 10 bit A/D converter used to sense input and output voltages and currents, as well as IC configuration. Externally programmable values include maximum output voltage and current as well as different settings for slew rate, soft-start and Panel Mode.

## BLOCK DIAGRAM

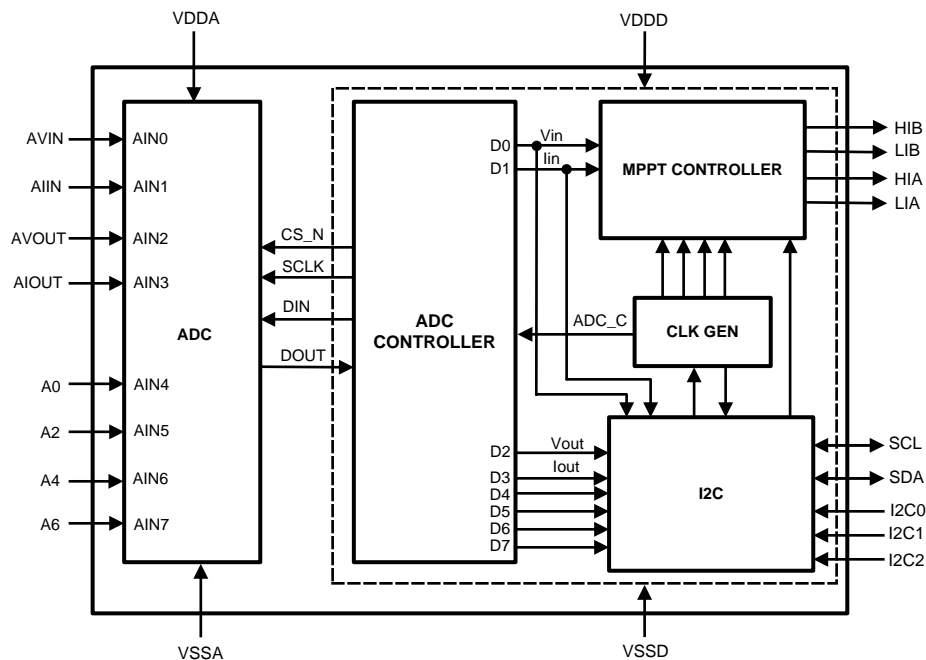

Figure 1. Block Diagram



Please be aware that an important notice concerning availability, standard warranty, and use in critical applications of Texas Instruments semiconductor products and disclaimers thereto appears at the end of this data sheet.

All trademarks are the property of their respective owners.

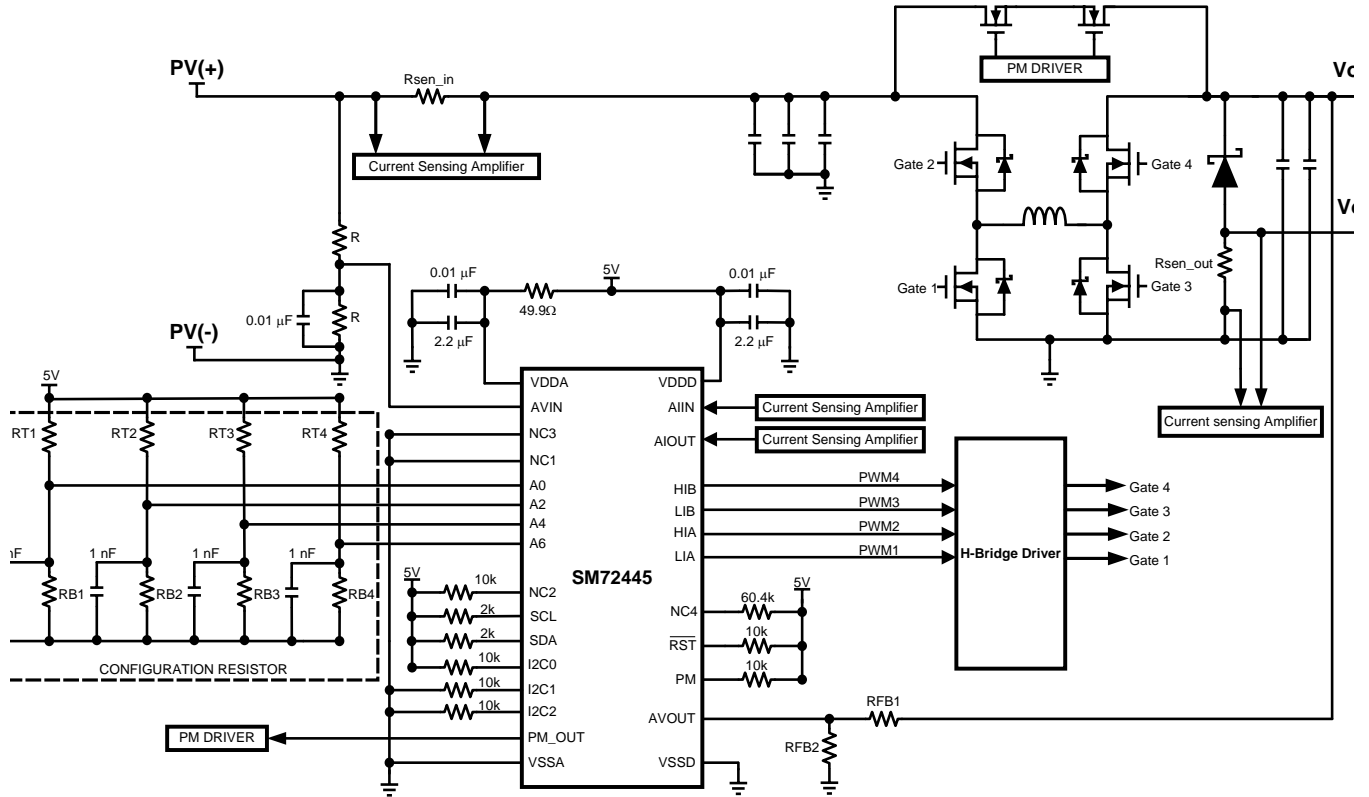

Figure 2. Typical Application Circuit

CONNECTION DIAGRAM

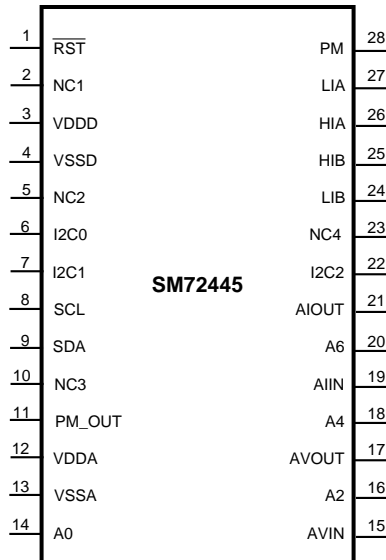

Figure 3. Top View - TSSOP-28

### PIN DESCRIPTIONS

Pin	Name	Description
1	$\overline{\text{RST}}$	Active low signal. External reset input signal to the digital circuit.
2	NC1	Reserved for test only. This pin should be grounded.
3	VDDD	Digital supply voltage. This pin should be connected to a 5V supply, and bypassed to VSSD with a 0.1 $\mu\text{F}$ monolithic ceramic capacitor.
4	VSSD	Digital ground. The ground return for the digital supply and signals.
5	NC2	This pin should be pulled up to the 5V supply using a 10k resistor.
6	I2C0	Addressing for I2C communication.
7	I2C1	Addressing for I2C communication.
8	SCL	I2C clock.
9	SDA	I2C data.
10	NC3	Reserved for test only. This pin should be grounded.
11	PM_OUT	When Panel Mode is active, this pin will output a 440 kHz square wave signal with amplitude of 5V. Otherwise, it stays low.
12	VDDA	Analog supply voltage. This voltage is also used as the reference voltage. This pin should be connected to a 5V supply, and bypassed to VSSA with a 1 $\mu\text{F}$ and 0.1 $\mu\text{F}$ monolithic ceramic capacitor.
13	VSSA	Analog ground. The ground return for the analog supply and signals.
14	A0	A/D Input Channel 0. Connect a resistor divider to 5V supply to set the maximum output voltage. Please refer to the <a href="#">application</a> section for more information on setting the resistor value.
15	AVIN	Input voltage sensing pin.
16	A2	A/D Input Channel 2. Connect a resistor divider to a 5V supply to set the condition to enter and exit Panel Mode (PM). Refer to the <a href="#">Configurable Settings</a> section.
17	AVOUT	Output voltage sensing pin.
18	A4	A/D Input Channel 4. Connect a resistor divider to a 5V supply to set the maximum output current. Please refer to the <a href="#">application</a> section for more information on setting the resistor value.
19	AIIN	Input current sensing pin.
20	A6	A/D Input Channel 6. Connect a resistor divider to a 5V supply to set the output voltage slew rate and various PM configurations. Refer to the <a href="#">Configurable Settings</a> section.
21	AIOUT	Output current sensing pin.
22	I2C2	Addressing for I2C communication.
23	NC4	This pin should be connected with a 60.4k pull-up resistor to 5V.
24	LIB	Low side boost PWM output.
25	HIB	High side boost PWM output.
26	HIA	High side buck PWM output.
27	LIA	Low side buck PWM output.
28	PM	Panel Mode Pin. Active low. Pulling this pin low will force the chip into Panel Mode.



These devices have limited built-in ESD protection. The leads should be shorted together or the device placed in conductive foam during storage or handling to prevent electrostatic damage to the MOS gates.

**ABSOLUTE MAXIMUM RATINGS** <sup>(1)(2)</sup>

Analog Supply Voltage $V_A$ (VDDA - VSSA)	-0.3 to 6.0V
Digital Supply Voltage $V_D$ (VDDD - VSSD)	-0.3 to $V_A + 0.3V$ max 6.0V
Voltage on Any Pin to GND	-0.3 to $V_A + 0.3V$
Input Current at Any Pin <sup>(3)</sup>	$\pm 10$ mA
Package Input Current <sup>(3)</sup>	$\pm 20$ mA
Storage Temperature Range	-65°C to +150°C
ESD Rating	See <sup>(4)</sup>
Human Body Model	2 kV

- (1) Absolute Maximum Ratings indicate limits beyond which damage to the component may occur. Operating Ratings are conditions under which operation of the device is specified. Operating Ratings do not imply specified performance limits. For specified performance limits and associated test conditions, see the Electrical Characteristics tables.
- (2) If Military/Aerospace specified devices are required, please contact the Texas Instruments Sales Office/ Distributors for availability and specifications.
- (3) Min and Max limits are production tested at 25°C. Limits over the operating temperature range are specified through correlation using Statistical Quality Control (SQC) methods.
- (4) The human body model is a 100 pF capacitor discharged through a 1.5 k $\Omega$  resistor into each pin.

**RECOMMENDED OPERATING CONDITIONS**

Operating Temperature	-40°C to 105°C
$V_A$ Supply Voltage	+4.75V to +5.25V
$V_D$ Supply Voltage	+4.75V to $V_A$
Digital Input Voltage	0 to $V_A$
Analog Input Voltage	0 to $V_A$
Junction Temperature	-40°C to 125°C

**ELECTRICAL CHARACTERISTICS**

Specifications in standard typeface are for  $T_J = 25^\circ\text{C}$ , and those in boldface type apply over the full operating junction temperature range. <sup>(1)</sup> Typical values represent the most likely parametric norm at  $T_J = 25^\circ\text{C}$ , and are provided for reference purposes only. Unless otherwise stated the following conditions apply:  $V_D = V_A = 5V$ .

Symbol	Parameter	Conditions	Min	Typ	Max	Units
<b>ANALOG INPUT CHARACTERISTICS</b>						
$AV_{in}$ , $Al_{in}$ $AV_{out}$ , $Al_{out}$	Input Range		-	0 to $V_A$	-	V
$I_{DCL}$	DC Leakage Current		-	-	<b><math>\pm 1</math></b>	$\mu\text{A}$
$C_{INA}$	Input Capacitance <sup>(2)</sup>	Track Mode	-	33	-	pF
		Hold Mode	-	3	-	pF
<b>DIGITAL INPUT CHARACTERISTICS</b>						
$V_{IL}$	Input Low Voltage		-	-	<b>0.8</b>	V
$V_{IH}$	Input High Voltage		<b>2.8</b>	-	-	V
$C_{IND}$	Digital Input Capacitance <sup>(2)</sup>		-	2	-	pF
$I_{IN}$	Input Current		-	$\pm 0.01$	<b><math>\pm 1</math></b>	$\mu\text{A}$
<b>DIGITAL OUTPUT CHARACTERISTICS</b>						
$V_{OH}$	Output High Voltage	$I_{SOURCE} = 200 \mu\text{A}$	<b><math>V_D - 0.5</math></b>	-	-	V
$V_{OL}$	Output Low Voltage	$I_{SINK} = 200 \mu\text{A}$ to 1.0 mA	-	-	<b>0.4</b>	V
$I_{OZH}$ , $I_{OZL}$	Hi-Impedance Output Leakage Current				<b><math>\pm 1</math></b>	$\mu\text{A}$
$C_{OUT}$	Hi-Impedance Output Capacitance <sup>(2)</sup>			2		pF

- (1) Min and Max limits are production tested at 25°C. Limits over the operating temperature range are specified through correlation using Statistical Quality Control (SQC) methods.
- (2) Not tested. Specified by design.

**ELECTRICAL CHARACTERISTICS (continued)**

Specifications in standard typeface are for  $T_J = 25^\circ\text{C}$ , and those in boldface type apply over the full operating junction temperature range.<sup>(1)</sup> Typical values represent the most likely parametric norm at  $T_J = 25^\circ\text{C}$ , and are provided for reference purposes only. Unless otherwise stated the following conditions apply:  $V_D=V_A=5\text{V}$ .

Symbol	Parameter	Conditions	Min	Typ	Max	Units
<b>POWER SUPPLY CHARACTERISTICS (<math>C_L = 10\text{ pF}</math>)</b>						
$V_A, V_D$	Analog and Digital Supply Voltages	$V_A \geq V_D$	<b>4.75</b>	5	<b>5.25</b>	V
$I_A + I_D$	Total Supply Current		-	11.5	<b>16.5</b>	mA
<b>PWM OUTPUT CHARACTERISTICS</b>						
<b>A2 High Frequency Setting:</b>						
$f_{\text{PWM}}$	PWM switching frequency		170	215	250	kHz
$t_{\text{DEAD}}$	Dead time (for Buck switch node and for Boost switch node)			54		ns
<b>A2 Medium Frequency Setting:</b>						
$f_{\text{PWM}}$	PWM switching frequency		105	135	155	kHz
$t_{\text{DEAD}}$	Dead time			87		ns
<b>A2 Low Frequency Setting:</b>						
$f_{\text{PWM}}$	PWM switching frequency		85	110	125	kHz
$t_{\text{DEAD}}$	Dead time			106		ns

**TYPICAL PERFORMANCE CHARACTERISTICS**

Typical performance curves reflect the performance of the SM72445 as designed into the SM3320–1A1 reference design, and are provided for reference purposes only. Unless otherwise stated the following conditions apply:  $T_J = 25^\circ\text{C}$ .

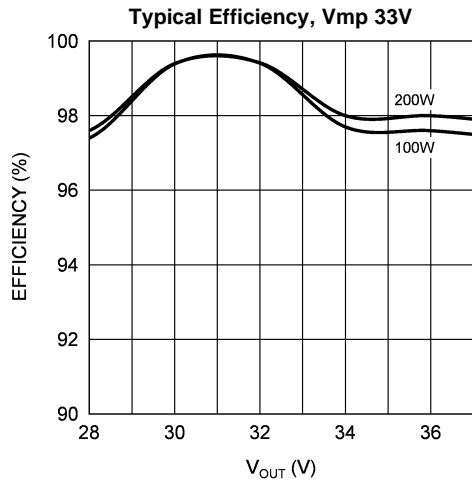

Figure 4.

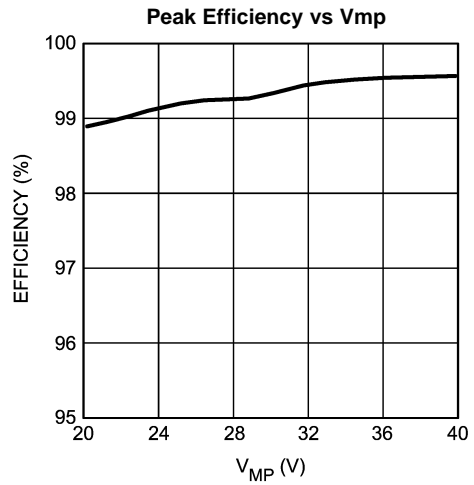

Figure 5.

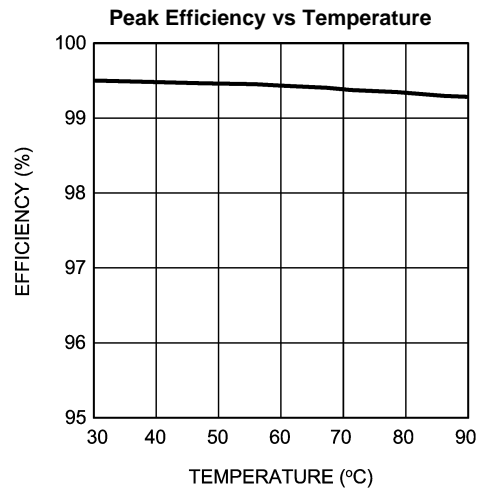

Figure 6.

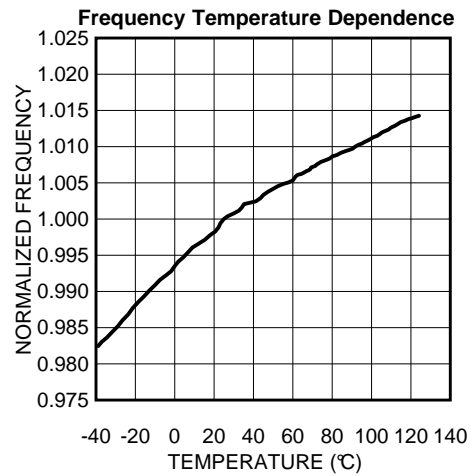

Figure 7.

## OPERATION DESCRIPTION

### OVERVIEW

The SM72445 is a programmable MPPT controller capable of outputting four PWM gate drive signals for a 4 switch buck-boost converter with an independent Panel Mode. The typical application circuit is shown in [Figure 2](#). The SM72445 does not require a dedicated switch to implement Panel Mode. The four buck-boost switches can be controlled to implement PM. A dedicated switch may be used for higher efficiency. Setting the voltage on pin A2 selects between the options.

The SM72445 uses an advanced digital controller to generate its PWM signals. A maximum power point tracking (MPPT) algorithm monitors the input current and voltage and controls the PWM duty cycle to maximize energy harvested from the photovoltaic module. MPPT performance is very fast. Convergence to the maximum power point of the module typically occurs within 0.01s. This enables the controller to maintain optimum performance under fast-changing irradiance conditions.

Transitions between buck, boost, and Panel Mode are smoothed. Output voltage and current limiting functionality are integrated into the digital control logic. The controller is capable of handling both shorted and no-load conditions and will recover smoothly from both conditions.

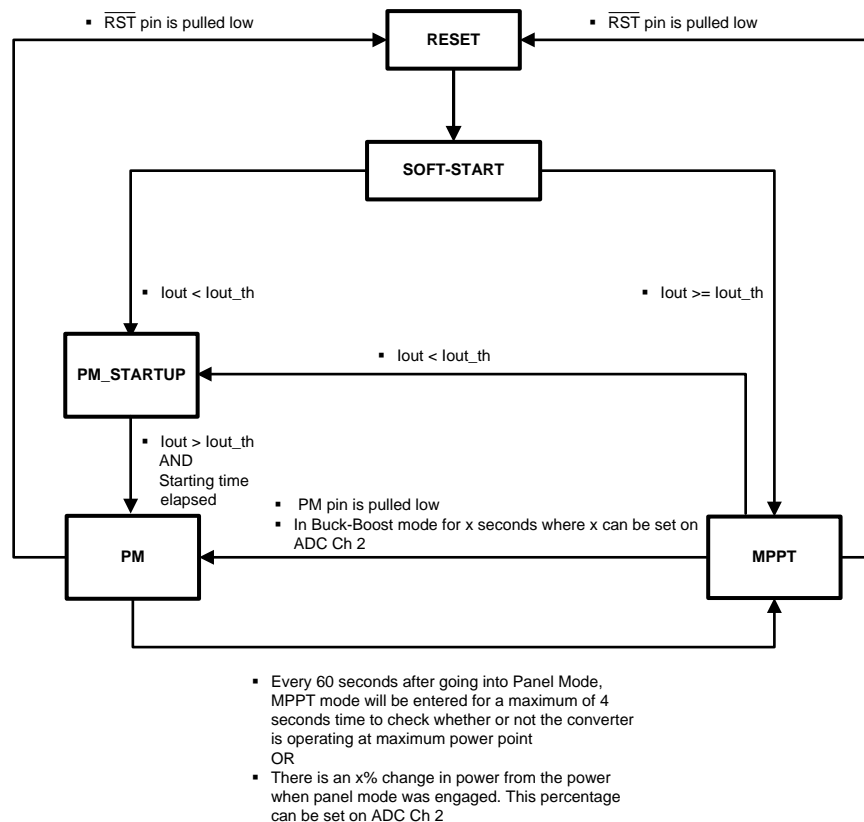

Figure 8. High Level State Diagram for Startup

### STARTUP

SM72445 has a soft start feature that will ramp its output voltage for a time of 250ms if the bridge is configured to run at 215kHz and up to 500ms if the bridge is configured for 110kHz.

If no output current is detected during soft-start time, the device will then enter Panel Mode for 60 seconds. A counter will start once the minimum output current threshold is met (set by ADC input channel 4, pin A4). During these 60 seconds, any variation on the output power will not cause the chip to enter MPPT mode. Once 60 seconds have elapsed, the unit will enter operational PM mode and the pre-determined power level variation at the output will engage the chip in MPPT mode.

If the output current is greater than the current threshold set at A/D Channel 6 (A6) during soft-start, the chip will then engage in MPPT mode and will not be subject to the start-up delay.

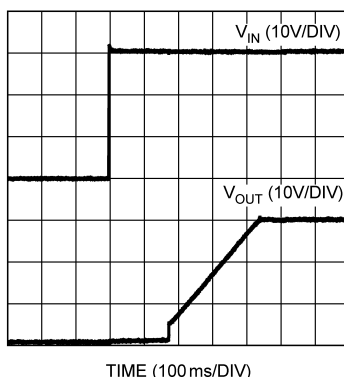

**Figure 9. Startup Sequence**

## MAXIMUM OUTPUT VOLTAGE

The maximum output voltage on the SM72445 is set by the resistor divider ratio on pin A0. (Please refer to [Figure 2](#) Typical Application Circuit).

The value of the voltage on pin A0 is sampled and stored by the ADC of the SM72445 at start-up and after reset events. While voltage on pin AVOUT is above the voltage set at pin A0, the duty cycle of the converter will be reduced every MPPT cycle (1ms-2ms depending on the set switching frequency). This is true when the converter is running in MPPT state or during Soft-Start. When the unit is in Panel Mode (PM) or in Startup Panel Mode (PM\_Startup) there is no control on the output voltage and the device will not react to the presence of a voltage on AVOUT higher than the A0 setpoint. See [Figure 8](#) for more details on the different states of operation.

This means that the voltage limit setting cannot be used to ensure overall maximum output voltage for the system: there will be times during Panel Mode operation and Stand-by mode operation when the output will increase above the programmed output voltage if the input (solar panel) gets over that voltage limit. Therefore, the maximum output voltage threshold set by programming A0 is only valid if its value is higher than the maximum input voltage (solar panel in open circuit at coldest operating point). If over-voltage protection needs to be implemented, it must be done using external components. For example, a voltage comparator with its output connected to the reset pin of the SM72445 is one possible implementation.

The maximum output voltage is always enforced during MPPT operation of the IC.

The following equation sets the maximum output voltage:

$$V_{OUT\_MAX} = 5 \times \frac{RB1}{RT1 + RB1} \times \frac{(RFB1 + RFB2)}{RFB2}$$

Where RT1 and RB1 are the resistor divider on the ADC pin A0 and RFB1 and RFB2 are the output voltage sense resistors. A typical value for RFB2 is about 2 kΩ

## CURRENT LIMIT SETTING

Maximum output current can be set by changing the resistor divider on A4 (pin 18). Refer to [Figure 2](#). Overcurrent at the output is detected when the voltage on AIOU (pin 21) equals the voltage on A4 (pin 18). The voltage on A4 can be set by a resistor divider connected to 5V whereas the voltage on AIOU can be set by a current sense amplifier.

## AVIN PIN

AVIN is an A/D input to sense the input voltage of the SM72445. A resistor divider can be used to scale max voltage to about 4V, which is 80% of the full scale of the A/D input.



## CONFIGURABLE SETTINGS

A/D pins A0, A2, A4, and A6 are used to configure the behavior of the SM72445 by adjusting the voltage applied to them through resistor dividers as shown in [Figure 2](#), where RT1 to RT4 should be in the range of 20 k $\Omega$ .

The voltages of the configuration pins are read and the operating mode is then set at start-up and after each reset of the device.

Three different frequencies for the PWM operation of the H-bridge as well as two different implementations of the Panel Mode switch can be set on the ADC input channel 2 (pin A2). The table below lists the different conditions that a user can select on pin A2. Each frequency has a different associated dead time for the operation of the synchronous switches. When dedicated PM switch modes are used, the unit will stop switching the converter upon entering PM mode and the PM\_OUT pin will switch at a high frequency to provide activation of a dedicated Panel Mode switch. When the H-bridge modes are used, the unit will keep the H-bridge switching at half the operating frequency (to reduce switching losses) and with a total input to output ratio of 1. The dead times are unchanged during this phase.

**Table 1. Programmable Settings on Pin A2**

A2	PWM Frequency setting	Panel Mode Operation
4.69 V	HIGH	Uses dedicated PM switch
4.06 V	HIGH	Uses dedicated PM switch
3.44 V	LOW	Uses H-bridge for PM operation
2.81 V	MED.	Uses H-bridge for PM operation
2.19 V	HIGH	Uses H-bridge for PM operation
1.56 V	LOW	Uses dedicated PM switch
0.94 V	MED.	Uses dedicated PM switch
0.31 V	HIGH	Uses dedicated PM switch

The user can also select the output voltage slew rate, minimum current threshold and duration of Panel Mode after the soft-start period has finished, by changing the voltage level on pin A6 which is the input of ADC channel 6. The slew rate limiter takes control of the duty cycle if the output voltage rises faster than the programmed limit while the unit is running in Boost mode (output voltage higher than input voltage). The device will control the duty cycle so that the output voltage stays within the allowed slew rate. The slew rate is never limited in Buck mode (output voltage lower than input voltage).

**Table 2. Programmable Settings on Pin A6**

A6	Output Voltage Slew Rate Limit	Starting Panel Mode Time	MPPT Exit Threshold (on AIOU or AIIN)	MPPT Start Threshold (on AIOU)	Starting boost ratio
4.69 V	10V/1.2s	Not applicable	0 V	0 V	N/A
4.06 V	10V/1.2s	60s	0.006xVDDA	0.010xVDDA	1:1
3.44 V	10V/1.2s	0s	0.023xVDDA	0.039xVDDA	1:1
2.81 V	10V/1.2s	120s	0.023xVDDA	0.039xVDDA	1:1
2.19 V	10V/1.2s	Not applicable	0.006xVDDA	0.010xVDDA	1:1.2
1.56 V	10V/1.2s	60s	0.023xVDDA	0.039xVDDA	1:1
0.94 V	10V/0.6s	60s	0.023xVDDA	0.039xVDDA	1:1
0.31 V	No slew rate limit	60s	0.023xVDDA	0.039xVDDA	1:1

## PARAMETER DEFINITIONS

**Output Voltage Slew Rate Limit Settling Time:** Time constant of the internal filter used to limit output voltage change. At the fast slew rate, the output voltage will be held for 60 ms for every 1V increase, whereas in the slow slew rate, the output voltage will be held for 120ms for every 1V increase. (See [Figure 10](#)).

**Starting PM Time:** After initial power-up or reset, the output soft-starts and then enters Panel Mode for this amount of time.

**MPPT Exit Threshold and MPPT Start Threshold:** These are the hysteretic thresholds for `lout_th` read on pin A1OUT. The values are expressed as a fraction of the voltage at pin VDDA. A1OUT is the output current sensing pin and should be connected to the output of a current sense amplifier. For example, with a current sense amplification of 0.5V/A provided by an external current sense resistor and amplifier and assuming VDDA=5V and A6=0.94V, the output current threshold to bring the device out of stand-by mode will be 0.39A.

**Starting Boost Ratio:** This is the end-point of the soft-start voltage ramp expressed as a ratio of VOUT/VIN. 1:1 ratio means it stops when  $V_{out} = V_{in}$ , whereas a 1:1.2 ratio means it stops when  $V_{out} = 1.2 \times V_{in}$ .

## DEAD-TIME

The dead time of the switches to avoid cross conduction of the buck FETs and boost FETs depends on the switching frequency set: it is equal to  $(3/256) \times 1/f_{SWITCH}$ . When the IC is programmed for 215 kHz operation, the dead time between HIA and LOA and between HIB and LOB will be 55ns.

## PANEL MODE PIN (PM)

The SM72445 can be forced into Panel Mode by pulling the PM pin low. One sample application is to connect this pin to the output of an external temperature sensor; therefore whenever an over-temperature condition is detected the chip will enter Panel Mode.

Once Panel Mode is enabled, either when the unit is running in MPPT mode with a 1:1 conversion ratio or when PM is pulled low, the PM\_OUT pin will output a 440 kHz square wave signal. Using a gate driver and transformer, this square wave signal can then be used to drive a Panel Mode FET as shown in Figure 11.

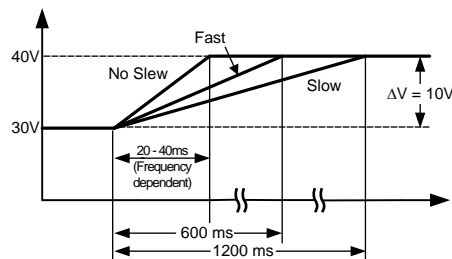

Figure 10. Slew Rate Limitation Circuit

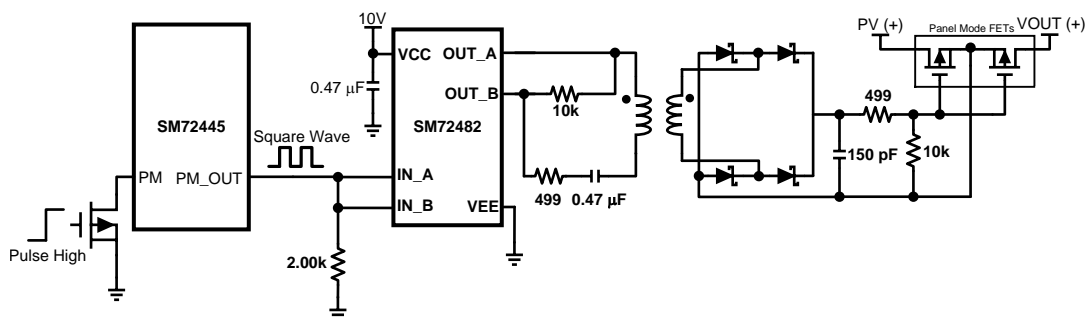

Figure 11. Sample Application for Panel Mode Operation

## RESET PIN

When the reset pin is pulled low, the chip will cease its normal operation and turn-off all of its PWM outputs including the output of PM\_OUT pin. Below is an oscilloscope capture of a forced reset condition.

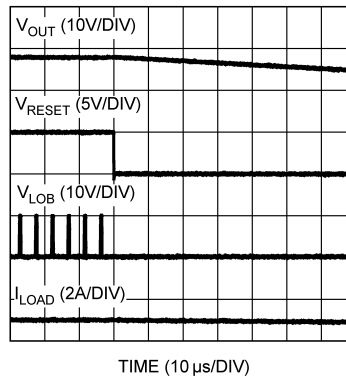

Figure 12. Forced Reset Condition

As seen in Figure 12, the initial value for output voltage and load current are 28V and 1A respectively. After the reset pin is grounded both the output voltage and load current decreases immediately. MOSFET switching on the buck-boost converter also stops immediately. VLOB indicates the low side boost output from the SM72295.

## ANALOG INPUT

An equivalent circuit for one of the ADC input channels is shown in Figure 13. Diode D1 and D2 provide ESD protection for the analog inputs. The operating range for the analog inputs is 0V to  $V_A$ . Going beyond this range will cause the ESD diodes to conduct and result in erratic operation.

The capacitor C1 in Figure 13 has a typical value of 3 pF and is mainly the package pin capacitance. Resistor R1 is the on resistance of the multiplexer and track / hold switch; it is typically 500Ω. Capacitor C2 is the ADC sampling capacitor; it is typically 30 pF. The ADC will deliver best performance when driven by a low-impedance source (less than 100Ω). This is especially important when sampling dynamic signals. Also important when sampling dynamic signals is a band-pass or low-pass filter which reduces harmonic and noise in the input. These filters are often referred to as anti-aliasing filters.

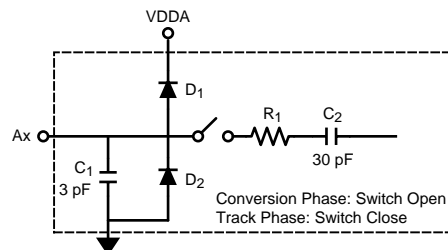

Figure 13. Equivalent Input Circuit

## DIGITAL INPUTS and OUTPUTS

The digital input signals have an operating range of 0V to  $V_A$ , where  $V_A = V_{DDA} - V_{SSA}$ . They are not prone to latch-up and may be asserted before the digital supply  $V_D$ , where  $V_D = V_{DDD} - V_{SSD}$ , without any risk. The digital output signals operating range is controlled by  $V_D$ . The output high voltage is  $V_D - 0.5V$  (min) while the output low voltage is 0.4V (max).

## SCL and SDA

SCL is an input, and SDA is bidirectional with an open-drain output. SCL and SDA do not have internal pull-ups. A “high” level will not be observed on this pin until pull-up current is provided by some external source, typically a pull-up resistor. The choice of resistor value depends on many system factors such as load capacitance and trace length. A typical value of pull-up resistor for SM72445 ranges from 2 kΩ to 10 kΩ. For more information, refer to the I2C Bus specification for selecting the pull-up resistor value. The SCL and SDA outputs can operate while being pulled up to 5V and 3.3V.

## I2C CONFIGURATION REGISTERS

The operation of the SM72445 can be configured through its I2C interface. Complete register settings for I2C lines are shown below.

reg0 Register Description				
Bits	Field	Reset Value	R/W	Bit Field Description
55:40	RSVD	16'h0	R	Reserved for future use.
39:30	ADC6	10'h0	R	Analog Channel 6 (slew rate detection time constant, see adc config worksheet)
29:20	ADC4	10'h0	R	Analog Channel 4 (iout_max: maximum allowed output current)
19:10	ADC2	10'h0	R	Analog Channel 2 (operating mode, see adc_config worksheet)
9:0	ADC0	10'h0	R	Analog Channel 0 (vout_max: maximum allowed output voltage)

reg1 Register Description				
Bits	Field	Reset Value	R/W	Bit Field Description
55:41	RSVD	15'h0	R	Reserved for future use.
40	mppt_ok	1'h0	R	Internal mppt_start signal (test only)
39:30	Vout	10'h0	R	Voltage out
29:20	Iout	10'h0	R	Current out
19:10	Vin	10'h0	R	Voltage in
9:0	Iin	10'h0	R	Current in

reg3 Register Description				
Bits	Field	Reset Value	R/W	Bit Field Description
55:47	RSVD	9'd0	R/W	Reserved
46	override_adcprog	1'b0	R/W	When set to 1'b1, the below override registers used instead of ADC
45	RSVD	1'b0	R/W	Reserved
44:43	RSVD	2'd1	R/W	Reserved
42:40	A2_override	3'd0	R/W	Register override alternative for the three MSBs of ADC2 (bits [9–7]) when reg3[46] is set. This allows frequency and panel mode configuration to be set through I2C
39:30	iout_max	10'd1023	R/W	Register override alternative when reg3[46] is set for maximum current threshold instead of ADC ch4
29:20	vout_max	10'd1023	R/W	Register override alternative when reg3[46] is set for maximum voltage threshold instead of ADC ch0
19:17	tdoff	3'h3	R/W	Dead time Off Time
16:14	tdon	3'h3	R/W	Dead time On time
13:5	dc_open	9'hFF	R/W	Open loop duty cycle (test only)
4	pass_through_sel	1'b0	R/W	Overrides PM pin 28 and use reg3[3]
3	pass_through_manual	1'b0	R/W	Control Panel Mode when pass_through_sel bit is 1'b1
2	bb_reset	1'b0	R/W	Soft reset
1	clk_oe_manual	1'b0	R/W	Enable the PLL clock to appear on pin 5
0	Open Loop operation	1'b0	R/W	Open Loop operation (MPPT disabled, receives duty cycle command from reg 3b13:5); set to 1 and then assert & deassert bb_reset to put the device in openloop (test only)

reg4 Register Description				
Bits	Field	Reset Value	R/W	Bit Field Description
55:32	RSVD	24'd0	R/W	Reserved
31:24	Vout offset	8'h0	R/W	Voltage out offset
23:16	Iout offset	8'h0	R/W	Current out offset
15:8	Vin offset	8'h0	R/W	Voltage in offset
7:0	Iin offset	8'h0	R/W	Current in offset

reg5 Register Description				
Bits	Field	Reset Value	R/W	Bit Field Description
55:40	RSVD	15'd0	R/W	Reserved
39:30	iin_hi_th	10'd40	R/W	Current in high threshold for start
29:20	iin_lo_th	10'd24	R/W	Current in low threshold for start
19:10	iout_hi_th	10'd40	R/W	Current out high threshold for start
9:0	iout_lo_th	10'd24	R/W	Current out low threshold for start

The open loop operation allows the user to set a fixed operating duty cycle (buck or boost) on the converter. The unit will not sense current or voltage in this mode and will perform an internal reset when exiting open loop mode.

The `bb_reset` bit performs a limited reset of the IC. While this bit is set high, the unit will not output any driving signal and will not sense any input. When this bit is transitioned back to zero, the unit will go through its initialization phase according to the programming mode set and possible I2C overrides. The IC will NOT perform a sample of the A0–A6 input when the `bb_reset` bit is cleared.

To change the PWM frequency options the first time after power up, the following programming sequence must be used :

- set `bb_reset` bit (reg3[2]), set over-ride bit (reg3[46]), set to the desired PWM code (reg3[42:40])
- reset `bb_reset` bit, keep over-ride bit, keep the desired PWM code

To change PWM options subsequent to an earlier programming :

- set `bb_reset` bit, reset over-ride bit, set to the desired PWM code
- reset `bb_reset` bit, reset over-ride bit, keep the desired PWM code
- set `bb_reset` bit, set over-ride bit, keep the desired PWM code
- reset `bb_reset` bit, keep over-ride bit, keep the desired PWM code

The switching frequency will be returned to the default external resistor setting after each hard reset of the IC.

The “`tdoff`” and “`tdon`” (REG3[14:19]) parameters allow modification of the dead time. the dead time for the turning on of the synchronous rectifier (affecting buck and boost mode) will be set by  $(td\_on/256)*(1/f\_switch)$ . The default parameter for `td_on` is 3.

The dead time for the turning on of the main switch after the synchronous rectifier as turned off (affecting buck and boost mode) will be set by  $(td\_off/256)*(1/f\_switch)$ . The default parameter for `td_off` is 3. The dead time parameters are returned to their default value after each hard reset of the IC.

The offsets are 8 bit signed numbers which are added or subtracted to the results of the A/D converter and affect the sensed values displayed in Register 0 as well as the thresholds.

Using the I2C port, the user will be able to control the duty cycle of the PWM signal. Input and output voltage and current offsets can also be controlled using I2C on register 4. Control registers are available for additional flexibility.

The thresholds `iin_hi_th`, `iin_lo_th`, `iout_hi_th`, `iout_lo_th`, in reg5 are compared to the values read in by the ADC on the AIIN and AIOU pins. Scaling is set by the scaling of the analog signal fed into AIIN and AIOU. These 10–bit values determine the entry and exit conditions for MPPT. The startup high thresholds set the voltages at pin AIIN and AIOU above which the unit will begin transition from PM\_Startup state to MPPT state. The low thresholds set the voltage below which the unit will transition back to PM\_Startup (stand-by). The initial thresholds are a function of the value programmed in A6. As determined by [Table 2](#), if A6 was between 0 and 1.56V at start-up, the thresholds will be  $0.023*VDDA$  and  $0.039*VDDA$ .

To run the system in Open Loop configuration, the Soft Reset bit must be set then cleared. The ADC channels are inactive when the device is used in Open Loop configuration.

## COMMUNICATING WITH THE SM72445

The SCL line is an input, the SDA line is bidirectional, and the device address can be set by the I2C0, I2C1 and I2C2 pins. Three device address pins allow connection of up to 7 SM72445s to the same I2C master. A pull-up resistor (10kΩ) to a 5V supply is used to set a bit 1 on the device address. Device addressing for slaves are as follows:

I2C0	I2C1	I2C2	Hex
0	0	1	0x1
0	1	0	0x2
0	1	1	0x3
1	0	0	0x4
1	0	1	0x5
1	1	0	0x6
1	1	1	0x7

The data registers in the SM72445 are selected by the Command Register. The Command Register is offset from base address 0xE0. Each data register in the SM72445 falls into one of two types of user accessibility:

- 1) Read only (Reg0, Reg1)
- 2) Write/Read same address (Reg3, Reg4, Reg5)

There are 7 bytes in each register (56 bits), and data must be read and written in blocks of 7 bytes. [Figure 14](#) depicts the ordering of the bytes transmitted in each frame and the bits within each byte. In the read sequence depicted in [Figure 15](#) the data bytes are transmitted in Frames 5 through 11, starting from the LSByte, DATA1, and ending with MSByte, DATA7. In the write sequence depicted in [Figure 16](#), the data bytes are transmitted in Frames 4 through 11. Only the 100kHz data rate is supported. Please refer to “The I2C Bus Specification” version 2.1 (Doc#: 939839340011) for more documentation on the I2C bus.

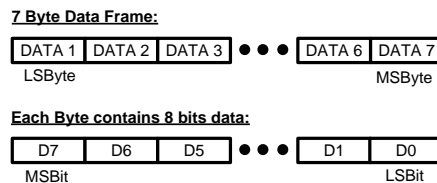

**Figure 14. Endianness Diagram**

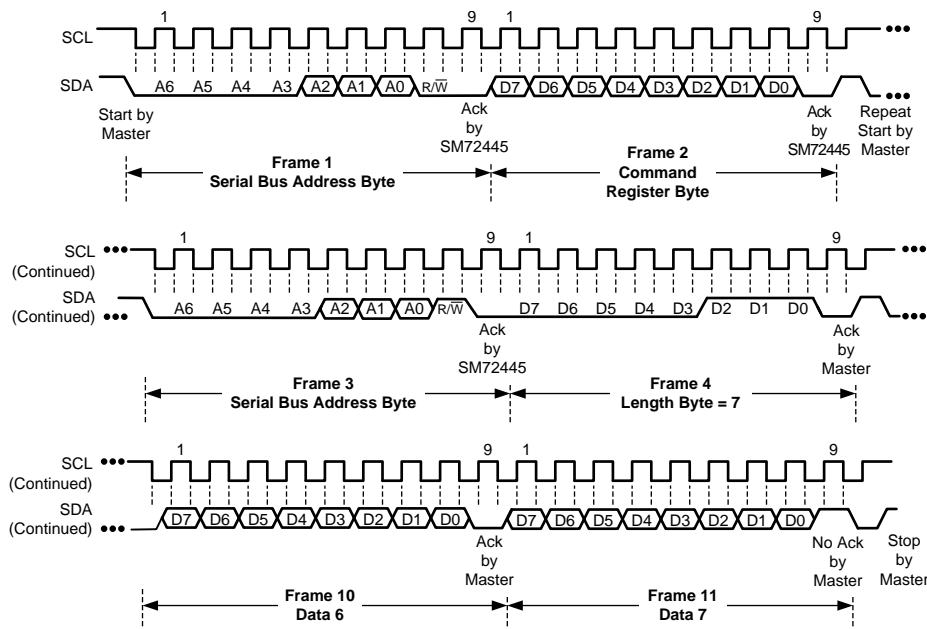

Figure 15. I2C Read Sequence

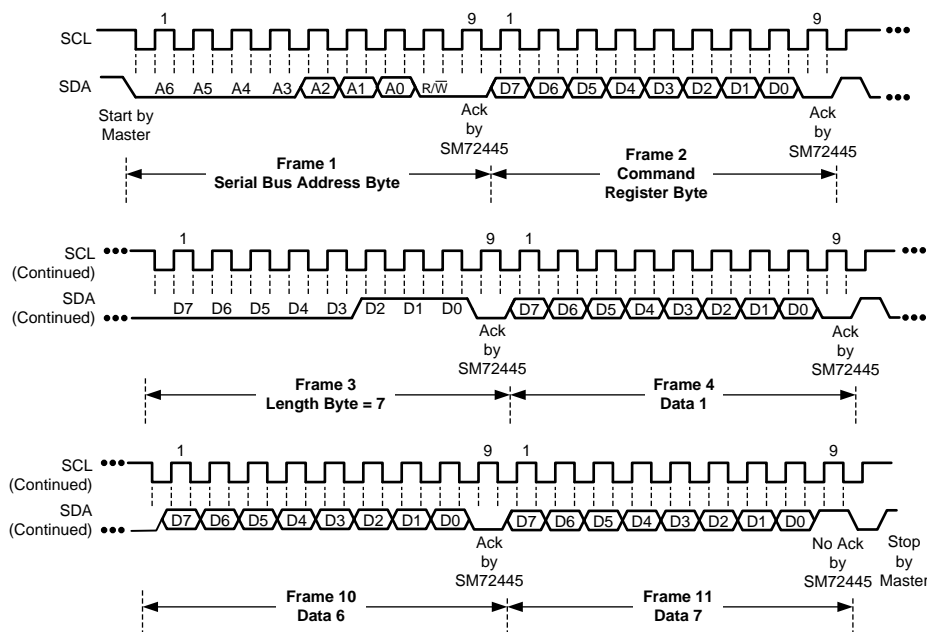





Figure 16. I2C Write Sequence

Noise coupling into digital lines greater than 400 mVp-p (typical hysteresis) and undershoot less than 500 mV below GND, may prevent successful I2C communication with SM72445. I2C no acknowledge is the most common symptom, causing unnecessary traffic on the bus. Although the I2C maximum frequency of communication is rather low (400 kHz max), care still needs to be taken to ensure proper termination within a system with multiple parts on the bus and long printed board traces. Additional resistance can be added in series with the SDA and SCL lines to further help filter noise and ringing. Minimize noise coupling by keeping digital traces out of switching power supply areas as well as ensuring that digital lines containing high speed data communications cross at right angles to the SDA and SCL lines.

**PACKAGING INFORMATION**

Orderable Device	Status (1)	Package Type	Package Drawing	Pins	Package Qty	Eco Plan (2)	Lead/Ball Finish	MSL Peak Temp (3)	Op Temp (°C)	Top-Side Markings (4)	Samples
SM72445MT/NOPB	ACTIVE	TSSOP	PW	28	48	Green (RoHS & no Sb/Br)	CU SN	Level-3-260C-168 HR		SM72445 MT	
SM72445MTE/NOPB	ACTIVE	TSSOP	PW	28	250	Green (RoHS & no Sb/Br)	CU SN	Level-3-260C-168 HR		SM72445 MT	
SM72445MTX/NOPB	ACTIVE	TSSOP	PW	28	2500	Green (RoHS & no Sb/Br)	CU SN	Level-3-260C-168 HR		SM72445 MT	

(1) The marketing status values are defined as follows:

**ACTIVE:** Product device recommended for new designs.

**LIFEBUY:** TI has announced that the device will be discontinued, and a lifetime-buy period is in effect.

**NRND:** Not recommended for new designs. Device is in production to support existing customers, but TI does not recommend using this part in a new design.

**PREVIEW:** Device has been announced but is not in production. Samples may or may not be available.

**OBSOLETE:** TI has discontinued the production of the device.

(2) Eco Plan - The planned eco-friendly classification: Pb-Free (RoHS), Pb-Free (RoHS Exempt), or Green (RoHS & no Sb/Br) - please check <http://www.ti.com/productcontent> for the latest availability information and additional product content details.

**TBD:** The Pb-Free/Green conversion plan has not been defined.

**Pb-Free (RoHS):** TI's terms "Lead-Free" or "Pb-Free" mean semiconductor products that are compatible with the current RoHS requirements for all 6 substances, including the requirement that lead not exceed 0.1% by weight in homogeneous materials. Where designed to be soldered at high temperatures, TI Pb-Free products are suitable for use in specified lead-free processes.

**Pb-Free (RoHS Exempt):** This component has a RoHS exemption for either 1) lead-based flip-chip solder bumps used between the die and package, or 2) lead-based die adhesive used between the die and leadframe. The component is otherwise considered Pb-Free (RoHS compatible) as defined above.

**Green (RoHS & no Sb/Br):** TI defines "Green" to mean Pb-Free (RoHS compatible), and free of Bromine (Br) and Antimony (Sb) based flame retardants (Br or Sb do not exceed 0.1% by weight in homogeneous material)

(3) MSL, Peak Temp. -- The Moisture Sensitivity Level rating according to the JEDEC industry standard classifications, and peak solder temperature.

(4) Only one of markings shown within the brackets will appear on the physical device.

**Important Information and Disclaimer:** The information provided on this page represents TI's knowledge and belief as of the date that it is provided. TI bases its knowledge and belief on information provided by third parties, and makes no representation or warranty as to the accuracy of such information. Efforts are underway to better integrate information from third parties. TI has taken and continues to take reasonable steps to provide representative and accurate information but may not have conducted destructive testing or chemical analysis on incoming materials and chemicals. TI and TI suppliers consider certain information to be proprietary, and thus CAS numbers and other limited information may not be available for release.

In no event shall TI's liability arising out of such information exceed the total purchase price of the TI part(s) at issue in this document sold by TI to Customer on an annual basis.



**TAPE AND REEL INFORMATION**

**QUADRANT ASSIGNMENTS FOR PIN 1 ORIENTATION IN TAPE**

\*All dimensions are nominal

Device	Package Type	Package Drawing	Pins	SPQ	Reel Diameter (mm)	Reel Width W1 (mm)	A0 (mm)	B0 (mm)	K0 (mm)	P1 (mm)	W (mm)	Pin1 Quadrant
SM72445MTE/NOPB	TSSOP	PW	28	250	178.0	16.4	6.8	10.2	1.6	8.0	16.0	Q1
SM72445MTX/NOPB	TSSOP	PW	28	2500	330.0	16.4	6.8	10.2	1.6	8.0	16.0	Q1

**TAPE AND REEL BOX DIMENSIONS**



\*All dimensions are nominal

Device	Package Type	Package Drawing	Pins	SPQ	Length (mm)	Width (mm)	Height (mm)
SM72445MTE/NOPB	TSSOP	PW	28	250	213.0	191.0	55.0
SM72445MTX/NOPB	TSSOP	PW	28	2500	367.0	367.0	38.0

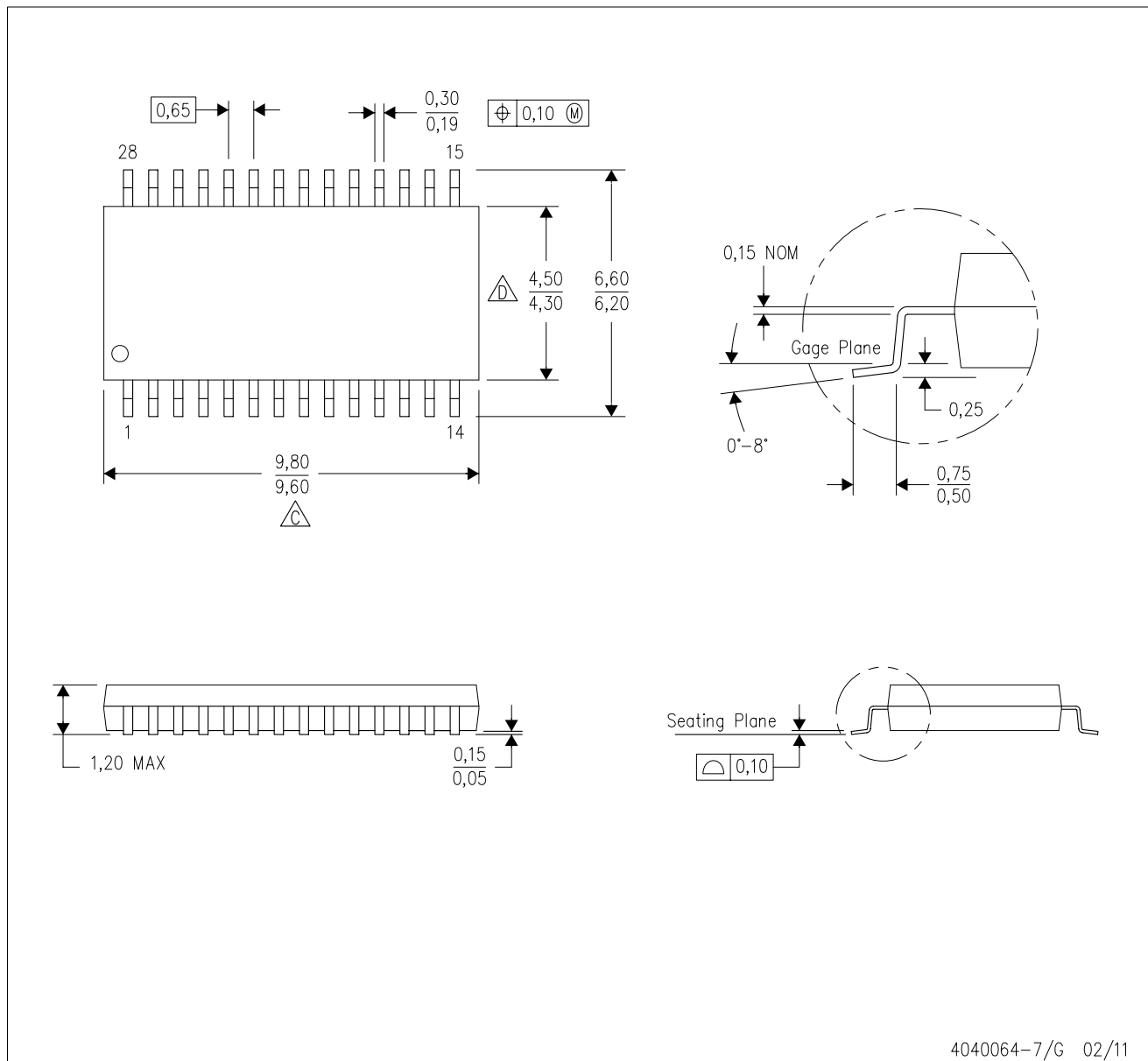

# MECHANICAL DATA

PW (R-PDSO-G28)

PLASTIC SMALL OUTLINE



4040064-7/G 02/11

- NOTES:
- A. All linear dimensions are in millimeters. Dimensioning and tolerancing per ASME Y14.5M-1994.
  - B. This drawing is subject to change without notice.
  -  C. Body length does not include mold flash, protrusions, or gate burrs. Mold flash, protrusions, or gate burrs shall not exceed 0,15 each side.
  -  D. Body width does not include interlead flash. Interlead flash shall not exceed 0,25 each side.
  - E. Falls within JEDEC MO-153

## IMPORTANT NOTICE

Texas Instruments Incorporated and its subsidiaries (TI) reserve the right to make corrections, enhancements, improvements and other changes to its semiconductor products and services per JESD46, latest issue, and to discontinue any product or service per JESD48, latest issue. Buyers should obtain the latest relevant information before placing orders and should verify that such information is current and complete. All semiconductor products (also referred to herein as "components") are sold subject to TI's terms and conditions of sale supplied at the time of order acknowledgment.

TI warrants performance of its components to the specifications applicable at the time of sale, in accordance with the warranty in TI's terms and conditions of sale of semiconductor products. Testing and other quality control techniques are used to the extent TI deems necessary to support this warranty. Except where mandated by applicable law, testing of all parameters of each component is not necessarily performed.

TI assumes no liability for applications assistance or the design of Buyers' products. Buyers are responsible for their products and applications using TI components. To minimize the risks associated with Buyers' products and applications, Buyers should provide adequate design and operating safeguards.

TI does not warrant or represent that any license, either express or implied, is granted under any patent right, copyright, mask work right, or other intellectual property right relating to any combination, machine, or process in which TI components or services are used. Information published by TI regarding third-party products or services does not constitute a license to use such products or services or a warranty or endorsement thereof. Use of such information may require a license from a third party under the patents or other intellectual property of the third party, or a license from TI under the patents or other intellectual property of TI.

Reproduction of significant portions of TI information in TI data books or data sheets is permissible only if reproduction is without alteration and is accompanied by all associated warranties, conditions, limitations, and notices. TI is not responsible or liable for such altered documentation. Information of third parties may be subject to additional restrictions.

Resale of TI components or services with statements different from or beyond the parameters stated by TI for that component or service voids all express and any implied warranties for the associated TI component or service and is an unfair and deceptive business practice. TI is not responsible or liable for any such statements.

Buyer acknowledges and agrees that it is solely responsible for compliance with all legal, regulatory and safety-related requirements concerning its products, and any use of TI components in its applications, notwithstanding any applications-related information or support that may be provided by TI. Buyer represents and agrees that it has all the necessary expertise to create and implement safeguards which anticipate dangerous consequences of failures, monitor failures and their consequences, lessen the likelihood of failures that might cause harm and take appropriate remedial actions. Buyer will fully indemnify TI and its representatives against any damages arising out of the use of any TI components in safety-critical applications.

In some cases, TI components may be promoted specifically to facilitate safety-related applications. With such components, TI's goal is to help enable customers to design and create their own end-product solutions that meet applicable functional safety standards and requirements. Nonetheless, such components are subject to these terms.

No TI components are authorized for use in FDA Class III (or similar life-critical medical equipment) unless authorized officers of the parties have executed a special agreement specifically governing such use.

Only those TI components which TI has specifically designated as military grade or "enhanced plastic" are designed and intended for use in military/aerospace applications or environments. Buyer acknowledges and agrees that any military or aerospace use of TI components which have **not** been so designated is solely at the Buyer's risk, and that Buyer is solely responsible for compliance with all legal and regulatory requirements in connection with such use.

TI has specifically designated certain components as meeting ISO/TS16949 requirements, mainly for automotive use. In any case of use of non-designated products, TI will not be responsible for any failure to meet ISO/TS16949.

### Products

Audio	<a href="http://www.ti.com/audio">www.ti.com/audio</a>
Amplifiers	<a href="http://amplifier.ti.com">amplifier.ti.com</a>
Data Converters	<a href="http://dataconverter.ti.com">dataconverter.ti.com</a>
DLP® Products	<a href="http://www.dlp.com">www.dlp.com</a>
DSP	<a href="http://dsp.ti.com">dsp.ti.com</a>
Clocks and Timers	<a href="http://www.ti.com/clocks">www.ti.com/clocks</a>
Interface	<a href="http://interface.ti.com">interface.ti.com</a>
Logic	<a href="http://logic.ti.com">logic.ti.com</a>
Power Mgmt	<a href="http://power.ti.com">power.ti.com</a>
Microcontrollers	<a href="http://microcontroller.ti.com">microcontroller.ti.com</a>
RFID	<a href="http://www.ti-rfid.com">www.ti-rfid.com</a>
OMAP Applications Processors	<a href="http://www.ti.com/omap">www.ti.com/omap</a>
Wireless Connectivity	<a href="http://www.ti.com/wirelessconnectivity">www.ti.com/wirelessconnectivity</a>

### Applications

Automotive and Transportation	<a href="http://www.ti.com/automotive">www.ti.com/automotive</a>
Communications and Telecom	<a href="http://www.ti.com/communications">www.ti.com/communications</a>
Computers and Peripherals	<a href="http://www.ti.com/computers">www.ti.com/computers</a>
Consumer Electronics	<a href="http://www.ti.com/consumer-apps">www.ti.com/consumer-apps</a>
Energy and Lighting	<a href="http://www.ti.com/energy">www.ti.com/energy</a>
Industrial	<a href="http://www.ti.com/industrial">www.ti.com/industrial</a>
Medical	<a href="http://www.ti.com/medical">www.ti.com/medical</a>
Security	<a href="http://www.ti.com/security">www.ti.com/security</a>
Space, Avionics and Defense	<a href="http://www.ti.com/space-avionics-defense">www.ti.com/space-avionics-defense</a>
Video and Imaging	<a href="http://www.ti.com/video">www.ti.com/video</a>

### TI E2E Community

[e2e.ti.com](http://e2e.ti.com)