

# LMR70503 SIMPLE SWITCHER<sup>®</sup> Buck-Boost Converter For Negative Output Voltage in $\mu$ SMD

Check for Samples: [LMR70503](#)

## FEATURES

- Tiny 8-Bump Thin DSBGA Package: 0.84 mm × 1.615 mm × 0.6 mm
- 2.8 V to 5.5 V Input Voltage Range
- Adjustable Output Voltage: -0.9 V to -5.5 V
- 320 mA Switch Current Limit
- 500 kHz Minimum Switching Frequency
- Ground Referred Enable Input
- Under Voltage Lock Out (UVLO)
- No External Compensation
- Internal Soft Start
- 1  $\mu$ A Shutdown Supply Current
- Small Output Voltage Ripple
- WEBENCH<sup>®</sup> Enabled

## APPLICATIONS

- General Purpose Negative Voltage Supply
- Negative Rail / Bias Supply For Op-amp And Data Converters
- LCD Biasing

## PERFORMANCE BENEFITS

- Easy To Use
- Tiny Overall Solution Size Reduces System Cost

## DESCRIPTION

The LMR70503 is a buck-boost converter with adjustable negative output voltage in a tiny 8-bump thin DSBGA package. Its unique control method is designed to provide fast transient response, low output noise, high efficiency, and tight regulation in the smallest possible PCB area. The LMR70503 has built in soft start, peak current limit, minimum switching frequency, and Under Voltage Lock Out (UVLO), with no external compensation required. For ease of use, the Enable pin is referred to the IC ground, instead of the lowest potential of the IC: the negative output voltage.

## System Performance

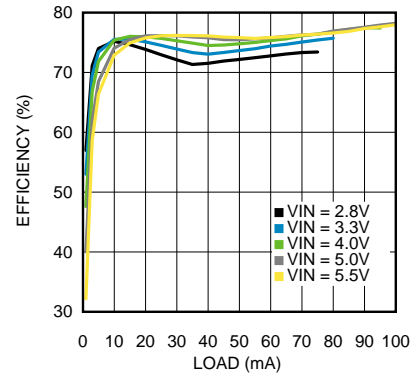
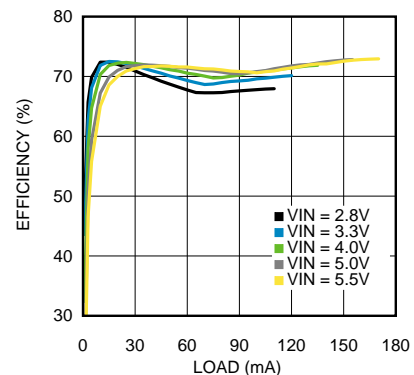
**Figure 1. Efficiency,  $V_{OUT} = -5.0$  V**

**Figure 2. Efficiency,  $V_{OUT} = -2.5$  V**

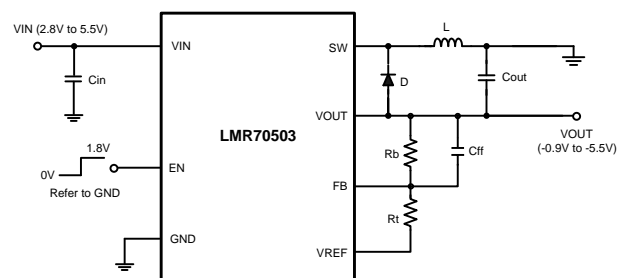
## Typical Application Circuit



Please be aware that an important notice concerning availability, standard warranty, and use in critical applications of Texas Instruments semiconductor products and disclaimers thereto appears at the end of this data sheet.

SIMPLE SWITCHER, WEBENCH are registered trademarks of Texas Instruments.  
All other trademarks are the property of their respective owners.

Connection Diagram

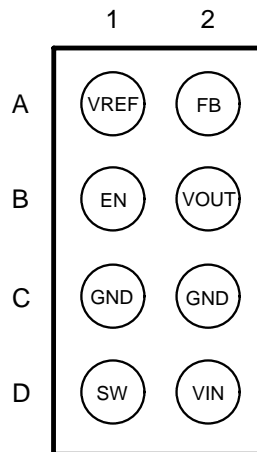

Figure 3. LMR70503 Bump Locations - Top View

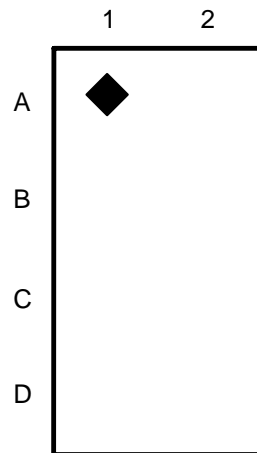

Figure 4. LMR70503 Package Marking - Top View (Diamond Denotes Bump A1)

PIN DESCRIPTIONS

Pin Number	Name	Description
A1	VREF	Reference voltage output; connect to the bottom feedback resistor.
B1	EN	Active high enable input for the device. Enable voltage level is referred to GND. Device must be enabled only with the presence of valid VIN (2.8 V to 5.5 V). The peak of the Enable input voltage must always lower than VIN voltage.
C1, C2	GND	Analog ground for internal bias circuitry.
D1	SW	Switch node pin, connected to the internal high side MOSFET. The cathode of the external Schottky diode must be connected as close as possible to this pin, in order to reduce inductance in the discontinuous current path.
A2	FB	FB is connected to VOUT and VREF through two feedback resistors. It is compared to GND to regulate the output voltage.
B2	VOUT	Output voltage. The anode of the external Schottky diode and output filter capacitor(s) should be connected to this pin.
D2	VIN	Power supply input pin, connected to the internal high side MOSFET and powers the internal circuitry.



These devices have limited built-in ESD protection. The leads should be shorted together or the device placed in conductive foam during storage or handling to prevent electrostatic damage to the MOS gates.

## ABSOLUTE MAXIMUM RATINGS<sup>(1)(2)</sup>

V <sub>IN</sub> to GND	-0.5 V to 6.0 V
V <sub>OUT</sub> to GND	-6.5 V to 0.5 V
SW to GND	-6.5 V to V <sub>IN</sub> +0.2 V
EN to GND	-0.5 V to V <sub>IN</sub>
FB to GND	-0.5V to 5.5V
ESD Rating <sup>(3)</sup>	±2 kV
Junction Temperature	150 °C
Storage Temperature Range	-65 °C to 150 °C
For Soldering Specs see: <a href="#">SNOA549</a>	

- (1) Absolute Maximum Ratings indicate limits beyond which damage to the device may occur, including inoperability and degradation of device reliability and/or performance. Functional operation of the device and/or non-degradation at the Absolute Maximum Ratings or other conditions beyond those indicated in the recommended Operating Ratings is not implied. The recommended Operating Ratings indicate conditions at which the device is functional and should not be operated beyond such conditions.
- (2) If Military/Aerospace specified devices are required, please contact the Texas Instruments Sales Office/Distributors for availability and specifications.
- (3) ESD using the human body model which is a 100 pF capacitor discharged through a 1.5 kΩ resistor into each pin. Test method is per JESD22-A114.

## OPERATING RATINGS

Input Voltage Range (V <sub>IN</sub> )	2.8 V to 5.5 V
Output Voltage Range (V <sub>OUT</sub> )	-0.9 V to -5.5 V
Junction Temperature Range (T <sub>J</sub> )	-40°C to 125°C

## ELECTRICAL CHARACTERISTICS

Specifications with standard typeface are for T<sub>J</sub> = 25°C only; limits in bold face type apply over the operating junction temperature (T<sub>J</sub>) range of -40 °C to +125 °C. Typical values represent the most likely parametric norm at T<sub>J</sub> = 25°C, and are provided for reference purposes only. V<sub>IN</sub> = 3.3 V, V<sub>OUT</sub> = -5.0 V, V<sub>EN</sub> = 1.8 V, unless otherwise indicated in the conditions column.

Symbol	Parameter	Conditions	Min <sup>(1)</sup>	Typ <sup>(2)</sup>	Max <sup>(1)</sup>	Units
V <sub>REF</sub>	Reference Voltage	R <sub>REF</sub> =100 kΩ to GND	<b>1.166</b>	1.19	<b>1.214</b>	V
I <sub>SD</sub>	Shutdown Current	EN = 0 V V <sub>IN</sub> = 5.5 V		0.01	<b>1</b>	μA
I <sub>Q</sub>	Quiescent Current	EN = 1.8 V, V <sub>IN</sub> = 5.5 V, No Switching		245	<b>300</b>	μA
UVLO <sub>RISE</sub>	V <sub>IN</sub> Under Voltage Lock Out Threshold - Rising			2.55	<b>2.7</b>	V
UVLO <sub>HYS</sub>	V <sub>IN</sub> Under Voltage Lock Out Hysteresis Band		<b>0.1</b>	0.13		V
V <sub>EN-RISE</sub>	EN Input Voltage Rising Threshold	V <sub>IN</sub> = 5.5 V		1.05	<b>1.2</b>	V
V <sub>EN-HYS</sub>	EN Input Voltage Threshold Hysteresis	V <sub>IN</sub> = 5.5 V	<b>0.1</b>	0.15		V
I <sub>EN</sub>	Enable Current			30		nA
I <sub>FB</sub>	FB pin current			10		nA
F <sub>SW-MIN</sub>	Minimum Switching frequency		<b>400</b>	500		kHz
T <sub>ON-MIN</sub>	Minimum High Side Switch On Time	Load = 0 A		70		ns
R <sub>DS(ON)</sub>	Switch On State Resistance	V <sub>IN</sub> = 2.8V		1.1	<b>2</b>	Ω

- (1) Min and Max limits are 100% production tested at an ambient temperature (T<sub>A</sub>) of 25 °C. Limits over the operating temperature range are specified through correlation using Statistical Quality Control (SQC) methods. Limits are used to calculate Average Outgoing Quality Level (AOQL).
- (2) Typical specifications represent the most likely parametric norm at 25°C operation.

## ELECTRICAL CHARACTERISTICS (continued)

Specifications with standard typeface are for  $T_J = 25^\circ\text{C}$  only; limits in bold face type apply over the operating junction temperature ( $T_J$ ) range of  $-40^\circ\text{C}$  to  $+125^\circ\text{C}$ . Typical values represent the most likely parametric norm at  $T_J = 25^\circ\text{C}$ , and are provided for reference purposes only.  $V_{IN} = 3.3\text{ V}$ ,  $V_{OUT} = -5.0\text{ V}$ ,  $V_{EN} = 1.8\text{ V}$ , unless otherwise indicated in the conditions column.

Symbol	Parameter	Conditions	Min (1)	Typ (2)	Max (1)	Units
$I_{PEAK-CL}$	Switch Peak Current limit <sup>(3)</sup>		<b>270</b>	320	<b>370</b>	mA
$TSD_{TH-HIGH}$	Thermal Shutdown Threshold - Rising	Junction Temperature		165		$^\circ\text{C}$
$TSD_{HYS}$	Thermal Shutdown Hysteresis Band	Junction Temperature		10		$^\circ\text{C}$

- (3) The switch peak current limit is internally trimmed. The actual peak current limit observed on the applications are dependant on the input voltage  $V_{IN}$ , inductance value L and junction temperature  $T_J$ .

### TYPICAL PERFORMANCE CHARACTERISTICS

Unless otherwise specified, the following conditions apply:  $V_{IN} = 3.3\text{ V}$ ,  $V_{OUT} = -5.0\text{ V}$ ,  $V_{EN} = 1.8\text{ V}$ ,  $C_{IN} = 10\text{ }\mu\text{F}$  6.3 V X5R ceramic capacitor;  $C_{OUT} = 2 \times 22\text{ }\mu\text{F}$  6.3 V X5R ceramic capacitor;  $L = 6.8\text{ }\mu\text{H}$  (VLS2012ET-6R8M);  $T_{AMBIENT} = 25\text{ }^\circ\text{C}$ .

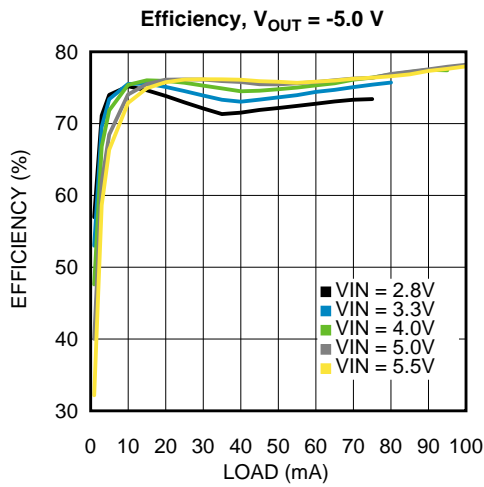

Figure 5.

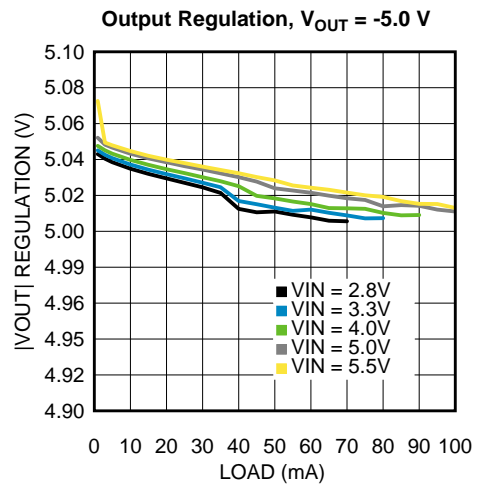

Figure 6.

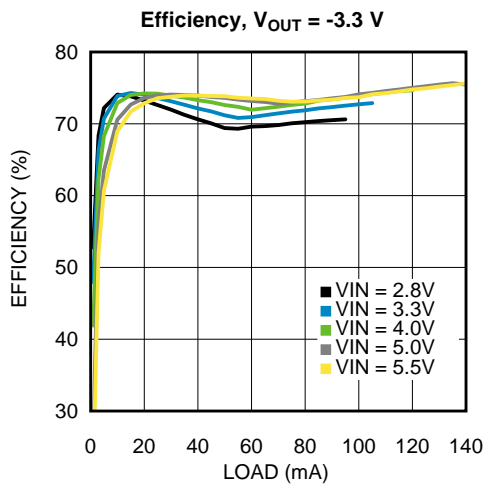

Figure 7.

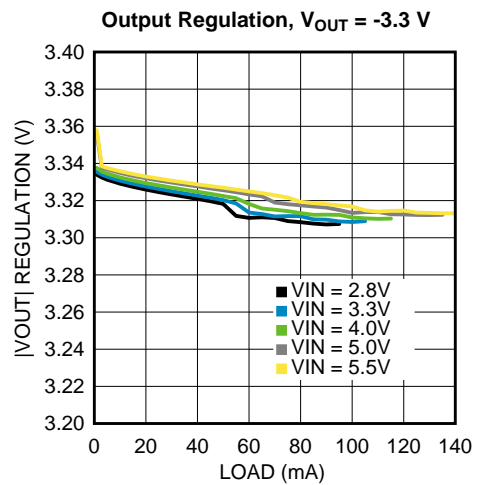

Figure 8.

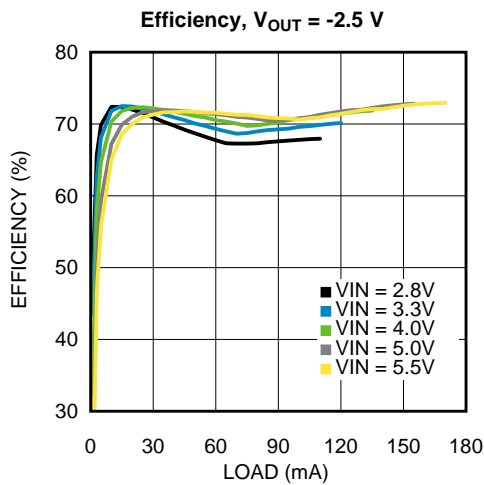

Figure 9.

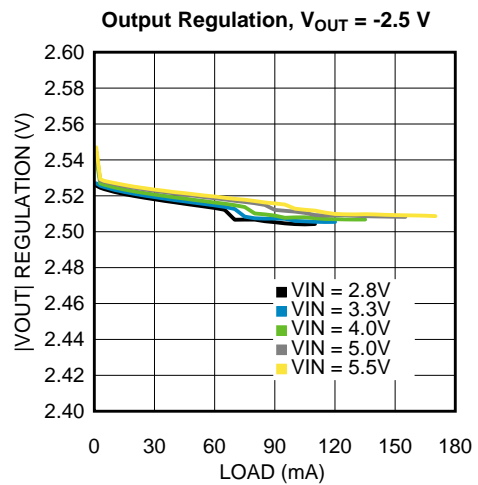

Figure 10.

**TYPICAL PERFORMANCE CHARACTERISTICS (continued)**

Unless otherwise specified, the following conditions apply:  $V_{IN} = 3.3\text{ V}$ ,  $V_{OUT} = -5.0\text{ V}$ ,  $V_{EN} = 1.8\text{ V}$ ,  $C_{IN} = 10\text{ }\mu\text{F}$  6.3 V X5R ceramic capacitor;  $C_{OUT} = 2 \times 22\text{ }\mu\text{F}$  6.3 V X5R ceramic capacitor;  $L = 6.8\text{ }\mu\text{H}$  (VLS2012ET-6R8M);  $T_{AMBIENT} = 25\text{ }^\circ\text{C}$ .

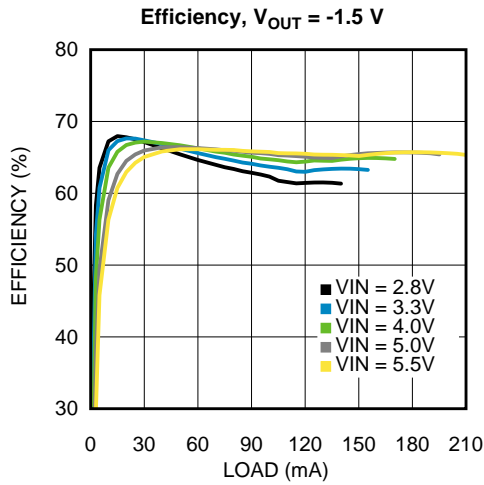

Figure 11.

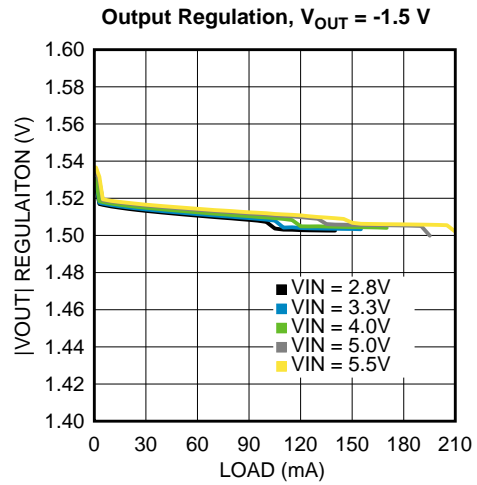

Figure 12.

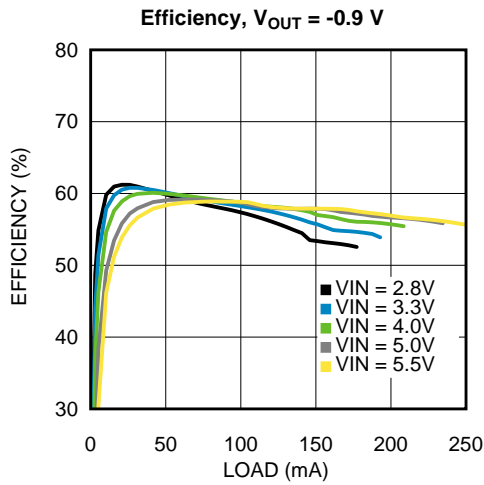

Figure 13.

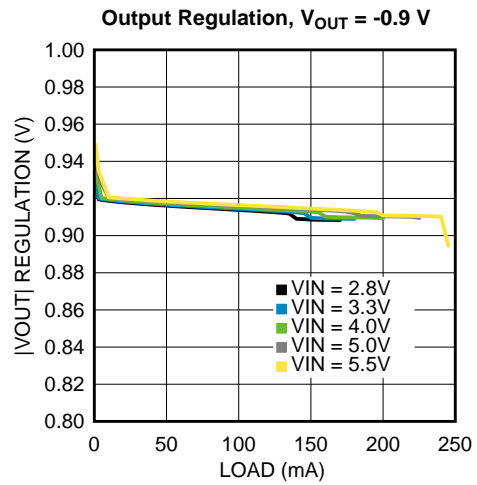

Figure 14.

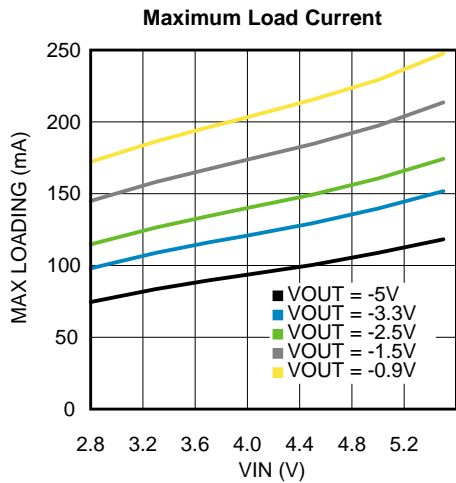

Figure 15.

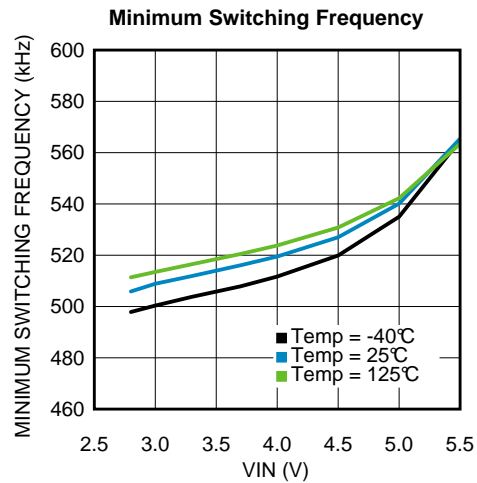

Figure 16.

**TYPICAL PERFORMANCE CHARACTERISTICS (continued)**

Unless otherwise specified, the following conditions apply:  $V_{IN} = 3.3\text{ V}$ ,  $V_{OUT} = -5.0\text{ V}$ ,  $V_{EN} = 1.8\text{ V}$ ,  $C_{IN} = 10\text{ }\mu\text{F}$  6.3 V X5R ceramic capacitor;  $C_{OUT} = 2 \times 22\text{ }\mu\text{F}$  6.3 V X5R ceramic capacitor;  $L = 6.8\text{ }\mu\text{H}$  (VLS2012ET-6R8M);  $T_{AMBIENT} = 25\text{ }^\circ\text{C}$ .

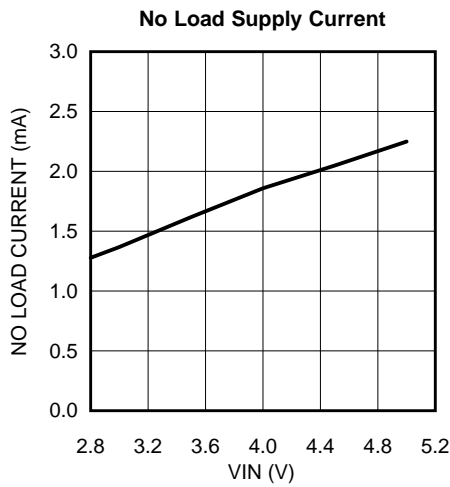

Figure 17.

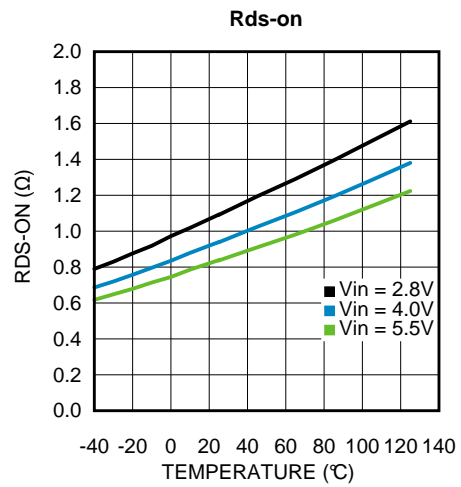

Figure 18.

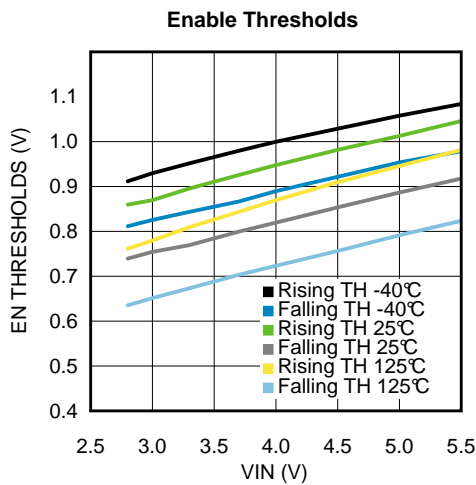

Figure 19.

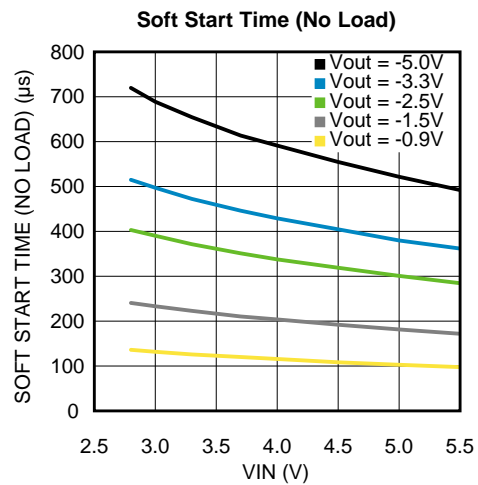

Figure 20.

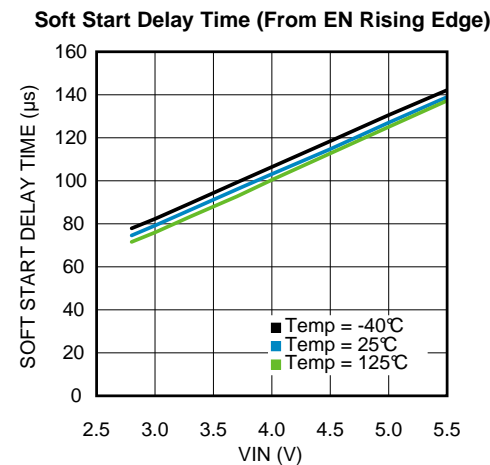

Figure 21.

**Soft Off Time, VOUT = -5.5 V (No Load, From EN Falling Edge)**

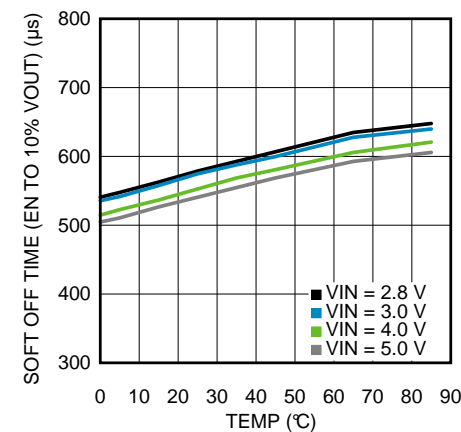

Figure 22.

**TYPICAL PERFORMANCE CHARACTERISTICS (continued)**

Unless otherwise specified, the following conditions apply:  $V_{IN} = 3.3\text{ V}$ ,  $V_{OUT} = -5.0\text{ V}$ ,  $V_{EN} = 1.8\text{ V}$ ,  $C_{IN} = 10\text{ }\mu\text{F}$  6.3 V X5R ceramic capacitor;  $C_{OUT} = 2 \times 22\text{ }\mu\text{F}$  6.3 V X5R ceramic capacitor;  $L = 6.8\text{ }\mu\text{H}$  (VLS2012ET-6R8M);  $T_{AMBIENT} = 25\text{ }^\circ\text{C}$ .

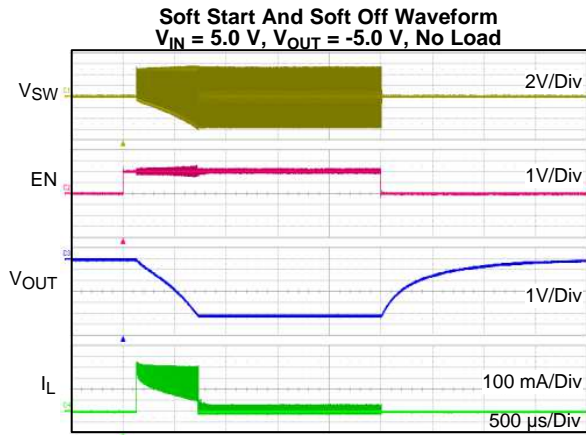

Figure 23.

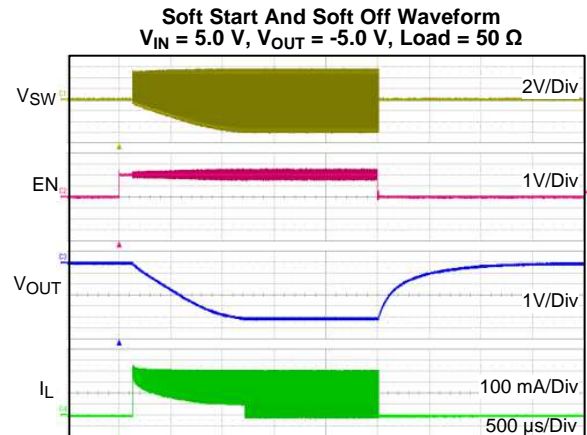

Figure 24.

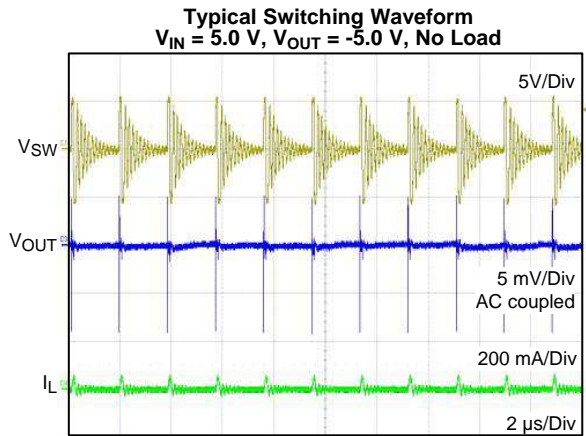

Figure 25.

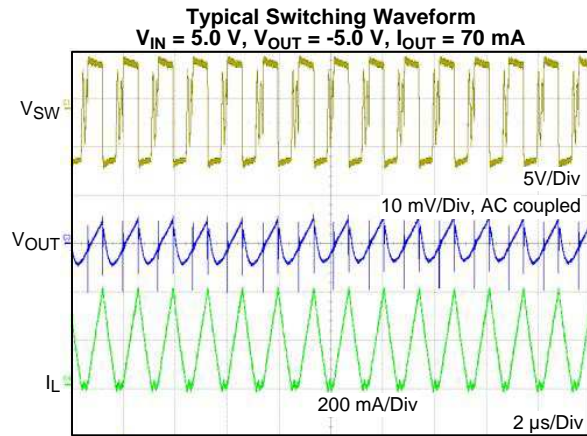

Figure 26.

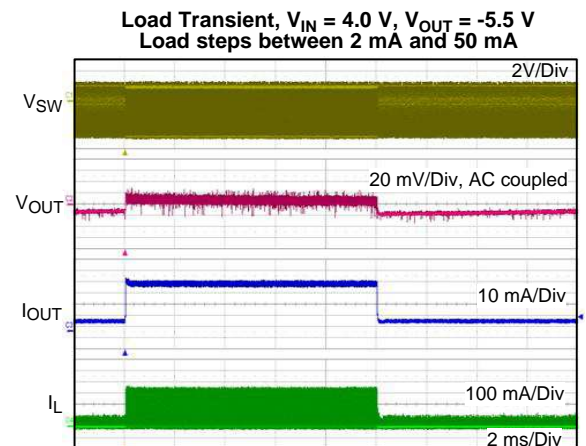

Figure 27.

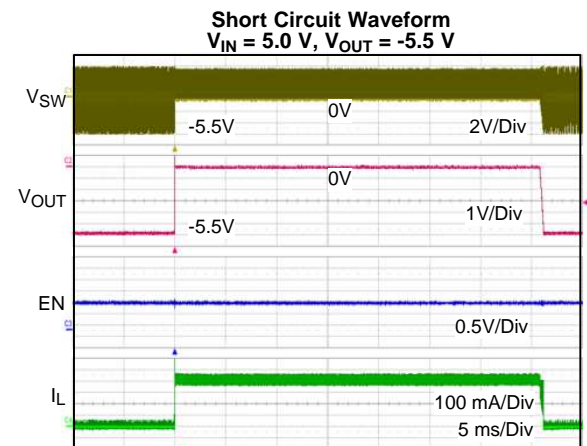
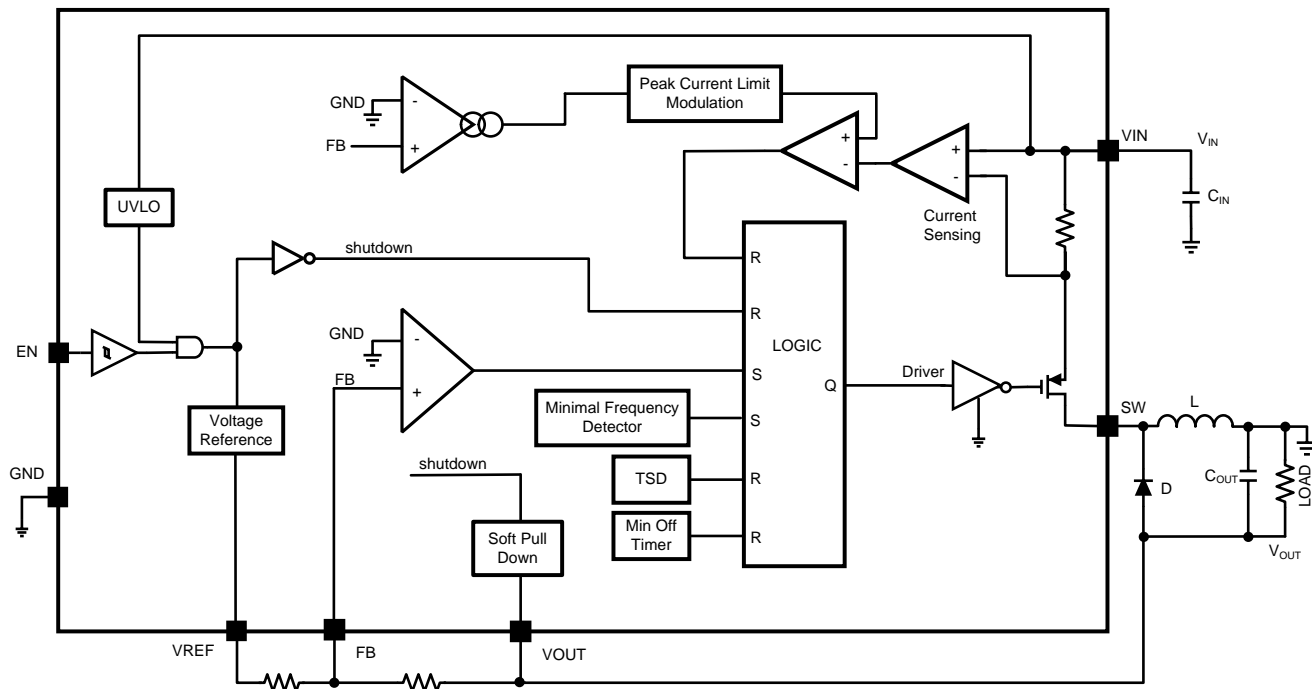

Figure 28.



BLOCK DIAGRAM



## OPERATING DESCRIPTION

The LMR70503 integrates an inverting buck-boost controller and a high-side MOSFET in one tiny 8-bump thin DSBGA package. A simplified buck-boost converter schematic is shown in [Figure 29](#).

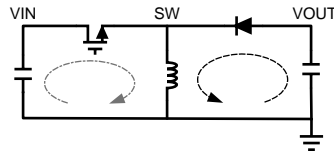

**Figure 29. Buck Boost Converter**

The LMR70503 controller incorporates a unique peak current mode control method with a minimum switching frequency limit. The integrated switch is turned off when its current crosses the peak current limit, while it is turned on when the magnitude of  $V_{OUT}$  droops below a threshold. When the switch is off, the inductor current goes through the diode and charges the output capacitor(s). With fixed peak current limit, the switching frequency decreases with decreased load current. At light load, the switching frequency will decrease to the audible frequency range, which is not acceptable in many applications. The LMR70503 is designed to operate with peak current mode control and limit the switching frequency to 500 kHz (typical) minimum, to avoid audible frequency interference. At light load, when the switching frequency drops to the minimum, the inductor current limit is reduce instead of frequency to maintain regulation. The LMR70503 also incorporates an internal dummy load to compensate for the extra charges in the minimum ON-time ( $T_{ON-MIN}$ ) condition. More details on the LMR70503 operation are described in the later sessions. Typical switching waveforms in discontinuous conduction mode (DCM) and continuous conduction mode (CCM), including the inductor current, the switch node voltage and the output voltage ripple (absolute value), are shown in [Figure 30](#).

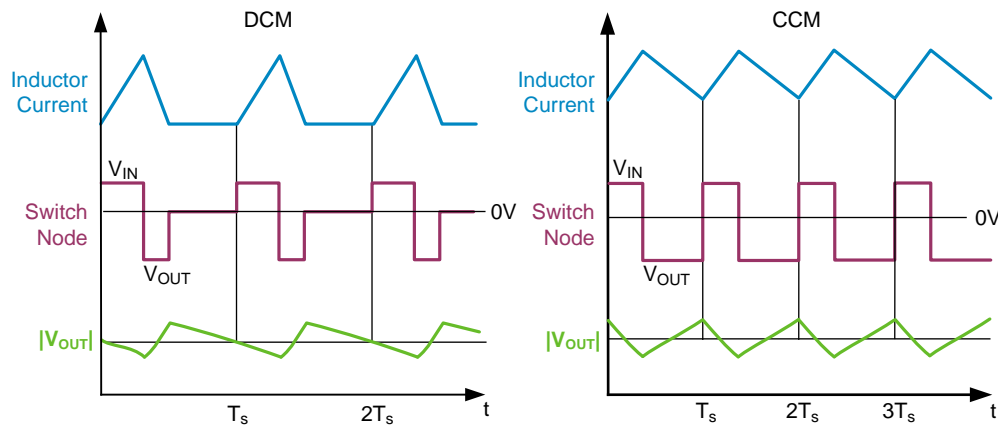

**Figure 30. Typical Waveforms In Buck Boost Converter**

[Figure 31](#) illustrates the switching frequency, the peak current limit, the output voltage and the dummy load with different load current. More details on each operation mode will be described later.

1. No load to very light load: high side switch is turned on for  $T_{ON-MIN}$ ; switching frequency is limited at the minimum switching frequency; and the dummy load is turned on.
2. Light load: switching frequency is limited at the minimum switching frequency, peak current limit increases with increased load current; and the dummy load is off.
3. Heavy load: peak current equals the maximum peak current limit; switching frequency increases with increased load current; and the dummy load is off.

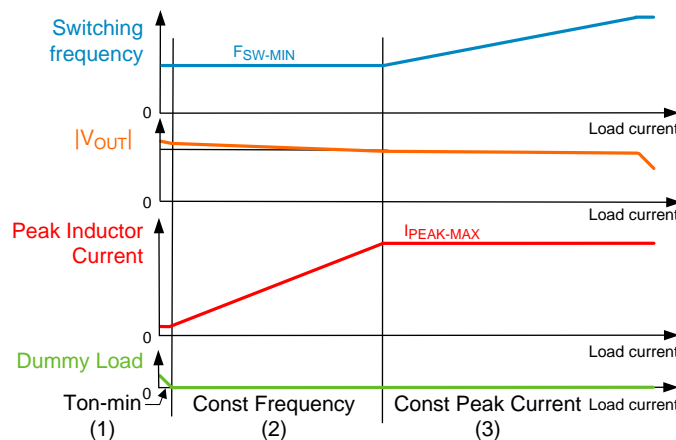

Figure 31. The LMR70503 Operation Modes vs. Load Current

### Minimum Switching Frequency Operation

In a typical peak current mode controlled DC-DC converter, the peak current limit is constant and the switching frequency decreases when load current reduces. To maintain low noise operation and avoid audio frequency interference, the minimum switching frequency of the LMR70503 is limited at 500 kHz typically. At heavy load, the peak current limit remains constant and the switching frequency varies with the load to regulate the output voltage. With reduced loading, the absolute output voltage is going to be charged higher than regulation if the switching frequency cannot decrease accordingly. Therefore, to regulate the output voltage with minimum frequency at light load, the peak current limit is reduced, in proportional to the output voltage offset.

In this mode, as shown in Figure 31, the switching frequency is fixed to the minimum switching frequency, the peak inductor current increases with load current, and the output voltage magnitude has a small offset above regulation.

### Minimum ON-Time and Dummy Load

When load current is near zero, the peak inductor current can not reduce further due to  $T_{ON-MIN}$  of the high side switch. Under such conditions, an internal dummy load is turned on by sensing excessive output voltage offset, which removes the extra charge from the output capacitor(s). In this condition, the switching frequency is fixed to the minimum value. The peak inductor current value is at its minimum value, as shown in Figure 31. The dummy load current is zero when the LMR70503 operates with on time higher than  $T_{ON-MIN}$ .

The minimum peak inductor current is determined by

$$I_{PEAK-MIN} = T_{ON-MIN} \times V_{IN} / L$$

where

- $V_{IN}$  is the supply voltage
- $L$  is the inductance value

(1)

The peak inductor current is higher with higher  $V_{IN}$ . The inductor current falling slew rate is determined by

$$SR_{FALLING} = (|V_{OUT}| + V_F) / L$$

where

- $|V_{OUT}|$  is the absolute value of the output voltage
- $V_F$  is the forward voltage drop of the power diode

(2)

At lower  $|V_{OUT}|$ , it takes longer time to discharge the inductor current to zero. Therefore, there is more energy to charge the output capacitor(s). The output voltage will have more offset at higher  $V_{IN}$  and lower  $V_{OUT}$ . The dummy load current is a function of the FB voltage: the more the offset at the FB node, the higher the dummy load current, as shown in Figure 32.

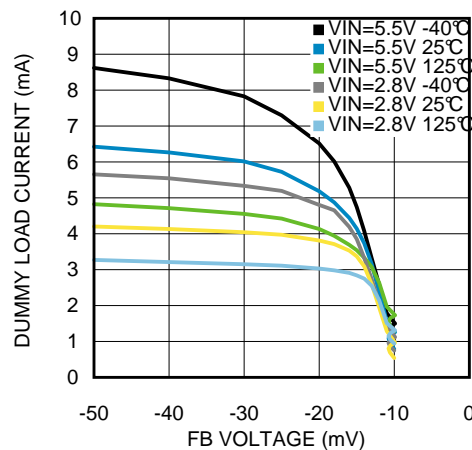

Figure 32. Dummy Load Current vs. FB Voltage

### Constant Peak Current Operation

If the load current increases in the minimum switching frequency mode, the peak current limit will reach the maximum peak current limit ( $I_{PEAK-MAX}$ ). After this point, the LMR70503 behaves as a constant peak current converter with frequency modulation. The transition load level between the constant frequency mode and the constant peak current mode varies with  $V_{IN}$ ,  $V_{OUT}$  and  $L$ .

The  $I_{PEAK-MAX}$  is trimmed to 320 mA in the LMR70503. Due to propagation delays in the comparator and gate drive, the measured peak inductor current will be higher than the trimmed value. The additional offset on the maximum peak current is proportional to the inductor current rising slope:  $V_{IN} / L$ , approximately. For a typical inductor, the inductance will reduce at hot temperature. Therefore,  $I_{PEAK-MAX}$  is the highest with 5.5 V input voltage at hot temperature.

In the constant peak current operation mode, the switching frequency will increase with the increased load current, until the high side switch off time equals the minimum off-time ( $T_{OFF-MIN}$ ) limit. If the load keeps increasing when the switch operates with  $T_{OFF-MIN}$ ,  $V_{OUT}$  will drop out of regulation due to loading limits of buck-boost type of converters. The maximum loading capability is higher with higher  $V_{IN}$ , larger  $L$ , lower  $V_{OUT}$ , and less losses in the converter. Figure 33 shows the measured maximum load current measured with the typical BOM shown in Table 1. To increase the maximum loading capability with given  $V_{IN}$  and  $V_{OUT}$ , one can choose a higher inductance value and a diode with lower forward voltage drop  $V_F$ .

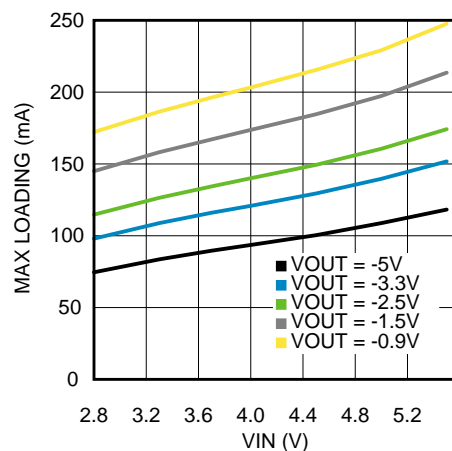

Figure 33. LMR70503 Loading Capability vs.  $V_{IN}$ ,  $L = 6.8 \mu H$

The built-in  $T_{OFF-MIN}$  time is a function of both  $V_{IN}$  and  $V_{OUT}$ , as shown in Figure 34.

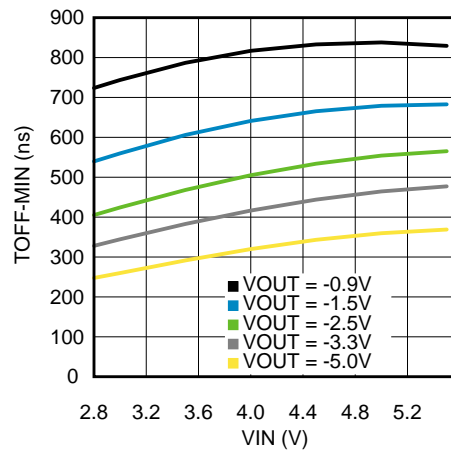

Figure 34. Minimum Off Time vs.  $V_{IN}$  at room temperature

### Enable And UVLO

The LMR70503 features an enable (EN) pin and associated comparator to allow the user to easily sequence the LMR70503 from an external voltage rail, or to manually set the input UVLO threshold. Enable threshold levels are referred to the LMR70503 ground, instead of the lowest potential: the negative output voltage. Enable turning on (rising) and turning off (falling) thresholds are shown in Figure 35.

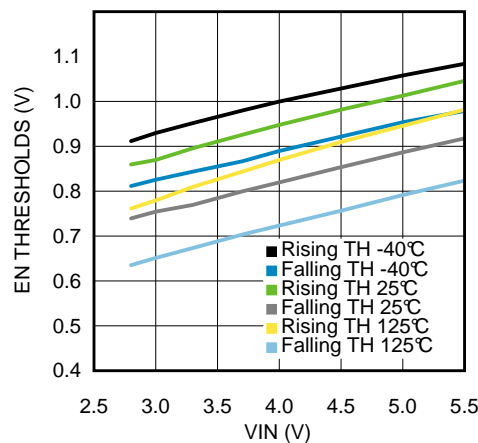

Figure 35. Enable Rising And Falling Thresholds vs.  $V_{IN}$

It is important to ensure that a valid input voltage ( $2.8\text{ V} \leq V_{IN} \leq 5.5\text{ V}$ ) is present on the VIN pin before the EN input is asserted. Also, as stated in the Absolute Maximum Ratings section of this data sheet, the voltage on the EN pin must always be less than  $V_{IN}$ . This applies to both static and dynamic operation, and during start up and shut down sequences. If these precautions are not followed, an internal test mode may be activated; possibly damaging the regulator. The EN input must not be left floating. A resistor divider can be added from VIN to EN if an external enable signal is not available.

An input under voltage lock-out (UVLO) circuit prevents the regulator from turning on when the input voltage is not great enough to properly bias the internal circuitry. The typical UVLO rising threshold is 2.55 V and typical hysteresis band is 0.13 V.

## Soft Start And Soft Off

The LMR70503 begins to operate when EN goes high with the presence of valid  $V_{IN}$ , or  $V_{IN}$  swings below UVLO level and back up with the presence of valid EN voltage. The soft start action is inherent with the maximum peak current limit and minimum off time. During start up, the inductor current rises to the maximum peak current limit, then the high-side switch is turned off for  $T_{OFF-MIN}$  and the output capacitor(s) is charged during this time. Then the high-side turns on to repeat the cycle. After the output voltage is charged to the regulation level, the LMR70503 will operate in steady state. The soft start time will be longer with more output capacitance, and / or lower supply voltage  $V_{IN}$ , and / or more loading during start up. Figure 36 shows soft start vs  $V_{IN}$  with  $L = 6.8 \mu\text{H}$  and no load. Soft-start is reset any time the part is shut down or a thermal shutdown event occurs.

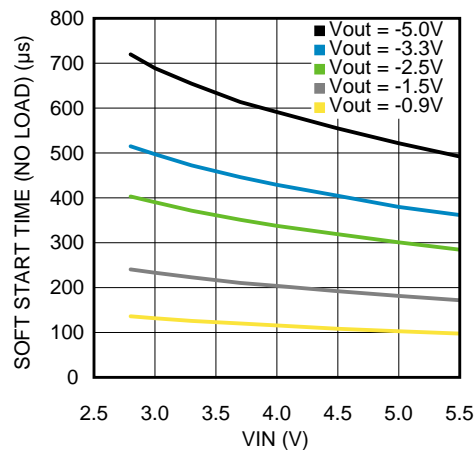

**Figure 36. Soft Start Time (No Load) vs.  $V_{IN}$**

The LMR70503 will shutdown when EN pin voltage goes below the falling threshold, or  $V_{IN}$  goes below UVLO falling threshold. When shutdown, the LMR70503 incorporates an output voltage discharge feature to bring the output voltage to zero volts, regardless of the load current. When the EN input is taken below its lower threshold, an internal MOSFET turns on and discharges the output capacitors. Typical soft off times (from EN falling edge to 10% of  $V_{out}$ ) over  $V_{IN}$  and temperature are shown in Figure 37. Figure 38 shows the typical off time from 90% to 10% of  $V_{out}$ .

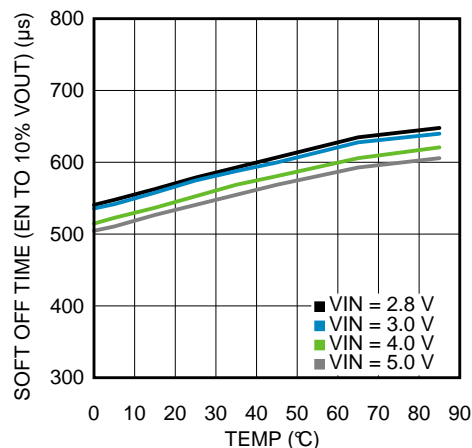

**Figure 37. Soft Off Time (EN Falling Edge To 10% Vout) vs. Temperature,  $V_{OUT} = -5.5 \text{ V}$ , No Load**

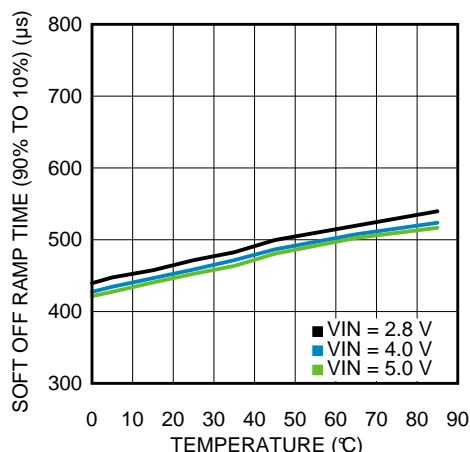

Figure 38. Soft Off Time (90% To 10% V<sub>out</sub>) vs. Temperature, V<sub>OUT</sub> = -5.5 V, No Load

### Short Circuit Protection

Peak current mode control has inherent short circuit protection. The protection level is the maximum inductor current limit level. It varies with V<sub>IN</sub> and temperature due to propagation delays. The minimum off-time limits the current going through the inductor during a short circuit condition.

### Over-Temperature Protection

Internal thermal shutdown (TSD) circuitry protects the LMR70503 should the maximum junction temperature be exceeded. This protection is activated at 165 °C (typical), with the result that the regulator will shutdown until the junction temperature drops below 155 °C (typical). Of course the LMR70503 must not be operated continuously above 125 °C.

### Design Guide

#### Output Voltage Setting

The output voltage of the LMR70503 is programmable by the voltage divider resistors. The reference voltage is typically 1.19 V. To avoid overloading the V<sub>REF</sub> circuitry, the resistor R<sub>T</sub> tied between V<sub>REF</sub> and FB is recommended to be between 20 kΩ and 100 kΩ. With a selected R<sub>T</sub>, R<sub>B</sub> tied between V<sub>OUT</sub> and FB can be found by

$$R_B = R_T * |V_{OUT}| / V_{REF} \quad (3)$$

A feed-forward capacitor C<sub>FF</sub> can be used between V<sub>OUT</sub> and FB nodes to improve transient performance. 10 pF C0G, NP0 type of capacitor is recommended in LMR70503 applications.

#### Input Capacitor And Output Capacitor Selection

The input capacitor selection is based on both input voltage ripple and RMS current. Good quality input capacitors are necessary to limit the ripple voltage at the V<sub>IN</sub> pin while supplying most of the regulator current during switch on-time. Low ESR ceramic capacitors are preferred. A minimum value of 10μF at 6.3 V, is required at the input of the LMR70503. Larger values of input capacitance are desirable to reduce voltage ripple and noise on the input supply.

The output capacitor is responsible for filtering the output voltage and supplying load current during transients and during the power diode off-time. Best performance is achieved with ceramic capacitors. For most applications, a minimum value of 22  $\mu\text{F}$ , 6.3 V capacitor is required at the output of the LMR70503. The percentage of ripple coupled to the FB node can be found by

$$\text{RIPPLE PERCENTAGE} = V_{\text{REF}} / (|V_{\text{OUT}}| + V_{\text{REF}})$$

where

- $|V_{\text{OUT}}|$  is the magnitude of the output voltage
  - $V_{\text{REF}}$  is the reference voltage
- (4)

With lower magnitude  $V_{\text{OUT}}$ , a higher percentage of output voltage ripple is coupled to the FB node. Output voltage ripple is also coupled to the FB node via the feed-forward capacitor  $C_{\text{FF}}$ . Excessive ripple at the FB node may trigger peak current limit modulation causing unstable operation. Higher output capacitance is needed at lower magnitude output voltage. For  $V_{\text{OUT}} = -0.9\text{ V}$ , a minimum of 44  $\mu\text{F}$ , 6.3 V capacitor is required. Avoid using too much capacitance at  $C_{\text{FF}}$ .

A capacitor between  $V_{\text{IN}}$  and  $V_{\text{OUT}}$  also can be used to provide high frequency bypass. This capacitor is equivalent to the output capacitors in the small signal model. It also reduces the output voltage ripple if sufficiency capacitance is used. The voltage rating for this capacitor should be higher than  $V_{\text{IN}} + |V_{\text{OUT}}|$ .

All ceramic capacitors have large voltage coefficients, in addition to normal tolerances and temperature coefficients. To help mitigate these effects, multiple capacitors can be used in parallel to bring the minimum capacitance up to the desired value. This may also help with RMS current constraints by sharing the current among several capacitors. With the LMR70503, ceramic capacitors rated at 6.3 V, or higher, are suitable for all input and output voltage combinations. Many times it is desirable to use an electrolytic capacitor on the input, in parallel with the ceramics. The moderate ESR of this capacitor can help to damp any ringing on the input supply caused by long power leads. This method can also help to reduce voltage spikes that may exceed the maximum input voltage rating of the LMR70503.

### Power Inductor Selection

The power inductor selection is critical to the operation of the LMR70503. It affects the efficiency, the operation mode transition point, the maximum loading capability and the size / cost of the solution. A 4.7  $\mu\text{H}$  or 6.8  $\mu\text{H}$  inductor is recommended for most LMR70503 applications. The maximum loading capability is reduced with smaller inductance value. The no load  $V_{\text{OUT}}$  offset is higher at low  $V_{\text{OUT}}$  with smaller inductance value, due to higher peak current with the same  $T_{\text{ON-MIN}}$ . Higher inductance value usually comes with higher DCR with the same size and cost. Higher DCR will reduce the efficiency especially at heavy load.

The inductor must be rated above the maximum peak current limit to prevent saturation. Good design practice requires that the inductor rating be adequate for the maximum  $I_{\text{PEAK-MAX}}$  over  $V_{\text{IN}}$  and temperature, plus some safety margin. If the inductor is not rated for the maximum expected current, saturation at high current may cause damage to the LMR70503 and/or the power diode. The DCR of the inductor should be as small as possible with given size / cost constraints to achieve optimal efficiency.

### Power Diode Selection

A Schottky type power diode is required for all LMR70503 applications. The parameters of interests include the reverse voltage rating, the DC current rating, the repetitive peak current rating, the forward voltage drop, the reverse leakage current and the parasitic capacitance. In a buck-boost, this diode sees a reverse voltage of :

$$V_{\text{R-DIODE}} = |V_{\text{OUT}}| + V_{\text{IN}} \quad (5)$$

The reverse breakdown voltage rating of the diode should be selected for this value, plus safety margin. A good rule of thumb is to select a diode with a reverse voltage rating of 1.3 times this maximum. Select a diode with a DC current rating at least equal to the maximum load current that will be seen in the application and the repetitive peak current rating higher than  $I_{\text{PEAK-MAX}}$  over  $V_{\text{IN}}$  and temperature. The forward voltage drop of the power diode is a big part of the power loss in a buck-boost converter. It is preferred to be as low as possible. The reverse leakage current and the parasitic capacitance are also part of the power losses in the converter, but usually less pronounced than the forward voltage drop loss. Pay attention to the temperature coefficients of all the parameters. Some of them may vary greatly over temperature and may adversely affect the efficiency over temperature.



## PC Board Layout Guidelines

Board layout is critical for the proper operation of switching power converters. Switch mode converters are very fast switching devices. In such cases, the rapid increase of current combined with the parasitic trace inductance generates unwanted  $L \cdot di/dt$  noise spikes. The magnitude of this noise tends to increase as the output current increases. This noise may turn into electromagnetic interference (EMI) and can also cause problems in device performance. Therefore, care must be taken in layout to minimize the effect of this switching noise. The most important layout rule is to keep the AC current loops as small as possible.

Figure 29 shows the current flow in a buck-boost converter. The two dotted arrows indicate the current paths when the high side switch is on and when the power diode is on, respectively. The components and traces that contain discontinuous currents are critical in PCB layout design, since discontinuous currents contain high  $di/dt$  and high frequency noise. The components that carry critical discontinuous currents include the input capacitor(s), the high side switch, the power diode and the output capacitor(s). These components need to be placed as close as possible to each other and the traces between them must be made as short and wide as possible: place the input capacitor(s) as close as possible to the VIN pin of the LMR70503; place the cathode of the diode as close as possible to the SW pin; the anode of the diode should be as close as possible to the output capacitor(s); the GND end of the output capacitor(s) should be as close as possible to that of the input capacitor(s). Doing so will yield a small loop area, reducing the loop inductance and EMI.

The feedback resistors  $R_B$  and  $R_T$  should be placed as close as possible to the FB pin. Since FB is a high impedance node, noise is likely be coupled to the FB node if the trace is long. The traces from  $V_{OUT}$  to the resistor divider and from the divider to the FB pin should be far away from the discontinuous current path. It is recommended to use 4-layer board with ground plane as an internal layer, route the discontinuous current path on the top layer and the feedback path on the other side of the ground plane. Then the feedback path will be shielded from switching noise.

To avoid functional problems due to layout, review the PCB layout example in Figure 39. It is also recommended to use 1oz copper boards or heavier to help reducing the parasitic inductances of board traces.

## PCB Layout Example

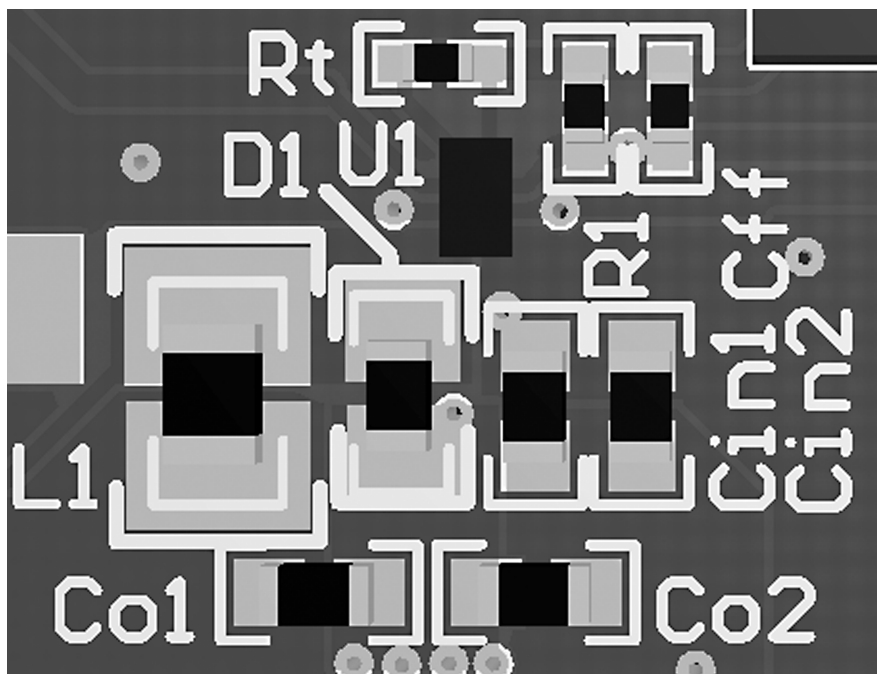
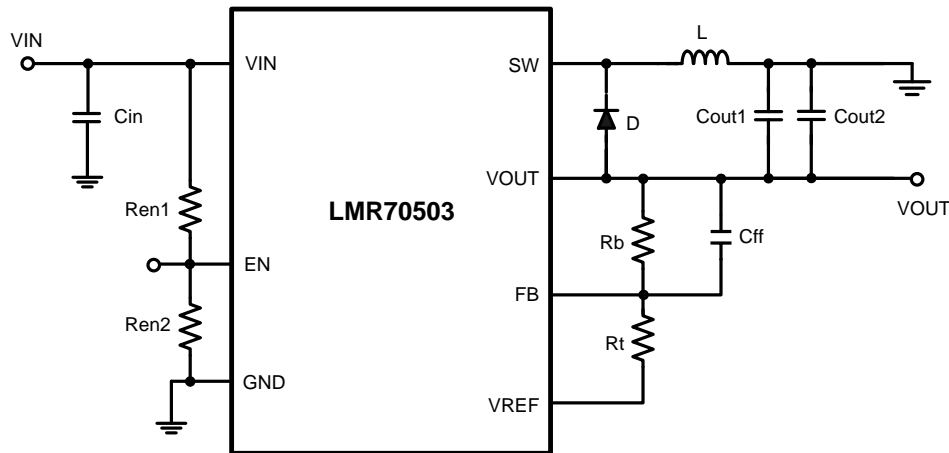

Figure 39. PCB Layout Example (top layer and top overlay)

**LMR70503 Typical Application Circuit**



**LMR70503 Application Circuit Bill of Materials**

$V_{IN}$  = 2.8 V to 5.5 V,  $V_{OUT}$  has options of -0.9 V, -1.5 V, -2.5 V, -3.3 V and -5.0 V. Optimized for minimum solution size.

**Table 1. Bill of Materials**

Designator	Description	Case Size	Manufacturer	Manufacturer P/N
U1	Inverting Buck-Boost	8-bump thin DSBGA	Texas Instruments	LMR70503TM NOPB
$C_{IN}$	Ceramic 10 $\mu$ F 10 V X5R 0603	0603	TDK	C1608X5R1A106M
$C_{OUT1}, C_{OUT2}$	Ceramic 22 $\mu$ F 6.3 V X5R 0603	0603	TDK	C1608X5R0J226M
$C_{ff}$	CAP CER 10PF 50V 5% NP0 0402	0402	Murata	GRM1555C1H100JZ01D
D	Schottky 30 V 500 mA	SOD882	NXP Semi	PMEG3005EL
L	6.8 $\mu$ H, 0.76 A 362 m $\Omega$	2.0*2.0*1.2mm	TDK	VLS2012ET-6R8M
$R_T$	RES, 100k ohm, 1%, 0.063W, 0402	0402	Vishay Dale	CRCW0402100KFKED
$R_B^{(1)}$	422 k $\Omega$ For Vout = -5.0V	0402	Vishay Dale	CRCW0402422KFKED
	274 k $\Omega$ For Vout = -3.3V	0402	Vishay Dale	CRCW0402274KFKED
	210 k $\Omega$ For Vout = -2.5V	0402	Vishay Dale	CRCW0402210KFKED
	127 k $\Omega$ For Vout = -1.5V	0402	Vishay Dale	CRCW0402127KFKED
	75 k $\Omega$ For Vout = -0.9V	0402	Vishay Dale	CRCW040275K0FKED
$R_{EN1}, R_{EN2}$	RES, 20k ohm, 5%, 0.063W, 0402	0402	Vishay Dale	CRCW040220K0JNED

(1)  $R_B$  is represented by R1 in [Figure 39](#).

---

**REVISION HISTORY**

<b>Changes from Original (April 2013) to Revision A</b>	<b>Page</b>
<hr/> <ul style="list-style-type: none"><li>• Changed layout of National Data Sheet to TI format .....</li></ul>	<hr/> <b>18</b>

**PACKAGING INFORMATION**

Orderable Device	Status (1)	Package Type	Package Drawing	Pins	Package Qty	Eco Plan (2)	Lead/Ball Finish	MSL Peak Temp (3)	Op Temp (°C)	Top-Side Markings (4)	Samples
LMR70503TM/NOPB	ACTIVE	DSBGA	YFX	8	250	Green (RoHS & no Sb/Br)	SNAGCU	Level-1-260C-UNLIM		S3	<a href="#">Samples</a>
LMR70503TMX/NOPB	ACTIVE	DSBGA	YFX	8	3000	Green (RoHS & no Sb/Br)	SNAGCU	Level-1-260C-UNLIM		S3	<a href="#">Samples</a>

(1) The marketing status values are defined as follows:

**ACTIVE:** Product device recommended for new designs.

**LIFEBUY:** TI has announced that the device will be discontinued, and a lifetime-buy period is in effect.

**NRND:** Not recommended for new designs. Device is in production to support existing customers, but TI does not recommend using this part in a new design.

**PREVIEW:** Device has been announced but is not in production. Samples may or may not be available.

**OBSOLETE:** TI has discontinued the production of the device.

(2) Eco Plan - The planned eco-friendly classification: Pb-Free (RoHS), Pb-Free (RoHS Exempt), or Green (RoHS & no Sb/Br) - please check <http://www.ti.com/productcontent> for the latest availability information and additional product content details.

**TBD:** The Pb-Free/Green conversion plan has not been defined.

**Pb-Free (RoHS):** TI's terms "Lead-Free" or "Pb-Free" mean semiconductor products that are compatible with the current RoHS requirements for all 6 substances, including the requirement that lead not exceed 0.1% by weight in homogeneous materials. Where designed to be soldered at high temperatures, TI Pb-Free products are suitable for use in specified lead-free processes.

**Pb-Free (RoHS Exempt):** This component has a RoHS exemption for either 1) lead-based flip-chip solder bumps used between the die and package, or 2) lead-based die adhesive used between the die and leadframe. The component is otherwise considered Pb-Free (RoHS compatible) as defined above.

**Green (RoHS & no Sb/Br):** TI defines "Green" to mean Pb-Free (RoHS compatible), and free of Bromine (Br) and Antimony (Sb) based flame retardants (Br or Sb do not exceed 0.1% by weight in homogeneous material)

(3) MSL, Peak Temp. -- The Moisture Sensitivity Level rating according to the JEDEC industry standard classifications, and peak solder temperature.

(4) Multiple Top-Side Markings will be inside parentheses. Only one Top-Side Marking contained in parentheses and separated by a "~" will appear on a device. If a line is indented then it is a continuation of the previous line and the two combined represent the entire Top-Side Marking for that device.

**Important Information and Disclaimer:** The information provided on this page represents TI's knowledge and belief as of the date that it is provided. TI bases its knowledge and belief on information provided by third parties, and makes no representation or warranty as to the accuracy of such information. Efforts are underway to better integrate information from third parties. TI has taken and continues to take reasonable steps to provide representative and accurate information but may not have conducted destructive testing or chemical analysis on incoming materials and chemicals. TI and TI suppliers consider certain information to be proprietary, and thus CAS numbers and other limited information may not be available for release.

In no event shall TI's liability arising out of such information exceed the total purchase price of the TI part(s) at issue in this document sold by TI to Customer on an annual basis.

**TAPE AND REEL INFORMATION**

**QUADRANT ASSIGNMENTS FOR PIN 1 ORIENTATION IN TAPE**

\*All dimensions are nominal

Device	Package Type	Package Drawing	Pins	SPQ	Reel Diameter (mm)	Reel Width W1 (mm)	A0 (mm)	B0 (mm)	K0 (mm)	P1 (mm)	W (mm)	Pin1 Quadrant
LMR70503TM/NOPB	DSBGA	YFX	8	250	178.0	8.4	0.91	1.69	0.7	4.0	8.0	Q1
LMR70503TMX/NOPB	DSBGA	YFX	8	3000	178.0	8.4	0.91	1.69	0.7	4.0	8.0	Q1

**TAPE AND REEL BOX DIMENSIONS**

\*All dimensions are nominal

Device	Package Type	Package Drawing	Pins	SPQ	Length (mm)	Width (mm)	Height (mm)
LMR70503TM/NOPB	DSBGA	YFX	8	250	210.0	185.0	35.0
LMR70503TMX/NOPB	DSBGA	YFX	8	3000	210.0	185.0	35.0

YFX0008

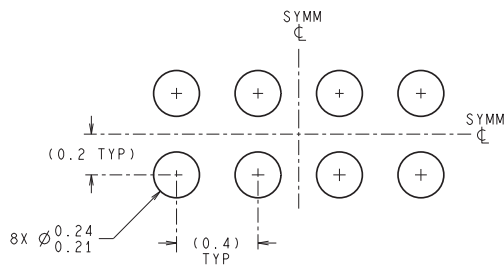

LAND PATTERN RECOMMENDATION

DIMENSIONS ARE IN MILLIMETERS  
DIMENSIONS IN ( ) FOR REFERENCE ONLY

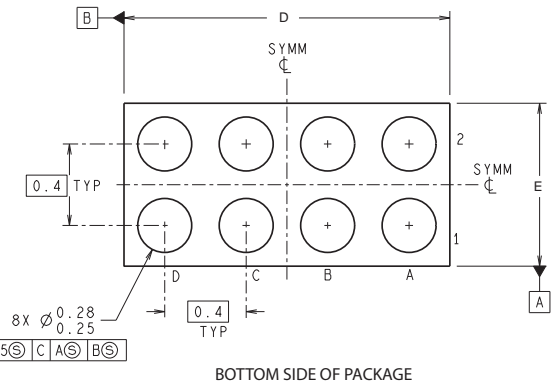
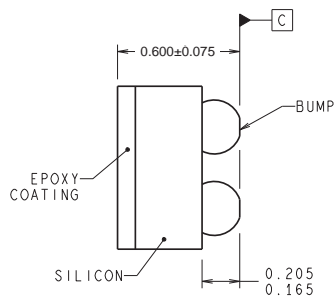
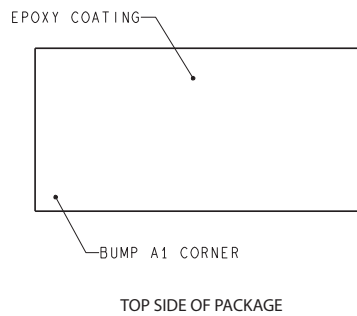

TMP08XXX (Rev A)

D: Max = 1.64 mm, Min = 1.58 mm

E: Max = 0.855 mm, Min = 0.795 mm

4215093/A 12/12

NOTES: A. All linear dimensions are in millimeters. Dimensioning and tolerancing per ASME Y14.5M-1994.  
B. This drawing is subject to change without notice.

## IMPORTANT NOTICE

Texas Instruments Incorporated and its subsidiaries (TI) reserve the right to make corrections, enhancements, improvements and other changes to its semiconductor products and services per JESD46, latest issue, and to discontinue any product or service per JESD48, latest issue. Buyers should obtain the latest relevant information before placing orders and should verify that such information is current and complete. All semiconductor products (also referred to herein as "components") are sold subject to TI's terms and conditions of sale supplied at the time of order acknowledgment.

TI warrants performance of its components to the specifications applicable at the time of sale, in accordance with the warranty in TI's terms and conditions of sale of semiconductor products. Testing and other quality control techniques are used to the extent TI deems necessary to support this warranty. Except where mandated by applicable law, testing of all parameters of each component is not necessarily performed.

TI assumes no liability for applications assistance or the design of Buyers' products. Buyers are responsible for their products and applications using TI components. To minimize the risks associated with Buyers' products and applications, Buyers should provide adequate design and operating safeguards.

TI does not warrant or represent that any license, either express or implied, is granted under any patent right, copyright, mask work right, or other intellectual property right relating to any combination, machine, or process in which TI components or services are used. Information published by TI regarding third-party products or services does not constitute a license to use such products or services or a warranty or endorsement thereof. Use of such information may require a license from a third party under the patents or other intellectual property of the third party, or a license from TI under the patents or other intellectual property of TI.

Reproduction of significant portions of TI information in TI data books or data sheets is permissible only if reproduction is without alteration and is accompanied by all associated warranties, conditions, limitations, and notices. TI is not responsible or liable for such altered documentation. Information of third parties may be subject to additional restrictions.

Resale of TI components or services with statements different from or beyond the parameters stated by TI for that component or service voids all express and any implied warranties for the associated TI component or service and is an unfair and deceptive business practice. TI is not responsible or liable for any such statements.

Buyer acknowledges and agrees that it is solely responsible for compliance with all legal, regulatory and safety-related requirements concerning its products, and any use of TI components in its applications, notwithstanding any applications-related information or support that may be provided by TI. Buyer represents and agrees that it has all the necessary expertise to create and implement safeguards which anticipate dangerous consequences of failures, monitor failures and their consequences, lessen the likelihood of failures that might cause harm and take appropriate remedial actions. Buyer will fully indemnify TI and its representatives against any damages arising out of the use of any TI components in safety-critical applications.

In some cases, TI components may be promoted specifically to facilitate safety-related applications. With such components, TI's goal is to help enable customers to design and create their own end-product solutions that meet applicable functional safety standards and requirements. Nonetheless, such components are subject to these terms.

No TI components are authorized for use in FDA Class III (or similar life-critical medical equipment) unless authorized officers of the parties have executed a special agreement specifically governing such use.

Only those TI components which TI has specifically designated as military grade or "enhanced plastic" are designed and intended for use in military/aerospace applications or environments. Buyer acknowledges and agrees that any military or aerospace use of TI components which have **not** been so designated is solely at the Buyer's risk, and that Buyer is solely responsible for compliance with all legal and regulatory requirements in connection with such use.

TI has specifically designated certain components as meeting ISO/TS16949 requirements, mainly for automotive use. In any case of use of non-designated products, TI will not be responsible for any failure to meet ISO/TS16949.

### Products

Audio	<a href="http://www.ti.com/audio">www.ti.com/audio</a>
Amplifiers	<a href="http://amplifier.ti.com">amplifier.ti.com</a>
Data Converters	<a href="http://dataconverter.ti.com">dataconverter.ti.com</a>
DLP® Products	<a href="http://www.dlp.com">www.dlp.com</a>
DSP	<a href="http://dsp.ti.com">dsp.ti.com</a>
Clocks and Timers	<a href="http://www.ti.com/clocks">www.ti.com/clocks</a>
Interface	<a href="http://interface.ti.com">interface.ti.com</a>
Logic	<a href="http://logic.ti.com">logic.ti.com</a>
Power Mgmt	<a href="http://power.ti.com">power.ti.com</a>
Microcontrollers	<a href="http://microcontroller.ti.com">microcontroller.ti.com</a>
RFID	<a href="http://www.ti-rfid.com">www.ti-rfid.com</a>
OMAP Applications Processors	<a href="http://www.ti.com/omap">www.ti.com/omap</a>
Wireless Connectivity	<a href="http://www.ti.com/wirelessconnectivity">www.ti.com/wirelessconnectivity</a>

### Applications

Automotive and Transportation	<a href="http://www.ti.com/automotive">www.ti.com/automotive</a>
Communications and Telecom	<a href="http://www.ti.com/communications">www.ti.com/communications</a>
Computers and Peripherals	<a href="http://www.ti.com/computers">www.ti.com/computers</a>
Consumer Electronics	<a href="http://www.ti.com/consumer-apps">www.ti.com/consumer-apps</a>
Energy and Lighting	<a href="http://www.ti.com/energy">www.ti.com/energy</a>
Industrial	<a href="http://www.ti.com/industrial">www.ti.com/industrial</a>
Medical	<a href="http://www.ti.com/medical">www.ti.com/medical</a>
Security	<a href="http://www.ti.com/security">www.ti.com/security</a>
Space, Avionics and Defense	<a href="http://www.ti.com/space-avionics-defense">www.ti.com/space-avionics-defense</a>
Video and Imaging	<a href="http://www.ti.com/video">www.ti.com/video</a>

### TI E2E Community

[e2e.ti.com](http://e2e.ti.com)